

Mn/DOT

Roadway Lighting

Design Manual

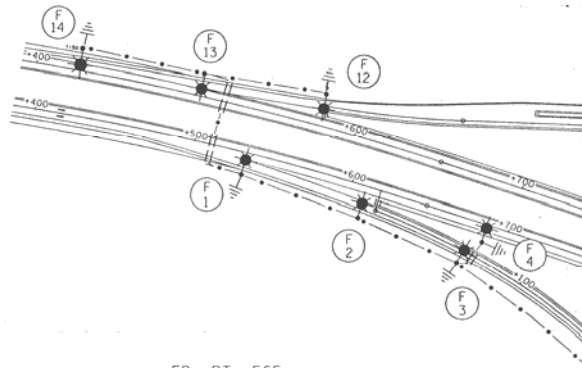

LIGHTING UNIT TYPE 9-40

FD. PT. F6F

LIGHTING STANDARDS AND BASES					
NO.	STATION	LT.	RT.	LOCATION	TYPE
1	41+536	--	--	T.H. 610 E.B.	3-12
2	41+611	--	--	T.H. 610 E.B.	3-12
3	11+059	--	--	RAMP V	2-12
4	41+686	--	--	T.H. 610 E.B.	3-12
5	42+468	--	--	T.H. 610 E.B.	3-12
6	42+543	--	--	T.H. 610 E.B.	3-12
7	42+618	--	--	T.H. 610 E.B.	3-12
8	42+513	--	--	T.H. 610 W.B.	3-12
9	42+438	--	--	T.H. 610 W.B.	3-12
10	2+413	--	--	RAMP U	2-12
11	42+363	--	--	T.H. 610 W.B.	3-12
12	41+577	--	--	T.H. 610 W.B.	3-12
13	41+502	--	--	T.H. 610 W.B.	3-12
14	41+427	--	--	T.H. 610 W.B.	3-12

PLACE LIGHTING UNITS 3 METERS BEHIND BITUMINOUS SHOULDER

CERTIFIED BY *Shirley A. Lovell*
REGISTERED ENGINEER



May 2010

Roadway Lighting Design Manual

May 2010



TABLE OF CONTENTS

1.	LIGHTING BASICS	1-1
1.1	Definition of Terms	1-1
1.2	Purpose of Roadway Lighting.....	1-2
1.2.1	Traffic Engineering Objectives	1-2
1.2.2	Other Objectives.....	1-2
1.3	Visibility of Objects	1-2
1.4	Types of Lighting System Configurations.....	1-3
1.4.1	Continuous Freeway Lighting.....	1-3
1.4.2	Partial Interchange Lighting	1-3
1.4.3	Complete Interchange Lighting.....	1-3
1.4.4	Underpass Lighting	1-3
1.4.5	Other Streets and Highways Lighting	1-4
1.4.6	Bridge Lighting	1-4
1.4.7	Roadways with Median Barriers Lighting.....	1-4
1.4.8	Intersection Lighting.....	1-4
1.4.9	Roundabout Lighting	1-5
1.5	Lighting Warrants	1-7
1.5.1	Continuous Freeway Lighting.....	1-7
1.5.2	Complete Interchange Lighting.....	1-7
1.5.3	Partial Interchange Lighting	1-8
1.5.4	Non-Freeway Lighting	1-8
1.6	Minnesota’s Energy Law	1-9
2.	LIGHTING EQUIPMENT	2-1
2.1	Luminaires.....	2-1
2.1.1	Optical System	2-3
2.1.2	Electrical System.....	2-7
2.1.3	Mechanical System.....	2-8
2.2	Luminaire Support System	2-8
2.2.1	Mast Arms.....	2-8
2.2.2	Poles.....	2-8
2.2.3	Light Bases/Foundations.....	2-12
2.2.4	Mn/DOT Standard Luminaire and Support System Types.....	2-13
2.3	Selection of Lighting Equipment	2-14
2.3.1	Cobra Head Lighting Equipment.....	2-14
2.3.2	Vertical Mount Lighting Equipment.....	2-15
2.3.3	High Mast Lighting Equipment.....	2-15
2.3.4	Shoebox Lighting Equipment Options	2-16
2.4	Service Cabinets.....	2-16
2.4.1	Service Cabinet, Secondary Type L2	2-16
2.4.2	Service Cabinet, Secondary Type L1	2-16
2.4.3	Service Cabinet, Secondary Type A.....	2-17
2.4.4	Service Cabinet, Secondary Type B.....	2-18
2.4.5	Service Cabinet, Type RLF	2-18

3.	PHOTOMETRY.....	3-1
3.1	Photometrics.....	3-1
3.1.1	Coefficient of utilization	3-1
3.1.2	Isofootcandle chart	3-3
3.1.3	Vertical Light Distributions.....	3-4
3.1.4	Lateral Light Distributions	3-4
3.2	Lamp and Luminaire Depreciation Factors.....	3-5
4.	LIGHTING DESIGN	4-1
4.1	Mn/DOT Roadway Lighting Design Process	4-1
4.1.1	Design Step 1. Assess the Facility to be Lit and Determine the Minimum Footcandle Levels	4-1
4.1.2	Design Step 2. Selection of Luminaire and Pole Equipment.....	4-7
4.1.3	Design Step 3. Determine Luminaire Spacing	4-7
4.1.4	Design Step 4. Check Design Accuracy	4-11
4.1.5	Design Step 5. Determine the Source of Power.....	4-14
4.1.6	Design Step 6. Lay out the Lighting System.....	4-16
4.1.7	Design Step 7. Lay Out Wiring and Conduit System	4-17
4.1.8	Design Step 8. Calculate Voltage Drops.....	4-19
4.1.9	Design Step 9. Iterate Steps 7 and 8	4-24
4.1.10	Design Step 10. Complete Wiring Diagram, Service Cabinet, and Number Poles	4-24
4.1.11	Design Step 11. Determine Salvage and Removal Items	4-24
4.1.12	Design Step 12. Determine Temporary Lighting Needs.....	4-24
4.1.13	Design Step 13. Determine Quantities	4-24
4.1.14	Design Step 14. Finish Plan Set Layout	4-25
4.2	Sample Letters	4-36
4.3	Lighting Design Computer Programs	4-39
4.4	Temporary Lighting.....	4-39
5.	SPECIFICATIONS AND AGREEMENTS	5-1
5.1	Current Specifications Book	5-1
5.2	Special Provisions	5-1
5.3	Agreements (Cost and/or Maintenance).....	5-2
5.4	Cost Sharing Policy.....	5-2
6.	SAMPLE LIGHTING PLANS (11" X 17").....	6-1
7.	SAMPLE LIGHTING PLANS (8.5" X 11").....	7-2
APPENDIX A	- GLOSSARY OF LIGHTING TERMS.....	A-1
APPENDIX B	- LIST OF REFERENCES.....	B-1
APPENDIX C	- SAFETY BENEFITS OF ROADWAY LIGHTING REPORT	C-1
APPENDIX D	- STANDARD PLATES AND DETAILS.....	D-1
APPENDIX E	- SAMPLE SPECIAL PROVISIONS.....	E-1
APPENDIX F	- MISCELLANEOUS INFORMATION	F-1
APPENDIX G	- INDEX	G-2

ROADWAY LIGHTING DESIGN COURSE INTRODUCTION

Background

This Roadway Lighting Design course has been developed to provide training on the design of roadway lighting systems. Example problems will help develop the concepts needed to understand and design a lighting system. Three lighting plan sets are provided as a reference.

The course manual has been divided into seven chapters as follows:

- Chapter 1 presents Lighting Basics.
- Chapter 2 covers Lighting Equipment.
- Chapter 3 covers the basics of Photometry.
- Chapter 4 addresses the Mn/DOT Lighting Design methods and covers the Mn/DOT Lighting Plan Preparation steps.
- Chapter 5 outlines Specifications and Agreements pertaining to roadway lighting plans.
- Chapter 6 contains two sample Mn/DOT Lighting Plans.
- Chapter 7 is the Appendix with Glossary of Terms, References, a report titled Safety Benefits of Roadway Lighting, Standard Plates, a sample Special Provision, miscellaneous information, and an index.

The purpose of this course is to present the fundamental concepts and standard practices related to the design of lighting systems for **Mn/DOT**.

This course is structured to parallel the progression of decisions, activities and functions related to the design of lighting systems.

Course Schedule

Day 1

Time	Topic	Chapter	Comments
7:30	Registration	-	-
8:00	Introduction	-	-
8:15	Lighting Basics	1	terms, purpose, visibility, configurations, warrants
9:45	Break	-	-
10:00	Lighting Equipment	2	luminaires, luminaire support system, selection of lighting equipment, service cabinets
12:00	Lunch	-	Equipment Presentation
1:00	Photometry	3	coefficient of utilization, isofootcandle charts, depreciation factors
2:15	Break	-	-
2:30	Lighting Design	4	Lighting design process
4:00	Adjourn*	-	-

Day 2

Time	Topic	Chapter	Comments
8:00	Introduction & Recap	-	-
8:15	Lighting Design	4	continued
9:45	Break	-	-
10:00	Lighting Design	4	continued
12:00	Lunch	-	-
1:00	Specifications and Agreements	5	<i>Mn/DOT Presentation</i> design standards, special provisions
2:15	Break	-	-
2:30	Sample Lighting Plans	6	-
3:45	Course Wrap-up and Questions	-	-
4:00	Adjourn*	-	-

Instructor Information

Sue Zarlino, P, PTOE will serve as a technical resource for the development and course instruction. Sue is the Signal Lighting Engineer in the office of Traffic, Security and Technology.

Phil Stohr will serve as a technical resource for the development and course instruction. Phil is a Lighting Designer in the office of Traffic, Security and Technology.

John Albeck, PE, PTOE will serve as instructor for the course. John is a transportation engineer with Albeck Gerken, Inc.

Disclaimer

This Manual is disseminated under the sponsorship of the Minnesota Department of Transportation (Mn/DOT), Office of Traffic, Security and Technology. Mn/DOT and Albeck Gerken, Inc. assume no liability for its contents or use thereof.

Mn/DOT does not endorse software, products or manufacturers. Trademarks of manufacturers’ names may appear herein only because they are considered essential to the object of this manual.

Mere possession of this manual does not qualify an individual to design roadway lighting systems. Designing roadway lighting systems is an integrated process that requires a solid understanding of lighting fundamentals.

The most current version of this manual in Adobe PDF format is on the Office of Traffic, Security and Operation’s web site. You can find this at, <http://www.dot.state.mn.us/trafficeng/>.

1. LIGHTING BASICS

Good visibility under day or night conditions is one of the fundamental requirements enabling motorists to move on roadways in a safe manner. Properly designed and maintained street lighting will provide comfort and safety during nighttime conditions for both vehicular and pedestrian traffic. This chapter will cover:

- Definitions of frequently used lighting terms
- The purpose of roadway lighting
- Visibility of objects
- Types of lighting system configurations
- Lighting warrants
- Minnesota's Energy Law

The purpose of roadway lighting is to attain a level of visibility which enables the motorist and pedestrian to see quickly, distinctly, and with certainty all significant detail, notably the alignment of the road (its direction and its surroundings) and any obstacles on or about to enter the roadway. Nearly all aspects of

1.1 Definition of Terms

General Lighting terms are defined as follows:

Light: Visually evaluated radiant energy.

Visibility: The quality or state of being perceivable by the eye.

Luminaire: A complete unit consisting of a lamp or lamps together with the parts designed to distribute the light, to position and protect the lamps and to connect the lamps to the power supply.

Properties of Light, Symbols, Units, and Relationships:

Luminous Intensity: The force of luminous flux in a specified direction, measured in candela (cd).

Luminous Flux: Time rate flow of light, measured in lumens (lm). One lumen is the amount of light which falls on an area of one square foot, every point of which is one foot from the source of one candela. A light source of one candela emits a total of 12.57 lumens.

Luminous Exitance: Total amount of luminous flux reflected or transmitted by a source or surface (direction independent), measured in lm/ft^2 (lm/m^2).

Illuminance: The density of luminous flux incident on a surface, measured in footcandles, fc (or lux, lx). One footcandle is the illumination of a surface one square foot in area on which there is a uniformly distributed luminous flux of one lumen. One footcandle is 10.76 lux.

Luminance (photometric brightness): The quantity of luminous flux emitted, reflected, or transmitted from a surface in a particular direction, measured in cd/ft^2 or cd/m^2 . This is the property of light we can visibly see with our eyes.

Term	Symbol	English Unit	Metric Unit	Relationship
Luminous Intensity	I	candela (cd)		$I = \phi/\omega$, $\omega = A/r^2$
Luminous Flux	ϕ	lumens (lm)		$\phi = I \omega$
Luminous Exitance	M	lm/ft^2	lm/m^2	$M = \phi'/A$
Illuminance	E	$\text{fc} = \text{lm}/\text{ft}^2$	$\text{lx} = \text{lm}/\text{m}^2$	$E = \phi/A$ $1 \text{ fc} = 10.76 \text{ lx}$
Luminance	L	cd/ft^2	cd/m^2	$L = I/A \cos \theta$

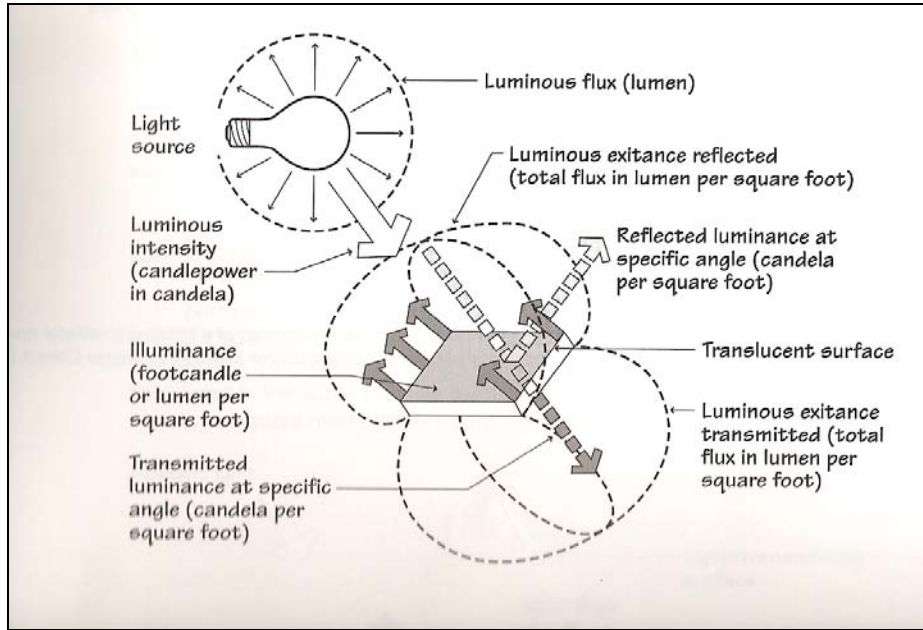

Illustration of the Properties of Light

1.2 Purpose of Roadway Lighting

1.2.1 Traffic Engineering Objectives

The following are traffic engineering objectives of roadway lighting:

Promotion of safety at night by providing quick, accurate, and comfortable visibility for drivers and pedestrians.

Improvement of traffic flow at night by providing light, beyond that provided by vehicle lights, which aids drivers in orienting themselves, delineating roadway geometries and obstructions, and judging opportunities for overtaking.

Illumination in long underpasses and tunnels during the day to permit drivers entering such structures from the daylight to have adequate visibility for safe vehicle operation.

1.2.2 Other Objectives

The following are other objectives of roadway lighting:

- Reduction of street crimes after dark. From the traffic engineer's perspective, this ancillary benefit could attract non-traditional funding sources.
- Enhancement of commercial (especially retail sales) properties by attracting evening shoppers, audiences, and other users.

Not all of these objectives are necessarily achieved by good lighting alone.

1.3 Visibility of Objects

Visibility is the state of being perceived by the eye. The purpose of roadway lighting is to attain a level of visibility which enables the motorist and pedestrian to see quickly, distinctly, and with certainty all significant roadway details, such as the alignment of the road (its direction and its surroundings) and any obstacles on

or about to enter the roadway. Nearly all aspects of traffic safety involve visibility. Some factors that directly influence visibility are:

1. Brightness of an object on or near the roadway
2. General brightness of roadway background – ambient light
3. Size of object and identifying detail
4. Contrast between an object and its surroundings
5. Contrast between pavement and its surroundings as seen by the observer
6. Time available for seeing the object
7. Glare
 - Discomfort glare: Ocular discomfort that doesn't affect visual performance.
 - Disability glare: Reducing ability to see or spot an object.
 - Blinding glare: Glare so intense that for an appreciable length of time no object can be seen.
8. Driver vision
9. Condition of windshield

Good visibility on roadways at night results from lighting (both fixed and vehicular), which provides adequate pavement illumination with good uniformity and appropriate illumination of adjacent areas, together with reasonable freedom from glare.

1.4 Types of Lighting System Configurations

Various lighting system configurations are defined and discussed in this section.

1.4.1 Continuous Freeway Lighting

Continuous freeway lighting places continuous lighting that encompasses the roadway and area immediately adjacent to the roadway over a substantial distance along the freeway.

1.4.2 Partial Interchange Lighting

Partial freeway lighting is the illumination of only the parts of the interchange that are most critical to the night driver, which are the merge-diverge areas of the ramp connections, intersections, and other critical roadway features.

1.4.3 Complete Interchange Lighting

Complete interchange lighting is applying lighting to the interchange to achieve illumination of all roadways in the interchange.

1.4.4 Underpass Lighting

Where AASHTO's *Roadway Lighting Design Guide* indicates that underpass lighting is desirable, the lights are mounted on the abutment of the bridge or on a pier for each direction of travel on the roadway. If such mounting would lower light levels to a non-acceptable level then the luminaire is typically mounted on the bottom of the diaphragm.

Generally, for continuously lit freeways, underpass lighting should be installed for structures greater than 50 feet in length. For underpasses that are longer than 200 feet, underpasses should be lit all day.

1.4.5 Other Streets and Highways Lighting

Lighting levels and uniformity ratios for streets and highways other than freeways are contained in Chapter 4 of this manual. The design for these roadways is often matched to existing lighting in a city rather than to freeway design standards.

1.4.6 Bridge Lighting

The roadway on a bridge is normally treated the same as other parts of the roadway. If there is no lighting on the adjacent roadway, there is normally no need for lighting on the bridge. An exception is a very long bridge, which may be lit even though the roadway is not lit at other locations.

Where lights are to be installed on a bridge, the desirable locations for the lighting units are at abutments and at pier locations, or at a distance from an abutment or pier not to exceed 25 percent of the length of the span. This placement of the lighting units reduces the effects of vibration. The light poles should utilize davit type mast arms and shorter mast arm lengths so that there are no joints to be weakened by vibration.

If a local governmental agency requests ornamental lighting on a new Mn/DOT bridge or bridge replacement project, Mn/DOT will participate in funding in accordance with current cost participation guidelines.

The installation of navigation and air obstruction lights are an integral part of the bridge design. The Office of Bridges and Structures may ask the lighting designer to coordinate electrical service points for the roadway lighting and navigational/air obstruction lighting.

1.4.7 Roadways with Median Barriers Lighting

The median barrier twin mast arm lighting units have certain advantages such as providing the same number of luminaires with fewer poles, utilizing back light from luminaires, and are less likely to be knocked down. The disadvantages of median lighting are that traffic control is required when working on median lights and the potential danger to employees working on the median lights. In high volume urban areas, it is very difficult to maintain barrier lighting and, if possible, luminaires should be placed on the outside edge of the roadway (side-mounted). Additionally, median barrier mounted lights should not be used in high volume areas without a 10-foot inside shoulder. If used, median barrier mounted luminaires typically use double 6-foot davit-type mast arms.

1.4.8 Intersection Lighting

Lighting at intersections is usually justified and will alert the driver to an approaching intersection. Notes regarding intersection lighting are as follows:

- Luminaires should be placed on or near prominent conflict points.
- Lighting should be provided at all signalized and flashing beacon intersections.
- A signal pole shaft extension with a luminaire mast arm should be utilized whenever possible to avoid adding more poles at the intersection.
- Street lights on traffic signal poles should be fed from the traffic signal service point.
- The level of illumination of a signalized intersection is dictated by the area classification (commercial, residential) of the roadway.
- Additional light poles may be necessary when the intersection has channelization or complex turning lanes.

- Suggested levels of illumination and average horizontal footcandles for roadway lighting are given in Chapter 4.
- The level of illumination at an intersection should be 1.0 greater than that between intersections where there is continuous lighting.
- Where the level of illumination is low between intersections, such as 0.6 footcandles, the light intensity at the intersection should be doubled as a rule.

1.4.9 Roundabout Lighting

Chapter 7.3 of the FHWA document *Roundabouts: An Informational Guide* (see handout included after page 1-6) contains information on the illumination of roundabouts. The document states that the need for illumination varies somewhat based on the location in which the roundabout is located (urban, suburban, or rural conditions). Generally, roundabouts should always be lit. The following features are recommended:

- Good illumination should be provided on the approach nose of the splitter islands, at all conflict areas where traffic is entering the circulation stream, and at all places where the traffic streams separate to exit the roundabout.
- It is preferable to light the roundabout from the outside in towards the center. This improves the visibility of the central island and the visibility of circulating vehicles to vehicles approaching the roundabout.

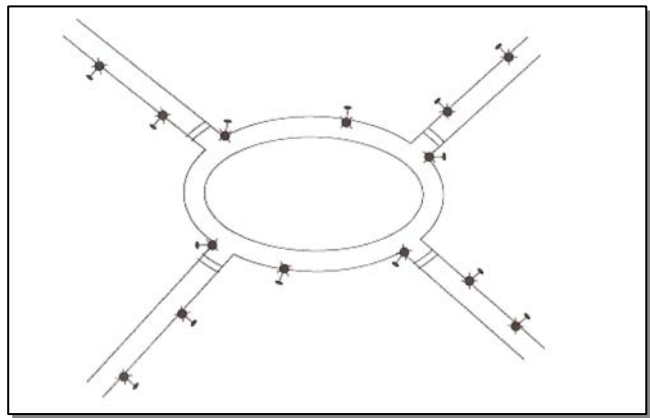

Refer to the document for more detailed information regarding roundabout lighting. Chapter 7 of the AASHTO *Roadway Lighting Design Guide* also has some information on roundabout lighting.

Mn/DOT recommends that the illumination levels of conventional intersections should be approximately 1 footcandle greater than that between intersections where there is continuous lighting. Where the level of illumination is low between intersections the light intensity at the intersection should be doubled as a rule.

The lighting should be extended a minimum of 400 feet along each road connecting to the roundabout. Light levels on these should meet the values shown in Table 3-5 (of the *Roadway Lighting Design Guide*) or as otherwise required.

Providing good pedestrian recognition is an important issue at roundabouts. Crosswalks at roundabouts should typically be lit with the pedestrians in positive contrast. Light poles placed 1- to 30 feet before the crosswalk is recommended for this purpose. Roundabouts should be lit from the outer edge of the roadway to aid in providing this positive contrast to pedestrians. Other typical light pole recommended locations are also shown in the figure below.

The information following this sheet is a DRAFT Mn/DOT document on roundabout illumination. In addition, a handout from Section 7.3 of the FHWA document *Roundabouts: An Informational Guide* is included. You can obtain the FHWA document by visiting:

www.tfrc.gov/safety/00068.htm

It is recommended that you review all original reference material to check for updates.

Draft 3/21/06

Illumination

A driver must be able to perceive the general layout and operation of an intersection in time to make appropriate maneuvers. To accomplish this, adequate lighting should be provided at all roundabouts. Additional illumination guidance is in the Mn/DOT Roadway Lighting Design Manual.

Need for Illumination

The need for illumination may vary based on the location of the roundabout.

Urban Conditions

Illumination should be provided in an urban condition since most or all of the approaches of an urban roundabout are typically illuminated and to improve the visibility of pedestrians and bicyclists. If the designer's goal is to emphasize the role of this facility as a transition speed zone, illumination becomes an important asset.

Suburban Conditions

Illumination is recommended and needs to be considered for all suburban roundabouts.

Illumination should be installed for safety reasons when any of the following conditions are present.

- One or more approaches are illuminated.
- Competing non-roadway illumination in the vicinity can distract the driver's attention (i.e. highly illuminated parking lots, car lots or filling stations).
- Heavy nighttime traffic is anticipated.
- Pedestrian and/or bicycle traffic is anticipated (approaches have sidewalks).

Provide continuity of illumination between illuminated areas and the roundabout itself. An unlit roundabout with one or more illuminated approaches is dangerous. This is because a driver approaching on an unlit approach will be attracted to the illuminated area(s) and may not see the roundabout.

Rural Conditions

Illumination is recommended for rural roundabouts but it is not mandatory. Illumination can be costly if there is no power supply near the intersection. If lighting is not provided, then make sure the intersection is well signed and marked so that it can be correctly perceived by day and night. Use of reflective pavement marking and retroreflective signs should be used when lighting cannot be installed in a cost effective manner.

It must be remembered that in rural situations the operating speed of the traffic approaching and negotiating the roundabout is often higher than that in an urban or suburban setting. The roundabout will come upon the driver quickly. Drivers may also be more surprised to see a roundabout in a rural setting. Thus, the ability of the motorist to recognize and navigate the roundabout at higher speeds will need to be established in order to determine if illumination will in itself provide an additional safety aspect.

Where illumination is provided, illuminate any raised channelization or curbing. In general, extend lighting a minimum of 400 feet along each road connecting to the roundabout. This helps drivers adjust their vision back into the dark environment of the exiting roadway, which takes approximately 1 to 2 seconds. In addition, avoid short-distance dark areas between two consecutive illuminated areas.

Standards and Recommended Practices

Consider the following standards and recommended practices when completing the lighting plan:

AASHTO, *Roadway Lighting Design Guide*. This is the basic guide for highway lighting. It includes information on warranting conditions and design criteria.

ANSI / IESNA RP-8-00: *American National Standard Practice for Roadway Lighting*. This Recommended Practice, published by the Illuminating Engineering Society of North America provides standards for average maintained illuminance, and small target visibility, as well as uniformity of lighting.

Mn/DOT recommends that the illumination levels of conventional intersections should be approximately 1 footcandle greater than that between intersections where there is continuous lighting. Where the level of illumination is low between intersections the light intensity at the intersection should be doubled as a rule.

The basic principle behind the lighting of roundabouts in urban and suburban areas is that the amount of light on the intersection should be proportional to the light provided on the intersecting streets and equal to the sum of the values used for each separate street. Using Table 1 to determine the design level of illumination will give you the correct light level based on IES Standards.

Designing the roundabout to have the illumination levels given in Table 1 will result in illumination levels at the roundabout ranging from 8 lux (0.7 fc) for roundabouts at the intersection of two local streets with low pedestrian traffic volume (two intersecting local streets each having an illumination level of 4 lux, the resulting sum is 8 lux), to 34 lux (3.2 fc) for roundabouts at the intersection of two major streets with high pedestrian traffic volume.

Table 1. Illuminance Levels at Roundabouts and Other Intersections.

Recommended Illuminance for Intersections				
Roadway Classification (Street A/Street B)	Average Maintained Illuminance at Pavement ¹			Uniformity Ratio (E_{avg}/E_{min}) ²
	Pedestrian/Area Classification			
	High lux (fc)	Medium lux (fc)	Low lux (fc)	
Major/Major	34.0 (3.2)	26.0 (2.4)	18.0 (1.7)	3.0
Major/Collector	29.0 (2.7)	22.0 (2.1)	15.0 (1.4)	3.0
Major/Local	26.0 (2.4)	20.0 (1.9)	13.0 (1.2)	3.0
Collector/Collector	24.0 (2.2)	18.0 (1.7)	12.0 (1.1)	4.0
Collector/Local	21.0 (2.0)	16.0 (1.5)	10.0 (0.9)	4.0
Local/Local	18.0 (1.7)	14.0 (1.3)	8.0 (0.7)	6.0

¹ fc = foot candles (conversion factor from lux to foot candles is 10.67.)

² E_{avg} = Average Horizontal Illuminance, E_{min} = Minimum Horizontal Illuminance

Source: ANSI / IESNA RP-8-00 Table 9

Roadway Classification:

Major: That part of the roadway system that serves as the principal network for through-traffic flow. The routes connect areas of principal traffic generation and important rural

roadways leaving the city. Also often known as “arterials,” thoroughfares,” or “preferentials.”

Collector: Roadways servicing traffic between major and local streets. These are streets used mainly for traffic movements within residential, commercial, and industrial areas. They do not handle long, through trips.

Local: Local streets are used primarily for direct access to residential, commercial, industrial, or other abutting property.

Pedestrian Classification:

High: Areas with significant numbers of pedestrians expected to be on the sidewalks or crossing the streets during darkness. Examples are downtown retail areas, near theaters, concert halls, stadiums and transit terminals.

Medium: Areas where lesser numbers of pedestrians use the streets at night. Typical are downtown office areas blocks with libraries, apartments, neighborhood shopping, industrial, older city areas, and streets with transit lines.

Low: Areas with very low volumes of night pedestrian usage. These can occur in any of the cited roadway classifications but may be typified by suburban single-family streets, very low-density residential developments and rural or semi-rural areas.

NOTE: Values in Table 1 assume typical asphalt roadway surface. Mn/DOT will not use different pavement classifications to determine illumination levels.

General Recommendations

The primary goal of illumination is to avoid surprising drivers by enabling them to see the geometric features of the roundabout and its approach. Lighting also facilitates mutual visibility among the various users. To achieve this, the following features are recommended:

- Provide good illumination on the approach nose of the splitter islands, at all conflict areas where traffic is entering the circulating stream, and at all places where the traffic streams separate to exit the roundabout.
- Light the roundabout from the outside in towards the center to improve the visibility of the central island and the visibility of circulating vehicles to vehicles approaching the roundabout. Avoid lighting from the central island outward since vehicles become shadows against the light, and thus, less visible.
- Special consideration should be given to lighting pedestrian crossing and bicycle merging areas.

Clear Zone Requirements

The position of lighting poles relative to the curbs at a roundabout is governed in part by the speed environment in which the roundabout is located and the potential speeds of errant vehicles that can be reasonably expected. Refer to the *AASHTO Roadside Design Guide* for information on roadside safety. Avoid placing lighting supports and other poles or hazards within the splitter islands or on the right-hand perimeter just downstream of an exit point. Avoid placing light poles in the central island when the island diameter is less than 20M (65 ft).

REFERENCES

Roundabouts: An Informational Guide – U.S. Department of Transportation, Federal Highway Administration, June 2000

American National Standard Practice for Roadway Lighting – ANSI/IESNA RP-8-00, 6/27/00

Traffic Guidelines Manual, 11-11-1 – State of Wisconsin Department of Transportation, June 2004

7.3 Illumination

For a roundabout to operate satisfactorily, a driver must be able to enter the roundabout, move through the circulating traffic, and separate from the circulating stream in a safe and efficient manner. To accomplish this, a driver must be able to perceive the general layout and operation of the intersection in time to make the appropriate maneuvers. Adequate lighting should therefore be provided at all roundabouts. Exhibit 7-22 shows an example of an illuminated roundabout at night.

Exhibit 7-22. Illumination of a roundabout.



Loveland, CO

7.3.1 Need for illumination

The need for illumination varies somewhat based on the location in which the roundabout is located.

7.3.1.1 Urban conditions

In urban settings, illumination should be provided for the following reasons:

- Most if not all approaches are typically illuminated.
- Illumination is necessary to improve the visibility of pedestrians and bicyclists.

7.3.1.2 Suburban conditions

For roundabouts in suburban settings, illumination is recommended. For safety reasons, illumination is necessary when:

- One or more approaches are illuminated.
- An illuminated area in the vicinity can distract the driver's view.
- Heavy nighttime traffic is anticipated.



Continuity of illumination must be provided between illuminated areas and the roundabout itself (5). An unlit roundabout with one or more illuminated approaches is dangerous. This is because a driver approaching on an unlit approach will be attracted to the illuminated area(s) and may not see the roundabout.

7.3.1.3 Rural conditions

For rural roundabouts, illumination is recommended but not mandatory. If there is no power supply in the vicinity of the intersection, the provision of illumination can be costly. When lighting is not provided, the intersection should be well signed and marked so that it can be correctly perceived by day and night. The use of reflective pavement markers and retroreflective signs (including chevrons supplementing the ONE-WAY signs) should be used when lighting cannot be installed in a cost-effective manner.

Where illumination can be provided, any raised channelization or curbing should be illuminated. In general, a gradual illumination transition zone of approximately 80 m (260 ft) should be provided beyond the final trajectory changes at each exit (5). This helps drivers adapt their vision from the illuminated environment of the roundabout back into the dark environment of the exiting roadway, which takes approximately 1 to 2 seconds. In addition, no short-distance dark areas should be allowed between two consecutive illuminated areas (5).

7.3.2 Standards and recommended practices

The following standards and recommended practices should be consulted in completing the lighting plan:

- AASHTO, *An Information Guide for Roadway Lighting* (6). This is the basic guide for highway lighting. It includes information on warranting conditions and design criteria.
- AASHTO, *Standard Specifications for Structural Supports for Highway Signs, Luminaires and Traffic Signals* (7). This specification contains the strength requirements of the poles and bracket arms for various wind loads, as well as the frangibility requirements. All luminaire supports, poles, and bracket arms must comply with these specifications.
- IES RP-8: *The American National Standard Practice for Roadway Lighting* (8). This Recommended Practice, published by the Illuminating Engineering Society, provides standards for average-maintained illuminance, luminance, and small target visibility, as well as uniformity of lighting. Recommended illumination levels for streets with various classifications and in various areas are given in Exhibit 7-23.



Exhibit 7-23. Recommended street illumination levels.

Street Classification	Area Classification	Average Maintained Illuminance Values	Illuminance Uniformity Ratio (Average to Minimum)
Arterial	Commercial	17 lx (1.7 fc)	3 to 1
	Intermediate	13 lx (1.3 fc)	
	Residential	9 lx (0.9 fc)	
Collector	Commercial	12 lx (1.2 fc)	4 to 1
	Intermediate	9 lx (0.9 fc)	
	Residential	6 lx (0.6 fc)	
Local	Commercial	9 lx (0.9 fc)	6 to 1
	Intermediate	7 lx (0.7 fc)	
	Residential	4 lx (0.4 fc)	

Definitions:

- Commercial** A business area of a municipality where ordinarily there are many pedestrians during night hours. This definition applies to densely developed business areas outside, as well as within, the central part of a municipality. The area contains land use which attracts a relatively heavy volume of nighttime vehicular and/or pedestrian traffic on a frequent basis.
- Intermediate** Those areas of a municipality often with moderately heavy nighttime pedestrian activity such as in blocks having libraries, community recreation centers, large apartment buildings, industrial buildings, or neighborhood retail stores.
- Residential** A residential development, or a mixture of residential and small commercial establishments, with few pedestrians at night.

Note: Values in table assume typical asphalt roadway surface (pavement classification R2 or R3). Consult the IES document for other pavement surfaces.

Source: Illuminating Engineering Society RP-8 (8)

7.3.3 General recommendations

The primary goal of illumination is to ensure perception of the approach and mutual visibility among the various categories of users. To achieve this, the following features are recommended:

- The overall illumination of the roundabout should be approximately equal to the sum of the illumination levels of the intersecting roadways. If the approaching roadways have been designed to the illumination levels given in Exhibit 7-23, this may result in illumination levels at the roundabout ranging from 9 lx (0.8 fc) for roundabouts at the intersection of local streets in residential areas to 36 lx (3.4 fc) for roundabouts at the intersection of arterials in commercial areas. Local illumination standards should also be considered when establishing the illumination at the roundabout to ensure that the lighting is consistent.
- Good illumination should be provided on the approach nose of the splitter islands, at all conflict areas where traffic is entering the circulating stream, and at all places where the traffic streams separate to exit the roundabout.
- It is preferable to light the roundabout from the outside in towards the center. This improves the visibility of the central island and the visibility of circulating vehicles to vehicles approaching to the roundabout. Ground-level lighting within the central island that shines upwards towards objects in the central island can improve their visibility.

Lighting from the central island causes vehicles to be backlit and thus less visible.

- Special consideration should be given to lighting pedestrian crossing and bicycle merging areas.

7.3.4 Clear zone requirements

As discussed in Chapter 5, the proportion of single-vehicle crashes at roundabouts is high compared to other intersection types. This is because roundabouts consist of a number of relatively small-radii horizontal curves for each traveled path through the roundabout. Drivers travel on these curves with quite high values of side friction, particularly at roundabouts in higher speed areas. Single-vehicle crashes, which predominantly involve out-of-control vehicles, increase with an increased amount of side friction.

Because of the relatively high number of out-of-control vehicles, it is desirable to have adequate amounts of clear zone where there are no roadside hazards on each side of the roadway. Lighting supports and other poles should not be placed within small splitter islands or on the right-hand perimeter just downstream of an exit point. Lighting poles should be avoided in central islands when the island diameter is less than 20 m (65 ft).

The reader should refer to the AASHTO *Roadside Design Guide* for a more detailed discussion of clear zone requirements (9).

7.4 Work Zone Traffic Control

During the construction of a roundabout it is essential that the intended travel path be clearly identified. This may be accomplished through pavement markings, signing, delineation, channelizing devices, and guidance from police and/or construction personnel, depending on the size and complexity of the roundabout. Care should be taken to minimize the channelizing devices so that the motorist, bicyclist, and pedestrian has a clear indication of the required travel path. Each installation should be evaluated separately, as a definitive guideline for the installation of roundabouts is beyond the scope of this guide. Refer to Part 6 of the MUTCD for requirements regarding work zone traffic control.

7.4.1 Pavement markings

The pavement markings used in work zones should be the same layout and dimension as those used for the final installation. Because of the confusion of a work area and the change in traffic patterns, additional pavement markings may be used to clearly show the intended direction of travel. In some cases when pavement markings cannot be placed, channelizing devices should be used to establish the travel path.

7.4.2 Signing

The signing in work zones should consist of all necessary signing for the efficient movement of traffic through the work area, preconstruction signing advising the pub

This section not covered in the Roadway Lighting Design manual

Construction signing for a roundabout should follow the MUTCD standard.

1.5 Lighting Warrants

The primary purpose of warrants is to assist administrators and designers in evaluating locations for lighting needs and selecting locations for installing lighting. Warrants give conditions that should be satisfied to justify the installation of lighting. Meeting these warrants does not obligate the state or other agencies to provide lighting or participate in its cost. Conversely, local information in addition to that reflected by the warrants, such as roadway geometry, ambient lighting, sight distance, signing, crash rates, or frequent occurrences of fog, ice, or snow, may influence the decision to install lighting. Warrants for freeway lighting are contained in AASHTO's *Roadway Lighting Design Guide*. Modifications and additions to these warrants are indicated below.

1.5.1 Continuous Freeway Lighting

Case CFL-1 - Continuous freeway lighting is considered to be warranted on those sections in and near cities where the current ADT is 30,000 or more.

Case CFL-2 - Continuous freeway lighting is considered to be warranted on those sections where three or more successive interchanges are located with an average spacing of 1.5 miles or less, and adjacent areas outside the right-of-way are substantially urban in character.

Case CFL-3 - Continuous freeway lighting is considered to be warranted where for a length of 2 miles or more, the freeway passes through a substantially developed suburban or urban area in which one or more of the following conditions exist:

- a. local traffic operates on a complete street grid having some form of street lighting, parts of which are visible from the freeway;
- b. the freeway passes through a series of developments such as residential, commercial, industrial and civic areas, colleges, parks, terminals, etc., which includes roads, streets and parking areas, yards, etc., that are lighted;
- c. separate cross streets, both with and without connecting ramps, occur with an average spacing of 0.5 miles or less, some of which are lighted as part of the local street system; and
- d. the freeway cross section elements, such as median and borders, are substantially reduced in width below desirable sections used in relatively open country.

Case CFL-4 - Continuous freeway lighting is considered to be warranted on those sections where the ratio of night to day crash rate is at least 2.0 times the statewide average for all unlighted similar sections, and a study indicates that lighting may be expected to result in a significant reduction in the night crash rate.

Continuous freeway lighting should be considered for all median barriers on roadway facilities in urban areas. In rural areas each location must be individually evaluated as to its need for illumination.

1.5.2 Complete Interchange Lighting

Case CIL-1 – Complete Interchange Lighting is considered to be warranted where the total current ADT ramp traffic entering and leaving the freeway within the interchange areas exceeds 10,000 for urban conditions, 8,000 for suburban conditions, or 5,000 for rural conditions.

Case CIL-2 - Complete Interchange Lighting is considered to be warranted where the current ADT on the crossroad exceeds 10,000 for urban conditions, 8,000 for suburban conditions, or 5,000 for rural conditions.

Case CIL-3 - Complete Interchange Lighting is considered to be warranted where existing substantial commercial or industrial development that is lighted during hours of darkness is located in the immediate

vicinity of the interchange, or where the crossroad approach legs are lighted for 0.5 miles or more on each side of the interchange.

Case CIL-4 - Complete Interchange Lighting is considered to be warranted where the ratio of night to day crash rate within the interchange area is at least 1.5 times the statewide average for all unlighted similar sections, and a study indicates that lighting may be expected to result in a significant reduction in the night crash rate.

1.5.3 Partial Interchange Lighting

Case PIL-1 - Partial interchange lighting is considered to be warranted where the total current ADT ramp traffic entering and leaving the freeway within the interchange areas exceeds 5,000 for urban conditions, 3,000 for suburban conditions, or 1,000 for rural conditions.

Case PIL-2 - Partial interchange lighting is considered to be warranted where the current ADT on the freeway through traffic lanes exceeds 25,000 for urban conditions, 20,000 for suburban conditions, or 10,000 for rural conditions.

Case PIL-3 - Partial interchange lighting is considered to be warranted where the ratio of night to day crash rate within the interchange area is at least 1.25 times the statewide average for all unlighted similar sections, and a study indicates that lighting may be expected to result in a significant reduction in the night crash rate.

1.5.4 Non-Freeway Lighting

The AASHTO *Roadway Lighting Design Guide* gives no specific warrants for continuous lighting of roadways other than freeways (roads with fully controlled access, no at-grade intersections), but does suggest some general criteria that may apply when considering the installation of lighting.

Lighting of at-grade intersections is warranted if the geometric conditions mentioned in the AASHTO *Roadway Lighting Design Guide* exist or if one or more of the following conditions exists as found in the *Minnesota Traffic Engineering Manual*:

1. Volume - The traffic signal warrant volumes for the minimum vehicular volume warrant, the interruption of continuous traffic warrant, or the minimum pedestrian volume warrant are satisfied for any single hour during conditions other than daylight, excluding the time period between 6:00 a.m. and 6:00 p.m.
2. Crashes - There are three or more crashes per year occurring during conditions other than daylight. Currently, thresholds for ratios of night to day crash rates are being developed for non-freeway facilities. Check the Traffic Engineering Manual for updates.
3. Intersecting Roadway - The intersecting roadway is lighted.
4. Ambient Light - Illumination in areas adjacent to the intersection adversely affects the drivers' vision.
5. Channelization - The intersection is channelized and the 85th percentile approach speed exceeds 40 miles per hour. A continuous median is not considered as channelization for the purpose of this warrant.
6. School Crossing - Scheduled events occurring at least once per week during the school year make it necessary for 100 or more pedestrians to cross at the school crossing during any single hour in conditions other than daylight, or a traffic engineering study indicates a need for lighting.
7. Signalization - The intersection is signalized.
8. Flashing Beacons - The intersection has a flashing beacon.

Warrants covering lighting for tunnels, underpasses, rest areas, and signs are contained in the AASHTO *Roadway Lighting Design Guide*.

The AASHTO *Roadway Lighting Design Guide* also indicates the following regarding rural highways:

“Rural Highways. *Lighting of spot locations in rural areas should be considered whenever the driver is required to pass through a section of road with complex geometry or raised channelization. The lighting design treatment is typically similar to that for freeway ramp terminals.”*

There is also a discussion of Rural Interchanges:

“An unlighted rural interchange often presents unique conditions that require special consideration before conclusions regarding lighting can be reached. Rural interchanges normally have ample space for sign installation. Where the interchange type and detail are typical of most others on the freeway, and a delineator system is included, the diverging and merging areas may be well understood and reasonably discernible without lighting. However, installation of a few lighting units at the point of on- or off-movements and ramp terminals could contribute to driver ease by providing visual indication for the maneuver areas. Many rural interchanges with low traffic volumes do not warrant roadway lighting. However, there are circumstances under which partial interchange lighting is appropriate and still other conditions where complete interchange lighting is the preferred treatment.”

1.6 Minnesota’s Energy Law

The following paragraph is the new wording for the existing Minnesota Statute 216C.19. The wording was modified by 1992 legislation.

Energy Conservation

Subd. 1. After consultation with the commissioner and the commissioner of public safety, the commissioner of transportation shall adopt rules under chapter 14 establishing minimum energy efficiency standards for street, highway and parking lot lighting. The standards must be consistent with overall protection of the public health, safety and welfare. No new highway, street or parking lot lighting may be installed in violation of these rules. Existing lighting equipment, excluding roadway sign lighting, with lamps with initial efficiencies less than 70 lumens per watt must be replaced when worn out with light sources using lamps with initial efficiencies of at least 70 lumens per watt.

Attention to residential activity is crucial when considering lighting systems since some installations have resulted in local citizen complaints due to the amount of lighted area. This is particularly true with high mast lighting but must be considered for any installation. High mast tower lighting may be objectionable near residential neighborhoods because the high luminaire mounting heights, sometimes exceeding 100 feet, can cause glare and excess light to those areas.

Minnesota Statute 216C.19 can be found at the following link:

www.revisor.mn.gov/statutes/.

2. LIGHTING EQUIPMENT

In this chapter, lighting equipment as it relates to roadway lighting design will be introduced. This chapter will cover the following:

- Luminaires
- Luminaire Support System
- Service Cabinets
- Selection of Lighting Equipment

2.1 Luminaires

A luminaire is the complete lighting unit consisting of a lamp together with the parts designed to distribute the light, to position and protect the lamp, and to connect the lamp to the power supply. Luminaire components will be discussed in the following sections and can be grouped in terms of their functions as follows:

- Optical
- Electrical
- Mechanical

Several factors have influenced the choice of the type of luminaire that Mn/DOT currently uses. The luminaires should be a standard type that is maintainable by and approved by the Office of Traffic, Safety, and Technology Central Electrical Services Unit (CESU), and where applicable, the power company. The Mn/DOT approved product list for luminaires can be found at:

www.dot.state.mn.us/products/lighting/luminaires.html.

Luminaires for roadway lighting should normally be the shallow glass "cobra head" style, "vertical" head style, or "high mast" style. However, in certain circumstances "shoebox" style luminaires are being used. Shoebox style luminaires are often appropriate for the interior lights in rest areas. Where a municipality is maintaining the lights, other decorative luminaires may be used.

Luminaires should only have photocells when the electrical service point (feedpoint) does not provide photoelectric control.

Several images of standard luminaire types follow.

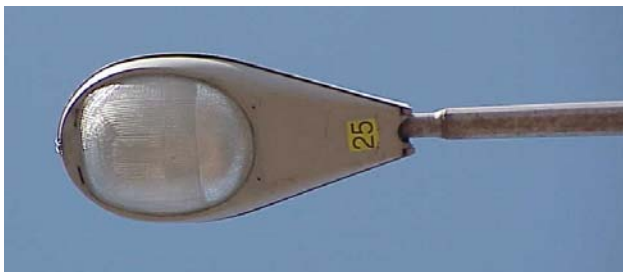

Cobra Head Style Luminaires



Vertical Mount Style Luminaires



High Mast Style Luminaires



Shoebox Style Luminaires

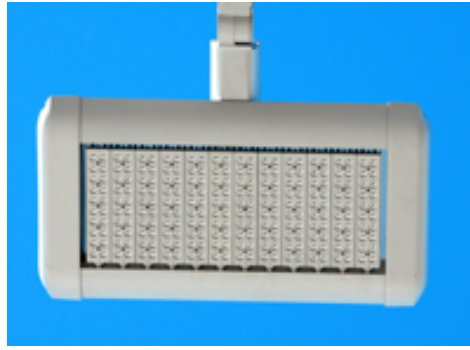

Rest Area Luminaires (Shoebox with Drop Lens on left and LED on right)



Bridge Underpass Luminaire

2.1.1 Optical System

The optical system of a luminaire consists of the lamp, reflectors, and refractors. Each of these elements is described below.

The most important element of the illumination system is the light source. It is the principal determinant of the visual quality, economy, efficiency, and energy conservation aspects of the illumination system. An electric light source is a device, which transforms electrical energy, or power (in watts), into visible electromagnetic radiation, or light (lumens). The rate of converting electrical energy into visible light is called “luminous efficacy” and is measured in lumens per watt.

The figure below illustrates the “family tree” of lamps.

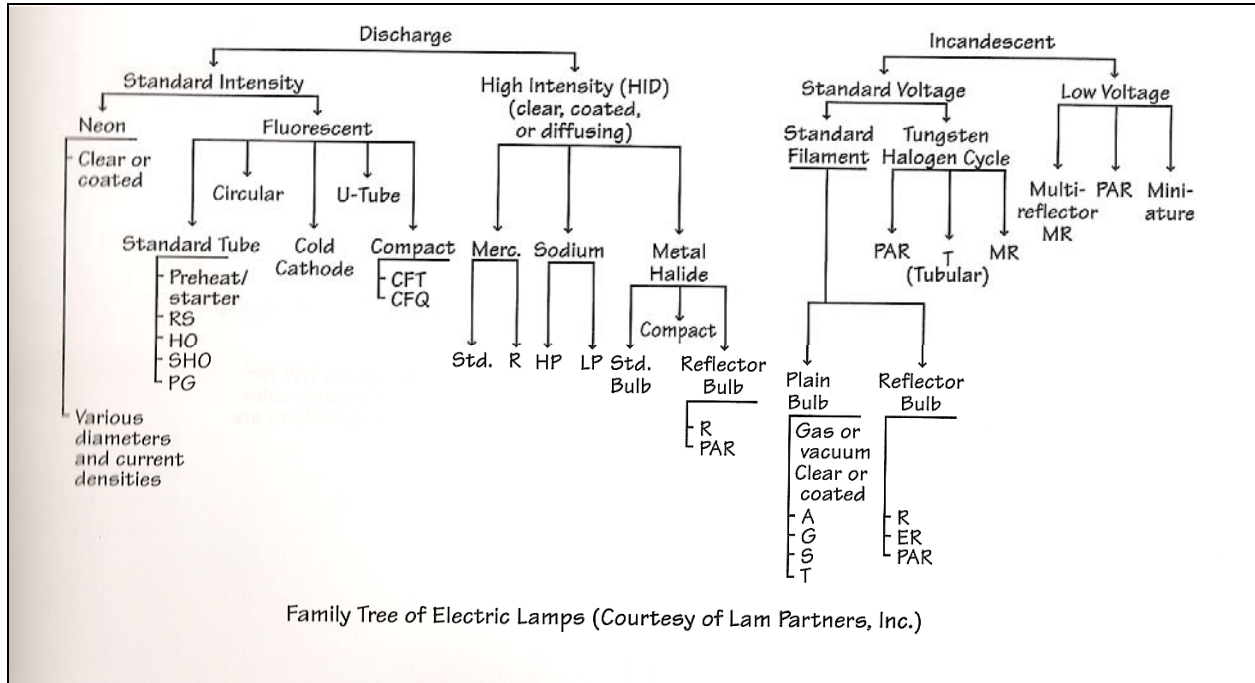

High Intensity Discharge (HID) lamps are currently used for the majority of Mn/DOT lighting projects. There are some projects using LEDs such as at rest areas. LED lights were also installed on the I-35W bridge and are being investigated for use on highways.

General characteristics for roadway lamps are shown in the table below.

Type of Light	Initial Light Output lumens x 10 ³	Approximate Efficacy lumens/Watt	Approximate Lamp Life hours x 10 ³ ²
Metal Halide	34-100	85-100 ¹	10-15
High Pressure Sodium	9.5-140	95-140 ¹	15-28
Low Pressure Sodium	1.8-33	100-183 ¹	10-18
Induction Lighting	3.5-12	67-74 (based on 100 h)	100
Light Emitting Diode (LED) ³	16-20	71	50

Notes:

1. These values exclude wattage losses due to ballast.
2. Number of hours for a group of lamps at which 50 percent will remain in operation; based on 10 hours of operation per start.
3. Estimated values.

Various roadway lighting lamps have been used over the years. A description of the lamp and the Mn/DOT practice regarding its use is included in the paragraphs below.

2.1.1.1 Incandescent or Filament Lamp

A description of the incandescent or filament lamp is as follows:

- Was the most commonly used for many years and was inexpensive, simple, and easy to install.

- Produced pleasing color rendition.
- Its small size permitted good light control with a reasonably sized fixture.

Mn/DOT practice regarding the use of the incandescent or filament lamp is as follows:

- The incandescent lamp is rarely if ever used for roadway lighting because of its low efficiency and short lamp life in comparison with HID light sources.

2.1.1.2 Fluorescent Lamp

A description of the fluorescent lamp is as follows:

- Its large size makes it difficult to obtain good light control in reasonably sized luminaires.
- Its light output is affected by low temperature more than other lamps (is adversely affected by cold weather).
- Its one advantage is the broad light patterns that it provides on wet streets.
- Has shown a poor maintenance history.
- Requires a ballast.

Mn/DOT practice regarding the use of the fluorescent lamp is as follows:

- No longer used for new roadway and sign lighting installations.

2.1.1.3 Mercury Vapor Lamp

A description of the mercury vapor lamp is as follows:

- Replaced the incandescent lamp in popularity. The initial cost is higher and it requires a ballast, but its relatively high efficacy and long life (when it was introduced) make it considerably more attractive than the incandescent lamp. However, it does not meet current energy standards.
- The blue-white color of the clear lamp is generally acceptable, and the arc tube size provides a light source that is small enough to permit good light control. A phosphor-coated outer bulb, featuring both higher output and more pleasing color rendition, is also available. However, since light control is more important in roadway lighting than color rendition, clear lamps are normally used.

Mn/DOT practice regarding the use of the mercury vapor lamp is as follows:

- No longer used for new roadway and sign lighting installations.

2.1.1.4 Metal Halide (MH) Lamp

A description of the MH lamp is as follows:

- Is a type of mercury lamp in which the arc tube contains, in addition to mercury, certain iodide compounds that improve both the efficacy and the color rendition without the use of a phosphor-coated bulb.
- The light source size is that of the arc tube, permitting good light control in the same fixture used for clear mercury lamps and excellent color rendition; however, lamp life is low.
- The color value of the metal halide lamp is good and phosphor is not required. This lamp is often used in parking lots due to the color rendition.
- There are two versions of the lamp, one designed for basedown operation and the other for baseup operation. The lamp must operate in the proper position.

Mn/DOT practice regarding the use of MH lamp is as follows:

- Are occasionally used on Mn/DOT projects because of the elimination of the mercury vapor luminaires.
- Installations are in rest areas and weigh stations.
- Some are in operation as part of high mast tower lighting and rest area lighting.

2.1.1.5 High Pressure Sodium (HPS) Lamp

A description of the HPS lamp is as follows:

- Replaced the mercury lamp.
- Characterized by a golden-white color light output.
- Emits light across the spectrum with predominance in the orange-yellow region.
- Normally operated with special ballasts that provide the necessary high voltage to start the lamp.
- Usually cycles on and off at the end of normal life.
- Some of the newer HPS lamps include:
 - Improved color rendition.
 - Internal starting devices that operate with mercury or metal halide lamp ballasts.
 - Dual arc tube or "standby" lamps that provide light as soon as power is restored after a momentary power interruption and that, in addition, have a rated life of 40,000 hours.
 - End of life indicators

Mn/DOT practice regarding the use of HPS lamp is as follows:

- The most commonly used by Mn/DOT
- Very efficient and is the best for most roadway lighting.
- Not good for use on signs because the light it produces does not render the proper colors on standard signs.

2.1.1.6 Low Pressure Sodium (LPS) Lamp

A description of the LPS lamp is as follows:

- Characterized by a monochromatic bright yellow color light output.
- This lamp requires special ballasts and increases materially in size as the wattage increases; the 185-W lamp is 3.5 feet long. This large size makes it difficult to obtain good light control in a reasonably sized fixture.
- The poor color rendition and large size of the LPS lamp have made it unpopular for use in other than industrial or security applications.
- The LPS lamp is a very efficient light source in that it provides the most light for the same amount of electricity of any of the light sources described.
- LPS lighting has proven to have maintenance problems requiring frequent lamp replacement.

Mn/DOT practice regarding the use of the LPS lamp is as follows:

- Mn/DOT does not use LPS light sources.

2.1.1.7 Induction Lamp

A description of the induction lamp is as follows:

- White light
- 60,000 to 100,000 hour life
- Good color rendition
- No flickering or noise

Mn/DOT practice regarding the use of the induction lamp is as follows:

- Mn/DOT has used this in Rest Areas.

2.1.1.8 Light Emitting Diode Lamp

A description of the lamp is as follows:

- White light
- 60,000 to 100,000 hour life
- Good color rendition

Mn/DOT practice regarding the use of the LED is as follows:

- Mn/DOT has used this in Rest Areas, on the I-35W Bridge and is investigating for use on highways.

The efficiency of a lamp in converting electrical energy to light, the ability of the lamp to maintain its light output over the course of the lamp life, the length of the lamp life, the color of the light, and the distribution of the light are all factors which affect the cost and effectiveness of installing, operating, and maintaining the lights; therefore, they all affect the choice of light source.

The reflector is used to change the direction of the light output. Its purpose is to redirect the otherwise wasted light output in the direction desired.

The refractor controls and redirects the light emitted by the lamp and coming off the reflector by means of its prismatic construction. The refractor also serves to protect the lamp from external damage.

2.1.2 Electrical System

The component of the luminaire's electrical system discussed in this section is the ballast. A ballast is required for all HID and fluorescent lamps. A ballast generally serves the following three functions:

- Provides the proper open circuit voltage to start the lamp (some HID lamps require an additional igniter to achieve proper starting voltage).
- Keeps the lamp operating within its design parameters. HID lamps have a very low inherent operating resistance or impedance. Furthermore, if no ballast controls an operating HID lamp, the current would increase continually causing the impedance to decrease continually, causing the current to continually increase even more. This cycle will continue until the lamp burns out. This phenomenon is called negative resistance. The ballast provides a control function and limits the power available to the lamp.
- Adapts the lamp to any one of the line voltages commonly available.

Mn/DOT uses magnetic regulating type ballasts. A table summarizing ballast characteristics is presented below for the types of ballasts Mn/DOT uses.

Ballast Type	Line Voltage	Variation in Lamp Wattage vs. Line Voltage		Power Factor (min)	Starting Current	Lamp Current Crest Factor	Ballast Losses
		Line Volts	Lamp Watts				
Regulated LAG	120/240 v or 240/480v	± 10 %	± 3 %	90% +	Lower than operating	1.6-1.8	17-30 %

Ballasts for high pressure sodium lamps are located in the luminaire.

2.1.3 Mechanical System

The mechanical system of a luminaire serves to package all of the optical and electrical components in an orderly fashion. It consists of the luminaire housing, the lamp socket support, the slipfitter, a hinge and latching mechanism to allow ready access to the luminaire interior, and an assortment of miscellaneous hardware. These components are not discussed in detail in this manual.

2.2 Luminaire Support System

2.2.1 Mast Arms

Mast arms support the luminaire at a lateral dimension from the pole. Mast arm length is usually 6 feet, 9 feet or 12 feet. Conventional lighting units should have davit type mast arms (telescoped onto the top of the pole) or tenon type mounting assembly unless a desire for decorative lighting dictates another type of arm, or unless the lights must match existing light poles with a different type of arm.

2.2.2 Poles

2.2.2.1 Pole Height

Pole height affects the illumination intensity, uniformity of brightness, area covered, and relative glare of the unit. Higher mounted units provide greater coverage, more uniformity, and a reduction of glare, but a lower footcandle level. By using higher poles, fewer poles are required and they can be set back farther from the traveled roadway. Typical pole heights are 30 feet, 40 feet, and 49 feet. Power lines, nearby airports, and nearby residential neighborhoods may limit the height of poles used for lighting. Where pole height is not restricted, high mast tower lighting may replace conventional lighting units at locations with complex roadways, such as at freeway interchanges. High mast tower luminaires have mounting heights varying from 100 feet to 140 feet.

2.2.2.2 Pole Type

The various pole types are as follows:

- | | |
|----|--|
| A | Anchor bolt pole (no transformer base) |
| B | Barrier or bridge mounting (6 bolt cluster) |
| C | Corten steel (no finish applied) |
| D | Double mast arms |
| M | Ornamental style pole |
| P | Painted pole |
| S | Combination traffic signal and street light pole |
| W | Wood pole lighting unit (for temporary lighting) |
| X | Decorative pole (with inclined beam arm) |
| VM | Vertical mount |

2.2.2.3 Pole Designations

Generally, the pole type designation contains the mast arm length, nominal pole height, and the type of pole. The pole designation is read as follows:

- The first number before the dash is the mast arm length.
- The character(s) just preceding the dash indicates the type of pole used. If no characters are in this position, the pole has a transformer base or high base, is intended for mounting on a light base, and has no finish for an aluminum or stainless steel pole or is galvanized for a steel pole.
- The numbers after the dash give the nominal pole height.

The following are examples of pole designations:

1. 9-40. 9' mast arm with 40' mounting height, transformer base or high base, and aluminum or stainless steel, as indicated in the plans.
2. 6BD-40. 6' double mast arms with 40' mounting height, provisions for barrier mounting.
3. VMD-45. Tenon mount double mast arm vertical luminaire with 45' mounting height.

The following pictures illustrate various poles and their designations.



Bentstraw Type Pole (6X-40)



Bridge Pole (6B-40)



Standard Pole with 9 Foot Davit (9-40)



Double Davit Arm (6D-49)



Double Vertical Mount Pole Arrangement (VMD-45)



High Mast Tower Poles (3-100, 4-100, etc.)

2.2.2.4 Breakaway Poles

The latest version of the "Standard Specifications for Structural Supports for Highway Signs, Luminaires and Traffic Signals", published by AASHTO, specifies structural requirements for light poles. The Federal Highway Administration may have requirements differing from those found in this AASHTO standard, particularly with regard to breakaway devices, and the lighting system designer should check on such requirements before specifying types of poles for a lighting project.

A breakaway pole has a special base and has been tested as a complete unit to show that it will "break away" when hit and will not impede a vehicle's movement more than a maximum amount. Breakaway poles must meet 2001 AASHTO breakaway requirements. Mn/DOT's standard aluminum and stainless steel poles have been tested to meet breakaway requirements. The following should be used when determining if a breakaway pole is needed:

- *Where traffic speeds exceed 40 mph*, any poles located within the "clear zone" (see the Mn/DOT Road Design Manual for the definition of "clear zone") must either be breakaway devices, or must be protected by a suitable traffic barrier (guardrail).
- *In urban areas with speeds less than 30 mph and pedestrians present*, a knocked down pole may present a greater hazard to traffic and pedestrians than would a non-breakaway device. Non-breakaway poles should be used in these locations.
- *In urban areas with speeds between 30 mph and 40 mph*, the designer may choose either breakaway poles or non-breakaway poles. These criteria for the use of breakaway poles apply regardless of the state's participation in the project.

Types of pole bases include the tapered high base, the anchor base, the shoe base, and the standard transformer base. Types of breakaway poles include the stainless steel progressive shear base with a stainless steel shaft, the frangible cast aluminum transformer base with an aluminum pole shaft and arm, a slip base pole, and an aluminum shoe base pole.

2.2.2.5 Pole Placement

Pole placement is an engineering decision which should be based upon geometry, character of the roadway, physical features, environment, available maintenance, economics, aesthetics, and overall lighting objectives.

Physical roadside conditions may require adjustment of the pole spacing determined from the base levels of illumination, as indicated in the *AASHTO Roadway Lighting Design Guide*. Higher levels of illumination are justified when overhead structures, safety, and object clearances restrict the placement of poles. It is advisable to provide higher illumination levels at diverging and merging areas.

Site considerations affecting pole placement include noise walls, existing guard rail, rock, narrow roadside clearances, power lines, nearby airports, traffic signals and nearby residential neighborhoods. If space does not permit, poles may be placed behind noise walls, however, access must be provided for maintenance. Poles should be placed at least two feet behind any existing guard rail, or at a distance that will allow the guard rail to properly deflect upon impact. When street lights are installed in conjunction with traffic signals, the lights should be installed on the same poles as the traffic signals, if possible.

The following pole placement practices regarding curves should be followed:

- Long radius curves may be lighted as a straight roadway.
- Luminaires mounted on the inside of a short radius curve require closer spacing in order to produce adequate pavement brightness on the curved section, but are preferred over the outside of a short curve.
- Light poles on the inside of a banked curve should be placed such that they will not be hit by trucks.

Additionally, light pole placement should consider maintenance. Bucket trucks must be nearly level to operate and are limited in the height and distance from the roadway that the bucket can reach. Different types of trucks may have different working ranges. Finally, poles should be placed to minimize knockdowns. Pole setback is also an important consideration for clear zone requirements. Discussion on pole set back is discussed in section 4.1.6.

2.2.3 Light Bases/Foundations

In order to adequately support the lighting structure, the foundation must be designed to support the weight of the structure as well as resist wind loads and vibrations. The four standard light bases that Mn/DOT uses are P, E, H, and tower. Poles mount on the bases according to the pole height as follows:

- P Base (concrete or steel): ≤ 20 foot poles
- E Base (concrete or steel): ≤ 40 foot poles
- H Base (concrete): ≤ 49 foot poles (Steel H Base design not approved at this time)

These light bases and the anchorage for light standards mounted on a bridge or median barrier are detailed in the Mn/DOT Standard Plates Manual. Standard Plates 8127 and 8128 describe bases E and H respectively and are located in the Appendix. A detail sheet for the P type base is also included in the Appendix. A tower base detail sheet is included in the 35W sample plan located in Chapter 6. Pole anchorages in a median

barrier require a specially widened section of the barrier, called an AL section, to be itemized in the road plans.



Steel Base (E or P)

Concrete Base (E, H, or P)

Tower Type Bases

A concrete equipment pad includes the following:

- Conduit and anchorage hardware within the concrete foundation
- Reinforcement bars if using the precast option
- All wiring and hardware necessary
- All grounding bonding materials as indicated in the details in the plan

Standard Plates 8105 and 8106 are included in the Appendix and describe equipment pads A and B respectively. Equipment pads A and B are standard concrete foundations used by Mn/DOT; however, other non-standard pads are occasionally used.

2.2.4 Mn/DOT Standard Luminaire and Support System Types

A limited number of standard luminaire and support system types have been approved for Mn/DOT use. The state will construct, maintain and pay for the power costs associated with these systems if agreed upon. The following are Mn/DOT's standard luminaire and support system types:

2.2.4.1 Davit Pole/Cobra Head Luminaire

- 250 - 400 watt HPS lamp
- 6 foot - 12 ft davit style mast arm
- 40 foot – 49 ft round tapered (16 sided) stainless steel or round tapered aluminum pole, or
- 40 foot – 49 ft galvanized steel pole (bridges, retaining walls and median barriers)

2.2.4.2 Bent Straw Pole/Shoebox

- 250 watt HPS lamp
- 6 foot straight tapered mast arm

- 30 foot - 40 foot painted square tapered stainless steel or galvanized aluminum pole

2.2.4.3 Tenon Top Pole/Vertical Mount Luminaire

- 250 - 400 watt HPS lamp
- Pole top or twin bullhorn bracket mount
- 40 - 49 foot round tapered (16 sided) stainless steel or round straight aluminum pole

2.2.4.4 High Mast Towers

- 1000 watt HPS lamp
- 3 - 6 luminaires per tower
- 100 foot - 140 foot corten steel pole with stainless steel luminaire support ring

2.2.4.5 Rest Area

- Walkway light poles with 12" arm and shoebox luminaire
- 400 watt MH, induction or LED in parking lot
- 12-foot painted 4" square steel poles
- Mn/DOT is working on standardizing all rest area lighting styles to make maintenance easier and avoid a mix of styles due to the availability of products. Discuss with the District Office to confirm the standard.

2.3 Selection of Lighting Equipment

Mn/DOT utilizes the following four types of lighting equipment combinations:

- Cobra Head
- Vertical Mount
- High Mast
- Shoebox

2.3.1 Cobra Head Lighting Equipment

For roadway configurations with two or three lanes in each direction, the most common equipment used is the following:

- 250 watt HPS cobra head style luminaire
- Davit type mast arms
 - 9 foot on ramps and loops
 - 9 or 12 foot on the through roadway
- 40-foot pole
- Spacing of the 40-foot poles is usually 240 to 250 feet, depending on the desired footcandle level and the number of lanes.
- When circumstances allow, Mn/DOT can use shoebox luminaires on light poles.

When lighting a roadway configuration with three or more lanes, the following is used:

- A mixture of 40-foot poles and 49-foot poles can be used.
 - 40-foot poles should be used on the ramps and loops.
 - 49-foot poles should be used on the through roadway.
- The 49-foot poles can be roadside mounted lighting units or median barrier mounted lighting units.
- The 49-foot pole lighting unit should have a 400 watt HPS luminaire and be spaced 280 to 300 feet apart.
- Median barrier lighting units should have twin 6-foot mast arms and roadway mounted lighting units should have 9 or 12-foot mast arms.

2.3.2 Vertical Mount Lighting Equipment

When adequate clearance and slopes are available, vertical mount lighting units may be utilized. The vertical mount poles are typically 45-foot poles with single or double tenon mounted with a 250 watt HPS luminaire. 49-foot poles may also be utilized with a 400 watt HPS luminaire. Vertical mounted poles can be used on median barriers and bridges.

If using vertical mount lighting, ensure that this meets State Statute on Energy Law as described in Section 1.6.

2.3.3 High Mast Lighting Equipment

The third type of equipment Mn/DOT uses is high mast lighting. High mast lighting implies an area type of lighting with three to six 1000 watt HPS luminaires mounted on free standing poles or towers, at mounting heights varying from approximately 100 feet to 140 feet or more. At these mounting heights, high output luminaires develop a highly uniform light distribution.

High mast lighting is used principally where continuous lighting is desirable such as interchange lighting, lighting of toll plazas, rest areas and parking areas, general area lighting, and for continuous lighting on highways having wide cross sections and a large number of traffic lanes.

High mast lighting is also desirable where there is minimal residential and where maintenance of conventional lighting units may be a hazard to the traveling public and the maintenance personnel. Attention to residential activity is crucial since some installations of high mast lighting have resulted in local citizen complaints due to the amount of lighted area and the visibility of the light source.

The principal benefits of high mast lighting applications are the ability to provide excellent uniformity of illumination and reduce glare with a substantially smaller number of pole locations. This is especially true in interchange and other complex road areas.

While utilization efficiency is low on individual roadways, several roadways can usually be illuminated from the luminaires on a single pole. The off road surrounding areas receive sufficient illumination to provide the motorist with an exceptionally wide illuminated field of vision compared to the "tunnel of light" effect provided by a conventional system. Performance of the system under adverse weather conditions such as rain, fog, etc. is good.

High mast lighting generally provides its own transition lighting to and from unlighted roadways.

High mast lighting makes a contribution to safety and aesthetics by reducing the number of poles that would be required for a conventional system and through locating poles out of the recovery area adjacent to the driving lanes. Also, their remote location eliminates the need for maintenance vehicles obstructing traffic on the roadway, or the requirement for maintenance personnel to be near the high speed traffic lanes.

The design and installation of high mast lighting equipment is more complex than conventional lighting. Poles or towers with lowering devices or other methods of luminaire servicing require special design and maintenance considerations.

The most common type of luminaire used in high mast lighting is the area type, which is offered having symmetric or asymmetric distribution. Both types of distribution are frequently used to adequately fit the area to be lighted, and to minimize spill light.

2.3.4 Shoebox Lighting Equipment Options

There are cases where a more decorative lighting system is desired. Painted bronze poles with bronze shoebox luminaires and an inclined beam mast arm are the only decorative lighting that Mn/DOT will maintain. The painted poles can be used on median barriers and bridges.

The shoebox luminaire should only be used on two-lane roadways. The poles should be 35-40 feet with a 6 foot inclined beam mast arm and 250 watt HPS luminaires. The spacing of these poles must be calculated for each installation.

2.4 Service Cabinets

The electrical service point (feedpoint) consists of a lighting service cabinet complete with the following:

- Circuit breakers and photoelectric control where applicable
- A concrete foundation or wood pole for mounting
- Electrical connections to the power company service conductors
- Provisions for grounding
- A meter and meter socket when necessary.

See Standard Plate 8140 for service cabinet wiring.

2.4.1 Service Cabinet, Secondary Type L2

This is a pad mounted service cabinet with power distribution blocks, 2-100 ampere 2-pole circuit breakers and 16-20 ampere double pole branch circuit breakers. This allows for eight 4-wire circuit runs from the cabinet consisting of two current carrying conductors, one neutral conductor and a ground. Each circuit having a load capacity of 32 amps. In a 240 volt system this can accommodate 213-250 watt HPS luminaires and in a 120 volt system 98-250 watt HPS luminaries (if voltage drop permits). A photocell is provided in this service cabinet.

2.4.2 Service Cabinet, Secondary Type L1

This is a pad mounted service cabinet with power distribution blocks, with a 100 ampere 2-pole main circuit breaker and 8-20 ampere single pole branch circuit breakers. This allows for four 4-wire circuit runs from the cabinet consisting of 2 current carrying conductors, one neutral conductor and a ground. Each run having a load capacity of 32 amps. In a 240 volts system this can accommodate 106-250 watt HPS luminaires and in a 120 volt system 49-250 watt HPS luminaries (if voltage drop permits). A photocell is provided in this service cabinet.



Type L1 or L2 Cabinet

2.4.3 Service Cabinet, Secondary Type A

This pole mounted service cabinet is identical to a pad mounted Type L1, with a 100 ampere 2-pole main circuit breaker and 8-20 ampere single pole branch circuit breakers. This allows for four 4-wire circuit runs from the cabinet consisting of 2 current carrying conductors, one neutral conductor and a ground. Each run having a load capacity of 32 amps. In a 240 volts system this can accommodate 106-250 watt HPS luminaires and in a 120 volt system 49-250 watt HPS luminaries (if voltage drop permits). A photocell is provided in this service cabinet.



Type A Cabinet

2.4.4 Service Cabinet, Secondary Type B

This pole mounted service cabinet has a 60 ampere 2-pole main circuit breaker and 4-20 ampere single pole branch circuit breakers. This allows for two 4-wire circuit runs from the cabinet consisting of 2 current carrying conductors, one neutral conductor and a ground. Each run having a load capacity of 32 amps. In a 240 volts system this can accommodate 53-250 watt HPS luminaires and in a 120 volt system 24-250 watt HPS luminaires (if voltage drop permits). A photocell is provided in this service cabinet.

The service cabinets described above can accommodate the number of lights indicated, if it does not exceed a three percent voltage drop or a total system voltage drop of five percent.



Type B Cabinet

2.4.5 Service Cabinet, Type RLF

This type of cabinet is a pad mounted, rain tight enclosure with pad mounting gasket. It is rectangular in shape with the top of the cabinet extending over the front door and back wall. The outside dimensions are 60 inches high, by 20 inches wide, by 20 inches deep and has the roof of the cabinet extend beyond the outer edge of the front door and back wall of the cabinet. This overhang will reduce the amount of water that could potentially collect at the sealed top of the cabinet door opening. The RLF shall have Cross-Brakes in the roof and have two separate compartments (a front and back compartment).

3. PHOTOMETRY

In this Chapter you will be introduced to photometry as it relates to roadway lighting design. The items covered include photometrics and lamp and luminaire depreciation factors.

This chapter covers the basics of light source test data, depreciation factors that affect the performance of light sources and the terminology used in discussing lighting source physics.

3.1 Photometrics

The term Photometry is used to define any test data which describe the luminaire's light output characteristics. The most common types of photometric data include isofootcandle performance charts, coefficient of utilization curves, vertical and lateral light distribution data, lumen maintenance curves, and dirt depreciation curves. The purpose of photometry is to accurately describe the performance of a luminaire to enable the designer to select the lighting equipment and to design a layout plan which best meets the needs of the job.

A review of the more frequently used types of photometric data follows.

3.1.1 Coefficient of utilization

The coefficient of utilization (CU) is the ratio of the luminous flux (lumens) from a luminaire received on the roadway surface to the lumens emitted by the luminaire's lamp alone. The utilization curve defines how much of the total lumen output reaches the area being lighted and is provided for luminaires intended for outdoor use. A Utilization Curve for a typical cobra head HPS luminaire is shown below.

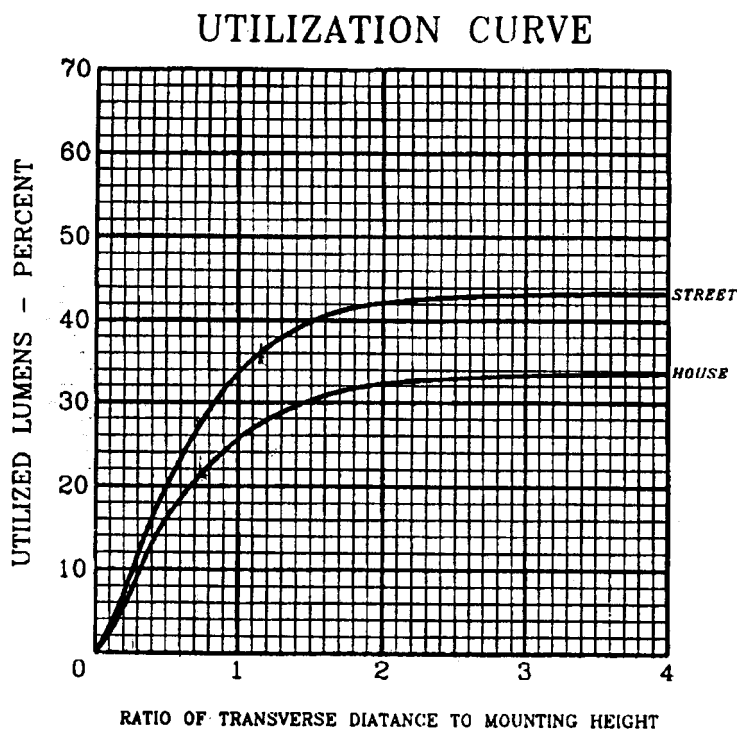

Two curves are shown in the graphic, one for the street side (normally the desired area to be lit) and one for the house side (the direction away from the primary lit direction). The street curve represents the utilization of the bare lamp, in percent, as the ratio of transverse distance to mounting height increases.

CU Calculation Example:

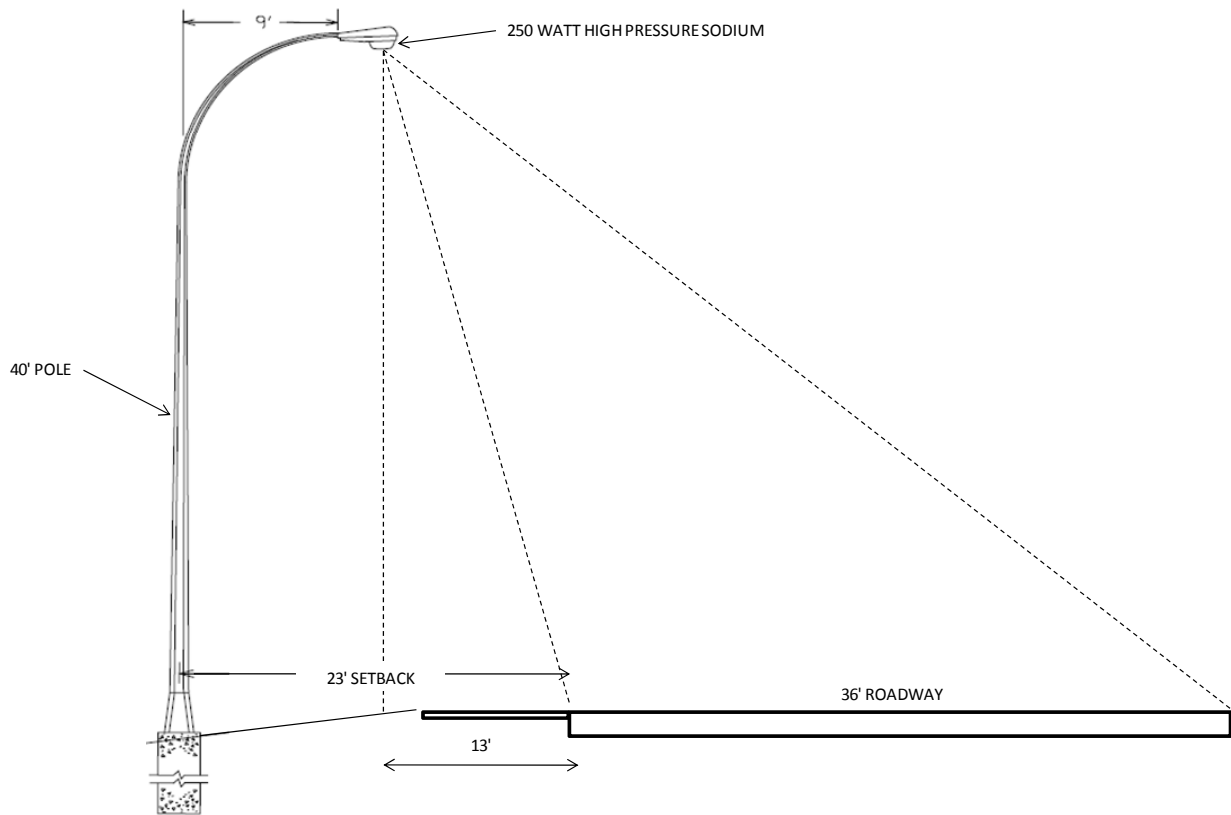

The CU is computed as follows:

1. To obtain the pavement area CU, enter the CU curve for the Street Side at the correct transverse distance to mounting height ratio. In this case, the ratio would be $(36 + 13)/40$ or 1.23. Follow the chart up until you reach the Street curve and read the Utilized Lumens (in percent). This results in 37 percent.
2. To obtain the shoulder area CU, enter the CU curve for the Street Side at the correct transverse distance to mounting height ratio. In this case, the ratio would be $13/40$ or 0.33. Follow the chart up until you reach the Street curve and read the Utilized Lumens (in percent). This results in 13 percent.
3. The CU from the "triangle" that forms from the luminaire to the near pavement edge is subtracted from the "triangle" that forms from the luminaire to the far side pavement edge. This results in a CU of approximately 24 percent.

3.1.2 Isofootcandle chart

An isofootcandle chart is used to describe the light pattern a luminaire produces. These charts show exact plots or lines of equal footcandle levels on the work plane with the fixture at a designated mounting height.

An isofootcandle curve for a typical cobra head HPS luminaire is shown below.

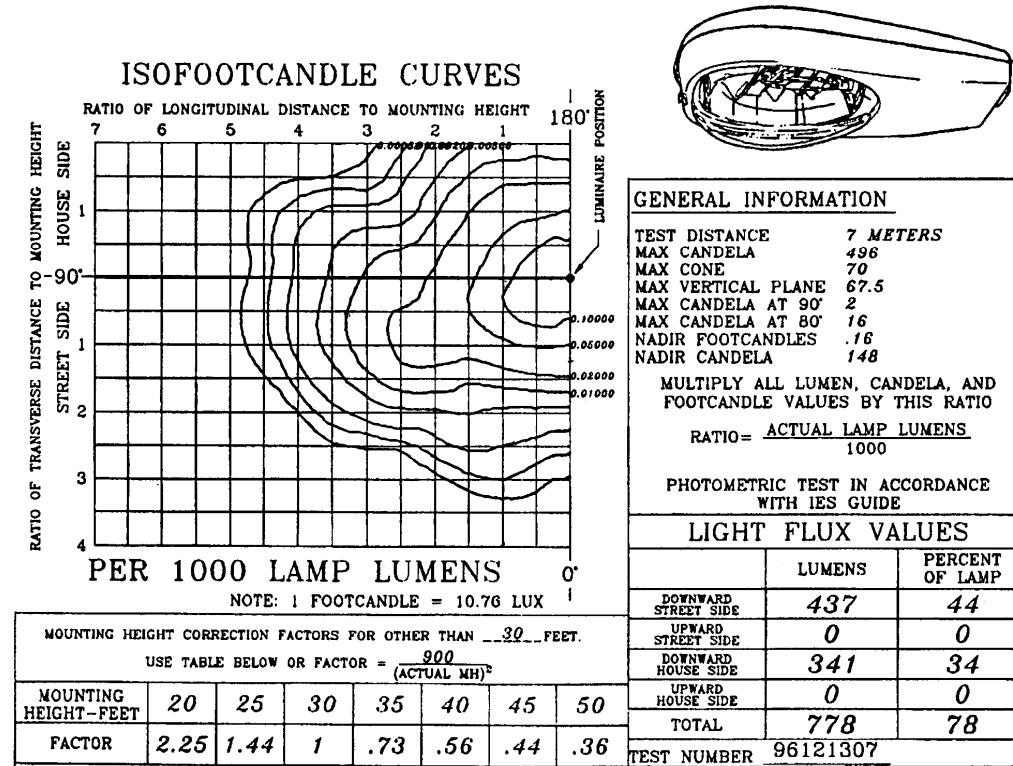

Once the CU is determined, the isofootcandle chart can be used to determine the Minimum Maintained Illumination Value and other discrete points in the system.

Isofootcandle Chart Example:

Before using the isofootcandle chart, the point at which the minimum maintained illumination value is desired must be determined. For purposes of example, assume 120 feet to the right or left of the current position. This is a longitudinal distance along the roadway that will depend on actual pole spacing. The following steps should be followed:

1. Enter the isofootcandle chart at the Luminaire Position point and move left to the correct Ratio of Longitudinal Distance to Mounting Height. In this case the ratio would be 120/40 or 3.0.
2. If required, move up or down to correct for the exact luminaire position in relation to point of interest (no correction for our example).
3. Read the illumination factor directly from the isobar, use interpolation if required. In this case, the value would be ~0.011. This value represents the uncorrected footcandles at the location tested.

This information is used to determine the proper spacing and design standards, which are discussed in detail in Chapter 4.

3.1.3 Vertical Light Distributions

Vertical light distributions are characteristics of the luminaire and should be considered early in the design process. Vertical light distributions are divided into three groups, short, medium, and long. Classification is based on the distance from the luminaire to where the beam of maximum candlepower strikes the roadway surface. Each distribution is defined below.

Short distribution. The maximum candlepower beam strikes the roadway surface between 1.0 and 2.25 mounting heights from the luminaires.

Medium distribution. The maximum candlepower beam strikes the roadway at some point between 2.25 and 3.75 mounting heights from the luminaires.

Long distribution. The maximum candlepower beam strikes the roadway at a point between 3.75 and 6.0 mounting heights from the luminaires.

On the basis of the vertical light distribution, theoretical maximum spacing is such that the maximum candlepower beams from adjacent luminaires are joined on the roadway surface. With this assumption, the maximum luminaire spacings are:

- Short distribution - 4.5 mounting heights
- Medium distribution - 7.5 mounting heights
- Long distribution - 12.0 mounting heights

From a practical standpoint, the medium distribution is used by Mn/DOT, and the spacing of luminaires normally does not exceed five to six mounting heights. Short distributions are not used extensively for reasons of economy, because extremely short spacing is required. At the other extreme, the long distribution is not used to great extent because the high beam angle of maximum candlepower often produces excessive glare.

3.1.4 Lateral Light Distributions

As with vertical light distributions, lateral light distributions are characteristics of the luminaire and should be considered early in the design process. The Illuminating Engineering Society established a series of lateral distribution patterns designated as Types I, II, III, IV, and V. In general, we may describe Types I and V as luminaires mounted over the center of the area to be lighted. Type I applies to rectangular patterns on narrow streets, while Type V applies to areas where light is to be distributed evenly in all directions. Type V and a modified Type I are generally the class of luminaire applied in high mast lighting systems.

Types II, III, and IV are classes of luminaires to be mounted near the edge of the area to be lighted. Type II applies to narrow streets, Type III to streets of medium width, while Type IV applies to wide street applications. These are illustrated as follows.

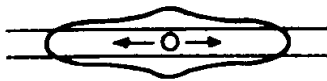

(A) TYPE I

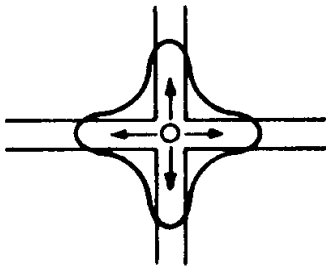

(B) TYPE I - 4-WAY

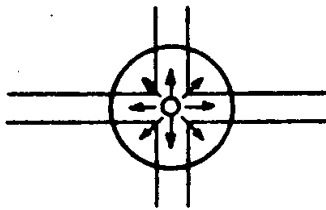

(C) TYPE V

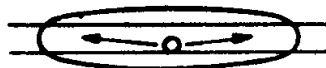

(D) TYPE II

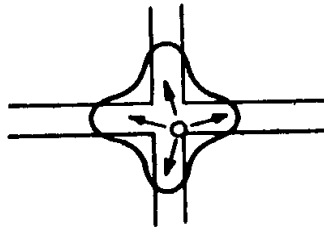

(E) TYPE II - 4-WAY



(F) TYPE III



(G) TYPE IV

3.2 Lamp and Luminaire Depreciation Factors

In determining the light output for a luminaire, the lighting system designer must consider the luminaire light loss factor. The luminaire light loss factor is a combination of several factors, including the Lamp Lumen Depreciation Factor (LLD) and the Lamp Dirt Depreciation Factor (LDD). Terms associated with this topic are defined as follows:

Initial Lamp Lumens (LL) - initial bare bulb lumen output of a light source.

Lamp Lumen Depreciation Factor (LLD) - a design factor used to depreciate the output of a lamp due to life-cycle output reduction. Mn/DOT uses a LLD = 0.90.

Luminaire Dirt Depreciation Factor (LDD) - a design factor used to depreciate the output of a lamp due to dirt affecting the interior and exterior of the luminaire and to some extent the lamp itself. Various degrees of dirt accumulation may be anticipated depending on the area in which the luminaire is located. Mn/DOT uses a LDD = 0.90.

The loss factor is applied to the initial lamp lumens to determine the light output of the luminaire after a fixed period of time (maintained light output). The AASHTO *Roadway Lighting Design Guide* discusses the different aspects of the light loss factor. With these considerations, the factor to apply to arrive at a maintained light output value for the luminaire is an educated guess. However, as stated above, Mn/DOT uses a LLD of 0.90 (for HPS) and a LDD factor of 0.90, resulting in a combined 0.81 factor. The standard light loss factor would represent a loss of 19 percent of the initial lumen output accounting for output loss due to burn time and dirt covering the luminaire. Adjustments to these factors are warranted under special circumstances.

The LLD and LDD factor nomographs are illustrated to the right.

the
Very
that

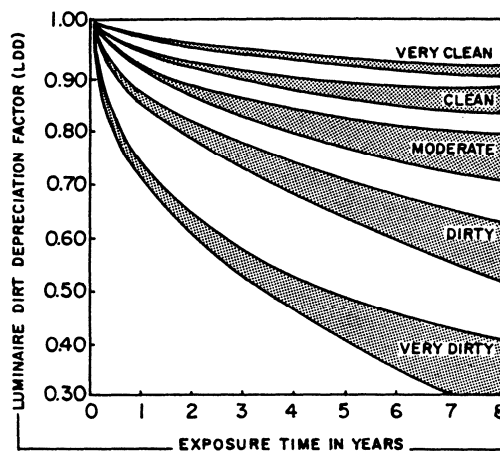

per cubic meter.

Moderate – Moderate smoke or dust generating activities nearby. The ambient particulate level is no more than 600 micrograms per cubic meter.

Dirty – Smoke or dust plumes generated by nearby activities may occasionally envelope the luminaires.

Very Dirty – As above but the luminaires are commonly enveloped by smoke or dust plumes.

LUMEN MAINTENANCE

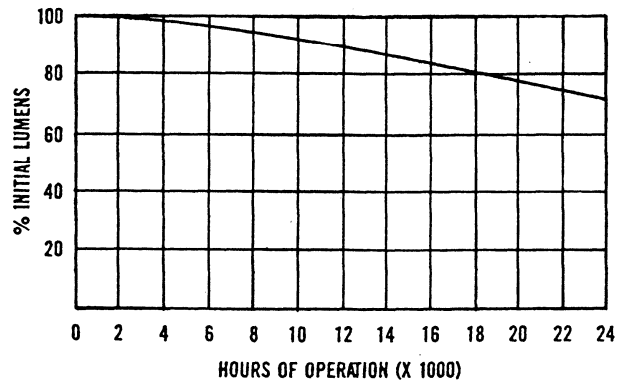

Select the appropriate curve in accordance with type of ambient as described by the following examples:

Clean – no nearby smoke or dust generating activities and low ambient contaminant level. Light traffic. Generally limited to residential or rural areas. The ambient particulate level is no more 150 micrograms per cubic meter.

Clean – No nearby smoke or dust generating activities. Moderate to heavy traffic. The ambient particulate level is no more than 300 micrograms

4. LIGHTING DESIGN

In this Chapter you will be introduced to the Mn/DOT roadway lighting design process. The items covered include:

- Lighting Design
- Sample Letters
- Lighting Design Computer Programs
- Temporary Lighting

This chapter discusses the steps to consider when designing roadway lighting and preparation of a Mn/DOT roadway lighting design project plan set.

Once the decision is made to install new lighting, the design stage can begin. This section describes typical Mn/DOT lighting designs. The design must be appropriate for the site and must provide the level and uniformity of illumination suggested in the *AASHTO Roadway Lighting Design Guide*. The lighting described in this section follows the illumination method of lighting design, which is a measure of light incident on the pavement surface. Lighting design may also be conducted using the luminance method described in the *AASHTO Roadway Lighting Design Guide*, which is a measure of the reflected light from the pavement surface that is visible to the motorist's eye. Both methods produce satisfactory results.

4.1 Mn/DOT Roadway Lighting Design Process

These steps are arranged in the order in which they are usually encountered in the design process. The context in which they are presented is that of a completely new design to be accomplished by an individual with an adequate engineering background, but less than average lighting experience.

4.1.1 Design Step 1. Assess the Facility to be Lit and Determine the Minimum Footcandle Levels

Design Step 1 involves the following:

- Perform preliminary facility assessment checklist to determine specific lighting needs. Use the checklist on the following pages.
- Determine the facility or functional classification of the roadway for which you are designing. Use the recommended footcandle level table to determine minimum footcandle levels and uniformity ratios.

4.1.1.1 Facility Assessment Checklist

T.H _____ at _____ Date _____
Final Design Squad _____ S.P. _____
City _____ County _____
Field Reviewer _____ Speed Limits: _____
Utilities _____ Power Company _____
Funding _____

FACILITY ASSESSMENT

1. Alignment of traffic lanes or number of lanes: _____
2. Are there retaining walls or guardrail in the area: _____
3. Any ground mount or overhead signing: _____
4. Any overhead power lines: _____
5. Width of shoulders (include median shoulders): _____
6. Any sidewalks/paths: _____
7. What is the topography (slopes, grades, etc.): _____
8. Urban or rural: _____
9. Business or residential: _____
10. Any intersecting roadways: _____
11. Describe the basic geometry: _____
12. Speed: _____
13. Any ambient lighting: _____
14. Traffic signals or beacons: _____
15. Median Barrier: _____
16. Any non-standard or ornamental lighting required: _____
17. Do we need to remove or relocate any lighting: _____
18. Do we need to relocate any utilities: _____
19. Which type of lighting system is being installed _____
20. High Mast Lighting
Are there nearby residential areas? _____
Foundation recommendations are required for the bases, date request sent: _____

21. Vertical Mount Lighting

Is there sufficient ROW? _____

22. Standard Cobra Head/Shoebox Lighting

Cutoff or shallow glass: _____

23. Are there bridges involved: _____

Bridge nos: _____

Air obstruction lights required: _____

Navigation lights required: _____

24. What Configuration and type of Lighting System is being proposed

Complete Interchange _____

Partial Interchange _____

Continuously Lit _____

25. Will maintenance agreement with local agency need to be in writing? _____

4.1.1.2 Facility Assessment Notes

The following notes are associated with the numbered Facility Assessment Checklist.

1. A curve could mean the difference between partial and continuous lighting. The number of lanes will affect pole height and wattage or the need to light both sides.
2. Lighting anchorages may be needed in retaining walls. The height of the wall also affects pole height. Poles may be placed closer to roadway if guardrail is in place.
3. Power may be required to light sign. Lights should not be placed too close to sign as this may reflect on sign and affect visibility.
4. Should remain a safe distance from power lines (20 feet is recommended).
5. Affects pole height and wattage.
6. Indicates pedestrians and higher footcandle levels may be desirable.
7. Steep grade may require higher poles.
8. Urban areas generally have continuous lighting while rural areas do not. Also light pollution and light trespass are issues in urban areas.
9. Light trespass is a larger issue in residential areas.
10. Is additional lighting needed on cross street and if so, will an agreement be needed with another entity?
11. None
12. Lighting may not be required if speed limit is below 40 mph.
13. Ambient lighting can reduce or increase the need for lighting.
14. A combined signal and lighting pad (SOP) may be required. Lights on signals will affect spacing.
15. Lights may need to be placed on barrier if there is no room on the outside of the roadway. Generally, lights should not be placed in median because they are hard to maintain.
16. Mn/DOT does not stock parts for this type of lighting; therefore, it is maintained by a municipality or county.
17. The age of the system or maintenance problems would affect removal.
18. None
19. System should match those on either side of project.
20. Will shields keep light out of residential areas?
21. Pole setbacks are 33' to 36' from edge of travel roadway.
22. Cutoffs are used near airports.
23. Navigational lights should have a separate SOP, normally 120/240v metered. Utility companies do not have a rate for air obstruction lights, so they must be metered.
24. None
25. None

4.1.1.3 Recommended Footcandle Levels

The following chart contains the minimum average maintained illumination and maximum uniformity ratios by facility classification and pavement classification.

Minimum Average Maintained Illumination (Eh) and Maximum Uniformity Ratios by Facility Classification and Pavement Classification.

Roadway and Walkway Classification		R1		R2 & R3		R4		Max Unif.
		foot-candles	Lux	foot-candles	Lux	foot-candles	Lux	avg/min
Interstate and Other Freeways	Commercial	0.6 - 1.1	6 - 12	0.6 - 1.1	6 - 12	0.6 - 1.1	6 - 12	3:1 or 4:1
	Intermediate	0.6 - 0.9	6 - 10	0.6 - 0.9	6 - 10	0.6 - 0.9	6 - 10	3:1 or 4:1
	Residential	0.6 - 0.8	6 - 8	0.6 - 0.8	6 - 8	0.6 - 0.8	6 - 8	3:1 or 4:1
Other Principal Arterials	Commercial	1.1	12	1.6	17	1.4	15	3:1
	Intermediate	0.8	9	1.2	13	1.0	11	3:1
	Residential	0.6	6	0.8	9	0.8	8	3:1
Minor Arterial	Commercial	0.9	10	1.4	15	1.0	11	4:1
	Intermediate	0.8	8	1.0	11	0.9	10	4:1
	Residential	0.5	5	0.7	7	0.7	7	4:1
Collectors	Commercial	0.8	8	1.1	12	0.9	10	4:1
	Intermediate	0.6	6	0.8	9	0.8	8	4:1
	Residential	0.4	4	0.6	6	0.5	5	4:1
Local	Commercial	0.6	6	0.8	9	0.8	8	6:1
	Intermediate	0.5	5	0.7	7	0.6	6	6:1
	Residential	0.3	3	0.4	4	0.4	4	6:1
Alleys	Commercial	0.4	4	0.6	6	0.5	5	6:1
	Intermediate	0.3	3	0.4	4	0.4	4	6:1
	Residential	0.2	2	0.3	3	0.3	3	6:1
Sidewalks	Commercial	0.9	10	1.3	14	1.2	13	3:1
	Intermediate	0.6	6	0.8	9	0.8	8	4:1
	Residential	0.3	3	0.4	4	0.4	4	6:1
Pedestrian Ways and Bike Ways		1.4	15	2.0	22	1.8	19	3:1
Rest Areas	Roadways	-	-	0.6 - 0.8	6 - 9	-	-	3:1 or 4:1
	Parking Areas	-	-	1.0	11	-	-	3:1 or 4:1

Notes:

1. R1 = cement/concrete
2. R2 = asphalt/gravel & R3 = asphalt/rough texture (typical highway),
3. R4 = asphalt/smooth texture

The following are roadway and walkway classifications:

Interstate and Other Freeways. A divided major highway with full control of access and no crossings at grade.

Expressways (Other Principal Arterial). A divided major arterial highway for through traffic with full or partial control of access and generally with interchanges at major crossroads. Expressways for non-commercial traffic within parks and park-like areas are generally known as parkways.

Minor Arterial. Roads linking cities and larger towns in rural areas. In urban areas, roads that link but do not penetrate neighborhoods within a community.

Collector. The distributor and collector roadways serving traffic between major and local roadways. These are roadways used mainly for traffic movements within residential, commercial, and industrial areas.

Local. Roadways used primarily for direct access to residential, commercial, industrial, or other abutting property. They do not include roadways carrying through traffic. Long local roadways will generally be divided into short sections by collector roadway systems.

Alleys. A narrow public way within a block, generally used for vehicular access to the rear of abutting properties.

Sidewalks. Paved or otherwise improved areas for pedestrian use, located within public street right of way, which also contain roadways for vehicular traffic.

Pedestrian Ways. Public sidewalks for pedestrian traffic generally not within the right-of-way for vehicular traffic roadways. Included are skywalks (pedestrian overpasses), subwalks (pedestrian tunnels), walkways giving access to park or block interiors and crossings near centers of long blocks.

Bicycle Lanes. Any facility that explicitly provides for bicycle travel.

The following are area classifications:

Commercial. That portion of a municipality in a business development where ordinarily there are large numbers of pedestrians and a heavy demand for parking space during periods of peak traffic or a sustained high pedestrian volume and a continuously heavy demand for off-street parking space during business hours. This definition applies to densely developed business areas outside of, as well as those that are within, the central part of a municipality.

Intermediate. That portion of a municipality which is outside of a downtown area but generally within the zone of influence of a business or industrial development, often characterized by a moderately heavy nighttime pedestrian traffic and a somewhat lower parking turnover than is found in a commercial area. This definition includes densely developed apartment areas, hospitals, public libraries, and neighborhood recreational centers.

Residential. A residential development, or a mixture of residential and commercial establishments, characterized by few pedestrians and a low parking demand or turnover at night. This definition includes areas with single family homes, townhouses, and/or small apartments. Regional parks, cemeteries and vacant lands are also included.

4.1.2 Design Step 2. Selection of Luminaire and Pole Equipment

Design step 2 is the selection of the luminaire and pole equipment. The following notes should be followed in this design step:

- The type of light source selected determines the lumen output, efficacy, energy requirements, lamp life, color, optical controllability, temperature sensitivity, and environmental effects. The type of light source selected in this step will, of course, affect the rest of the design process. The various light sources used in Mn/DOT roadway applications are discussed in Chapter 2.
- Determine desired pole equipment. See Chapter 2 for Mn/DOT pole equipment. If considering high mast lighting, consider sensitivity to residential area.
- Light source size and mounting height are directly related; therefore, they are selected as a combination rather than individually. Information concerning utilization of the actual light output of a given light source used in a specific luminaire at a particular mounting height can be determined from photometric data available from the various lighting equipment manufacturers. An example of one such set of data is shown in Chapter 3.
- The correct matching of mounting height with light source size should result in meeting minimum illumination and uniformity criteria set forth in the AASHTO *Roadway Lighting Design Guide* while being responsive to economic and safety criteria.

Thus far in the design process, a lamp luminaire combination has been selected and a tentative mounting height has been chosen.

4.1.3 Design Step 3. Determine Luminaire Spacing

Design Step 3 involves the selection of the lateral and longitudinal luminaire mounting dimensions.

The lateral dimension, or the distance from the roadway edge to the luminaire, is mainly governed by the need to place the luminaire over or near the roadway edge, while meeting guidelines for clear zone. Safety considerations and right-of-way restrictions require the use of various length mast arms in order to correctly locate the luminaire support while leaving the luminaire at its desired position.

Longitudinal spacing is calculated by using the following equation:

$$\text{Luminaire Spacing} = (LL \times CU \times LLD \times LDD) / (E_h \times W)$$

Where,

LL = Initial lamp lumens

The LL is determined in Step 2 using the photometric data for the light source the designer selected.

CU = Coefficient of utilization

CU is determined using the utilization curves specific to the source and roadway characteristics. See chapter 3 for an example.

LLD = Lamp lumen depreciation factor

LLD for Mn/DOT design is 0.90.

LDD = Luminaire dirt depreciation factor

LDD for Mn/DOT design is 0.90.

Eh = Average maintained level of illumination

Eh is determined in Step 1 from the table in section 4.1.1.3.

W = Width of lighted roadway

W is determined from the curb to curb or pavement edge to pavement edge lateral distance of the roadway.

As this formula is usable in both the U.S. and the SI system of measures, either units can be used. The resultant luminaire spacing will be obtained in units corresponding to the system units used.

Luminaire Spacing Example

The following example calculates the maximum luminaire spacing given the following conditions:

- LL = 27,500
- CU = 0.26
- LLD = 0.90
- LDD = 0.90
- Eh = 0.60
- W = 36

Using the equation above,

$$\begin{aligned}\text{Spacing} &= (LL \times CU \times LLD \times LDD) / (Eh \times W) \\ &= (27,500 \times 0.26 \times 0.90 \times 0.90) / (0.60 \times 36) \\ &= 268 \text{ feet}\end{aligned}$$

The maximum spacing would be approximately 270 feet.

The following graphics are taken from the Mn/DOT Traffic Engineering Manual (TEM) and illustrate guidelines for the placement of luminaires at common geometric situations.

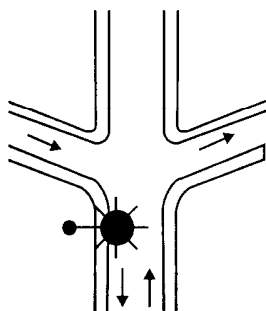
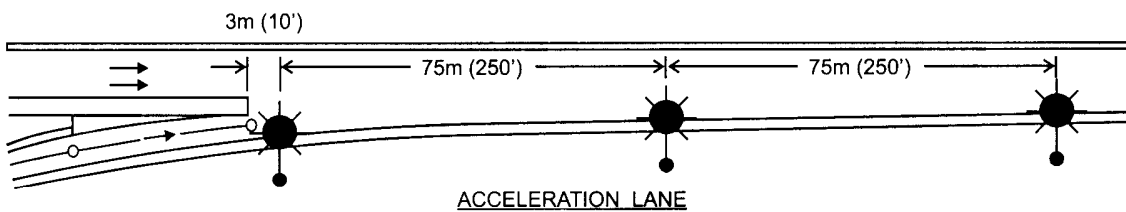
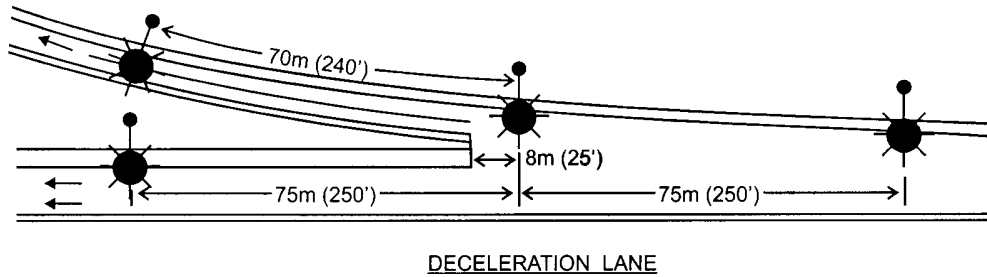

SIMPLE CROSSROAD-
RAMP TERMINALS

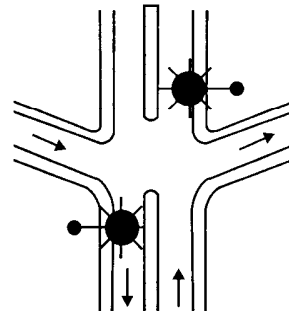

DIVIDED CROSSROAD-
RAMP TERMINALS

Typical Luminaire Locations for Partial Interchange Lighting with Davit Arm Poles

Assumes: 40' mounting height, 250w HPS, Cobra Head System

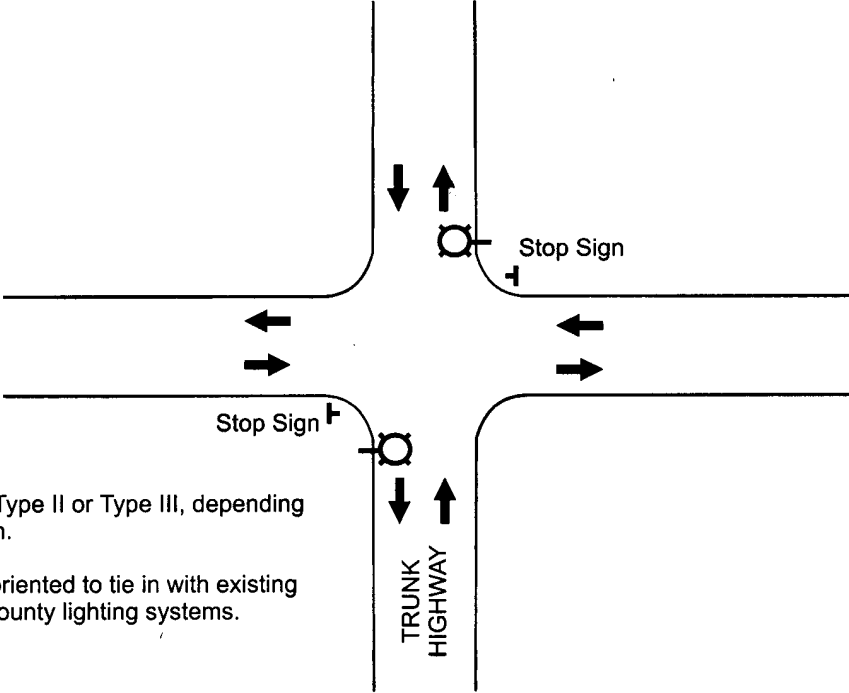

NOTE:
Luminaires shall be Type II or Type III, depending on the roadway width.
Luminaires may be oriented to tie in with existing or proposed city or county lighting systems.

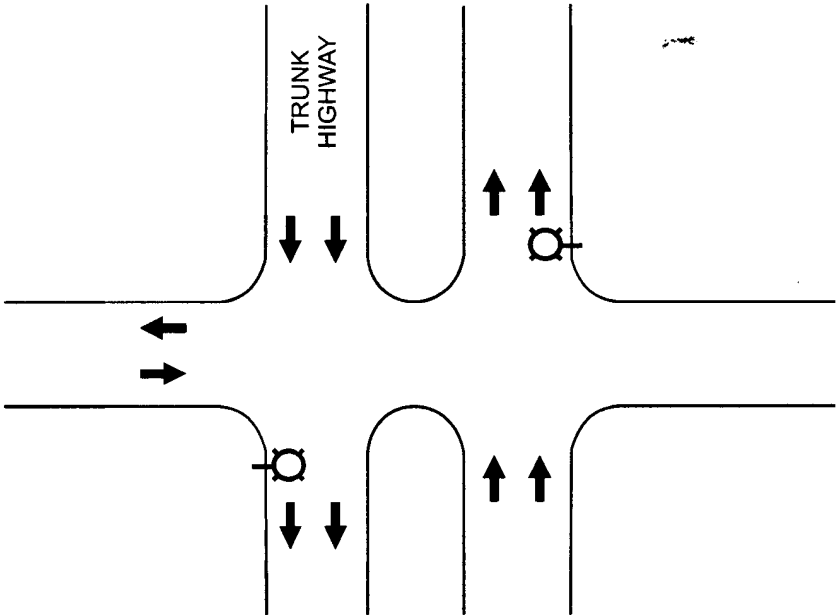

Standard Illumination Plan for Intersections

4.1.4 Design Step 4. Check Design Accuracy

The luminaire spacing equation as defined in the previous design step is based on the average level of illumination or lumens per square foot on the area of roadway under consideration. This establishes the quantity of illumination. Up to this point, nothing has been calculated regarding the quality of illumination.

The uniformity ratio is used as one way of specifying the quality of lighting. For the purpose of this manual, it is defined as the average maintained illumination value divided by the minimum maintained illumination value. Because the average maintained level of illumination is already defined by the design process (E_h), the next step involves finding the minimum point of illumination.

The minimum point of illumination can be determined by inspection of the isofootcandle diagram contained in photometric data for the particular luminaire. Referring to the isofootcandle diagram in Chapter 3, the lines in this curve define the level of illumination that will occur at various mounting heights from the luminaire. Several correction factors must be applied to the values of these lines before they are in a usable form. These are summarized below:

- Correction for light source size. The values in the isofootcandle diagram are based on 1000 bare lamp lumens. Thus, for a 27,500 lumen lamp, each of the curve values would need to be multiplied by a factor of 27.5.
- Correction for mounting height. The curve values are typically shown for one mounting height. Because the level of illumination is inversely proportional to the distance from the source, correction factors are given for adapting the curve values for various mounting heights.
- Correction for maintenance factors. In the luminaire spacing equation, factors for lamp lumen depreciation (LLD) and luminaire dirt depreciation (LDD) are used to convert the initial illumination values into maintained illumination values or that which is expected to exist after the system has been operating for some period of time. Because this maintenance correction factor is used in calculating the average illumination, it must also be used in finding the value for minimum illumination.

Once it is understood how the correction factors are defined, the next step is to locate the point of minimum illumination expected to occur on the roadway. Depending on the roadway width, mounting height, type of luminaire, and mounting configuration, the minimum point will usually occur at one of several typical locations. These locations are shown in the following figure.

If vendor is creating the lighting plans, check the LLF Average and Minimum.

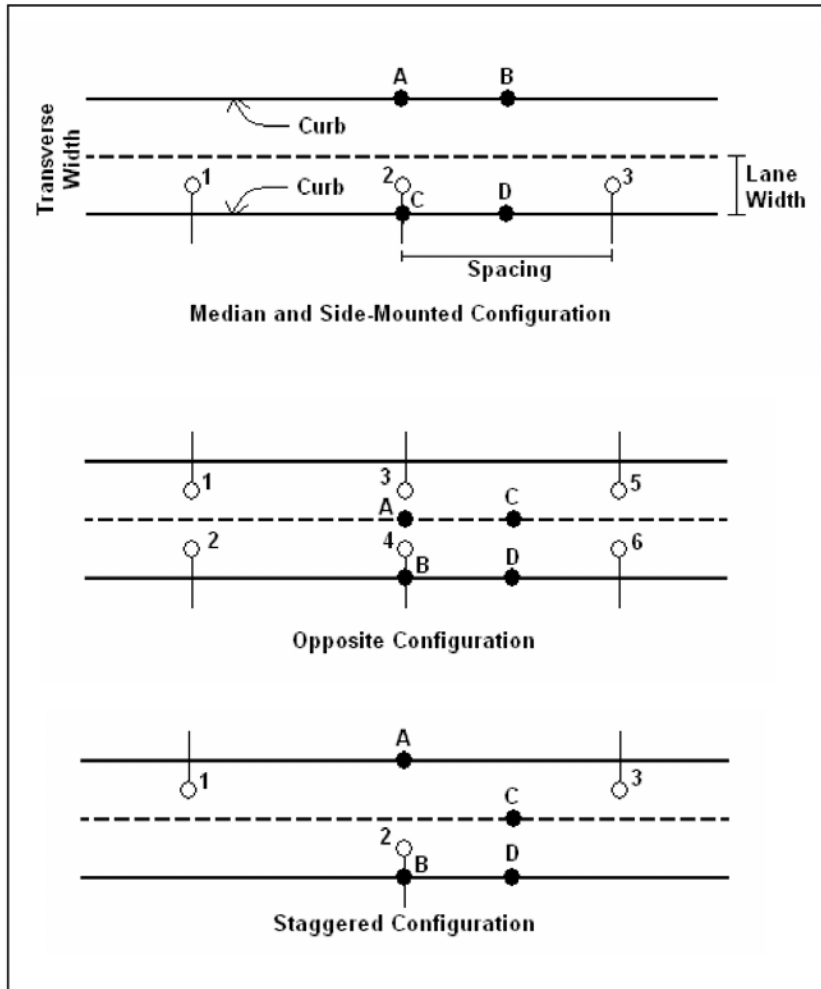

Potential Points of Minimum Illumination

After checking the illumination at each of the anticipated minimum points, the minimum illumination is used to determine the uniformity ratio. As stated above, the uniformity equation is as follows:

$$\text{Uniformity Ratio} = [\text{Average Maintained Illumination } (E_h)] / [\text{Minimum Maintained Illumination } (E_{min})]$$

where,

E_h is determined from the AASHTO *Roadway Lighting Design Guide* Table 3-5.

$$E_{min} = (LL/1000) * LLD * LDD * CF * E_{min}$$

If the Uniformity Ratio is less than the acceptable threshold for the particular area and type of roadway, the illumination design is acceptable.

Checking Design Accuracy Example

Compute the uniformity ratio at the points on the figures on the previous page (applying adjustment factors as needed). Assume the following:

- Minor Arterial – Commercial Area
- R2 – type pavement
- 250 W High Pressure Sodium Luminaires

- 40' mounting height
- 12' lane width
- Luminaires mounted over the center of lane
- Standard Mn/DOT LDD and LLD factors

Lookup or calculate the following:

- Lumens = 27,500 (see Appendix F)
- LLD = 0.90 (Mn/DOT standard value)
- LDD = 0.90 (Mn/DOT standard value)
- Correction Factor (CF) = 1.00 (photometric data in Appx. F is for 40' MH)
- Uncorrected illuminance at each point in the figure (see chart below)

	Luminaire 1			Luminaire 2			Luminaire 3			Luminaire 4			Luminaire 5			Luminaire 6		
	r _L ⁽¹⁾	r _T ⁽²⁾	E' ⁽³⁾	r _L	r _T	E'	r _L	r _T	E'	r _L	r _T	E'	r _L	r _T	E'	r _L	r _T	E'
Median and Side-Mounted Configuration																		
A	6.0	0.45	0.000	0	0.45	0.030	6	0.45	0.000	-	-	-	-	-	-	-	-	-
B	9.0	0.45	0.000	3	0.45	0.009	3	0.45	0.009	-	-	-	-	-	-	-	-	-
C	6.0	-0.15	0.000	0	-0.15	0.030	6	-0.15	0.000	-	-	-	-	-	-	-	-	-
D	9.0	-0.15	0.000	3	-0.15	0.005	3	-0.15	0.005	-	-	-	-	-	-	-	-	-
Opposite Config.																		
A	6.0	0.15	0.000	6	0.15	0.000	0	0.15	0.030	0	0.15	0.030	6	0.15	0.000	6	0.15	0.000
B	9.0	0.45	0.000	6	-0.15	0.000	0	0.45	0.030	0	-0.15	0.030	6	0.45	0.000	6	-0.15	0.000
C	6.0	0.15	0.000	9	0.15	0.000	3	0.15	0.009	3	0.15	0.009	3	0.15	0.009	3	0.15	0.009
D	9.0	0.45	0.000	9	-0.15	0.000	3	0.45	0.009	3	-0.15	0.005	3	0.45	0.009	3	-0.15	0.005
Staggered Config.																		
A	6.0	-0.15	0.000	0	0.45	0.030	6	-0.15	0.000	-	-	-	-	-	-	-	-	-
B	6.0	0.45	0.000	0	-0.15	0.030	6	0.45	0.000	-	-	-	-	-	-	-	-	-
C	9.0	0.15	0.000	3	0.15	0.009	3	0.15	0.009	-	-	-	-	-	-	-	-	-
D	9.0	0.45	0.000	3	-0.15	0.005	3	0.45	0.009	-	-	-	-	-	-	-	-	-

	Total E' ⁽⁴⁾	E _h ⁽⁵⁾	E ⁽⁶⁾	Unif Ratio ⁽⁷⁾	MaxUnif Ratio ⁽⁸⁾	OK? ⁽⁹⁾
Median and Side-Mounted Configuration						
A	0.030	1.4	0.594	2.36	4.00	Yes
B	0.019	1.4	0.374	3.74	4.00	Yes
C	0.030	1.4	0.594	2.36	4.00	Yes
D	0.011	1.4	0.214	6.55	4.00	No
Opposite Configuration						
A	0.060	1.4	1.188	1.18	4.00	Yes
B	0.060	1.4	1.188	1.18	4.00	Yes
C	0.038	1.4	0.748	1.87	4.00	Yes
D	0.029	1.4	0.580	2.41	4.00	Yes
Staggered Configuration						
A	0.030	1.4	0.594	2.36	4.00	Yes
B	0.030	1.4	0.594	2.36	4.00	Yes
C	0.019	1.4	0.374	3.74	4.00	Yes
D	0.015	1.4	0.294	4.76	4.00	No

Notes:

- (1) r_L = Longitudinal Ratio = Distance Along Street / Mounting Height
- (2) r_T = Transverse Ratio = Distance Across Street / Mounting Height
- (3) E' = Uncorrected Illuminance (fc) from chart in Appx F (negligible if 0)
- (4) Total E' = sum of E' for all luminaires
- (5) E_h = Average Maintained Illuminance from AASHTO Table 3-5
- (6) E = Maintained Illuminance (see equation on previous page)
* the smallest E is the Minimum Maintained Illuminance
- (7) Uniformity Ratio = Avg. Maint. Ill. / Min. Maint. Ill.
- (8) Max Unif Ratio - from AASHTO Table 3 - 5
- (9) OK? If (7) < (8), then Yes. All points must be yes for each configuration

If the calculated uniformity ratio (7) exceeds the maximum uniformity ratio (8), the design process should be repeated using other combinations of luminaire distributions, different mounting heights, luminaire types, and configurations. In the example above, only the opposite configuration is acceptable. The use of electronic computers in lighting design greatly speeds up this iterative process.

4.1.5 Design Step 5. Determine the Source of Power

The lighting designer must meet and discuss the source of power with the power company. Document all decisions made. Use the following checklist to determine the source of power.

4.1.5.1 Source of Power Checklist

Feed Point # _____

New Inplace

FIELD WALK / POWER COMPANY MEETING CHECKLIST

T.H. _____ at _____ Date _____

Designer _____ S.P. _____

Pwr.Co. Field Rep. Name, Telephone, Address _____

Power Company _____

Proposed Letting Date _____

* All correspondence with power company needs to be in writing.

1. TYPE OF CONSTRUCTION AND POSSIBLE IMPLICATIONS

Various types of construction:

- New lighting system
- Modification of existing system
- Replacement of existing system
- Temporary lighting system

Discuss construction staging, timeline of project and proposed letting date.

2. TYPES OF SERVICE

Use in-place service:

- Overhead or Underground
- Pole Mounted or Pad, Channel Mounted or Pad Mounted
- 120/240 Volt or 240/480 Volt

* Transformer size in KVA

Install new service:

- Temporary service needed for staging
- Permanent service
- Overhead or Underground
- Pole Mounted or Pad: Channel Mounted or Pad Mounted (preferred)
- 120/240 Volt or 240/480 Volt (preferred), (discuss transformer needs)

* Transformer size in KVA

3. DEFINE WHO IS RESPONSIBLE FOR CONSTRUCTION/MAINTAINENCE OF VARIOUS PARTS OF INSTALLATION

Knockdowns _____ Underground Cable/Conduit _____

4. LOCATION OF SERVICE – TOPOGRAPHY OF AREA

Describe quadrant and define approx. location of transformer/pole/pad (face door away from road).

Metered or Unmetered

Agency paying power costs decides – refer to power co. policy.

Document all decisions in writing with the appropriate agency.

* if local utility that doesn't meter your power, this must be addressed in the special provisions.

5. SIGNALS

Is signal system involved w/project? If so, coordinate activities:

In Duluth

TMC Cameras

ANTICIPATED LIGHTING SYSTEM LOAD: _____ Amps

Identify size of conductors (#2, #6, #0, etc) needed for power to SOP: _____

6. METER ADDRESS / OR TRANSFORMER # : _____

Confirm with letter to power company.

Billing Address: _____

7. AGENCY RESPONSIBLE FOR PAYING MONTHLY POWER COSTS:

Document all decisions in writing with the appropriate agency.

8. AGENCY RESPONSIBLE FOR PAYING MONTHLY POWER COSTS FOR TEMPORARY LIGHTING:

Document all decisions in writing with the appropriate agency.

9. ANY ADDITIONAL COSTS OR CONNECTION CHARGES TO BE CHARGED BY POWER COMPANY

(CONTRACTOR TO GET ESTIMATE):

Document all decisions in writing with the appropriate agency.

4.1.5.2 Source of Power Notes

The following notes correspond with each numbered item in the Source of Power Checklist in the section above.

1. If major roadway construction is involved, utility lines may need to be relocated. This can affect the location of a combined signal and lighting pad (SOP) for temporary lighting. When modifying a lighting system, power to all units should be maintained at all times. Also, when replacing a system, the old system must remain operational at all times.
2. In-place Service: Check condition of cabinet and pad. Additionally, check for correct voltage.
 New Service: To save installation costs, combine same location service for temporary and permanent. Have permanent cabinet installed during early stages if possible. Generally, permanent service will be pad mounted and temporary will be pole mounted.
 A 120/240 volt system is used for isolated overhead signs, city feedpoints and state feed points with few lights or when 240/480 volt system is not available. 240/480 volt system is preferable for Mn/DOT systems.
3. During construction, the contractor is responsible for all maintenance of temporary and in-place lighting until Mn/DOT has accepted the new system. After final acceptance, Mn/DOT is responsible for all maintenance on state systems (relamping may be done by utilities in some cases). On systems owned by another agency, Mn/DOT may maintain knockdowns, underground cable, or service equipment; however, this is not desirable.
4. Lighting systems are typically metered.
5. If signals are involved, a combined pad with all signal and lighting cabinets may be desirable. 240/480 volts will be needed for lighting with a step down transformer for 120/240 volt signal power. Some power companies do not allow step down transformers before their meters.
6. Mn/DOT should establish an address for the SOP and confirm this with the utility.
7. None
8. When SOP is metered, the agency who pays for power during construction should be defined. Contractors have no agreements with utilities to pay on a per light basis.
9. These costs should be shown in estimated quantities and verified by contractor.

4.1.6 Design Step 6. Lay out the Lighting System

Design Step 6 is to lay out the lighting system. During this step, utilize the pole spacing determined in Step 3, taking into account decision points such as intersections, gore areas, overhead signs (reflection issues), etc. See typical pole placement illustrations in Design Step 3 for common decision points. Also consider above and below ground utilities and overhead obstructions.

The following guidance is provided concerning exact location of lighting poles:

- The exact locations of light poles may be adjusted to avoid obstructions encountered in the field. Such items as solid rock, power lines, slopes, existing guard rail, etc., may make it necessary or desirable to locate the pole differently than is indicated in the plans.
- The project engineer may stake the poles up to 10 feet along the direction of the roadway from the locations indicated in the plans. If a greater change is required, the project engineer should consult

with the lighting system designer to determine if such a change requires changing the placement of other light poles in the system.

- For 40' poles, the plans typically place the poles 19 to 23 feet behind the edge of the traveled roadway. For 49' poles, the plans typically place the poles 33 to 36 feet behind the edge of the traveled roadway.. If this distance cannot be achieved, contact the State Lighting Engineer.
- If a guardrail or noise wall exists at the location and is not indicated in the plans, light poles should be placed behind it if possible. Clearance between the back of the guardrail and the front of the light pole should be at least 2 feet.
- Poles should not be closer than 20 feet in any direction from power lines. If 20 feet cannot be maintained, contact the power company.
- Poles should not be closer than 25 to 50 feet in any direction from overhead signs.
- Poles should not be placed in ditches for maintenance reasons.

4.1.7 Design Step 7. Lay Out Wiring and Conduit System

The following notes are used in Design Step 7, which is laying out the wiring and conduit system:

- Mn/DOT typically uses 4/C #4 Direct Buried Armored Cable.
- Use 3" Rigid Non-Metallic Conduit (NMC) Schedule 80 under traveled roadways.
- Use 1½ RSC for bridges, retaining walls, and Jersey barriers with 1/C #4 wire.
- 1½ " Non-Metallic Conduit (NMC) allowed in median barriers.
- Determine the conduit requirements based on the current wiring configuration.
- Follow 40 percent fill rule for conduit requirements where required.
- Determine service cabinet based on lighting system requirements.

The figures below illustrate typical conduit placement for cloverleaf and diamond interchanges.

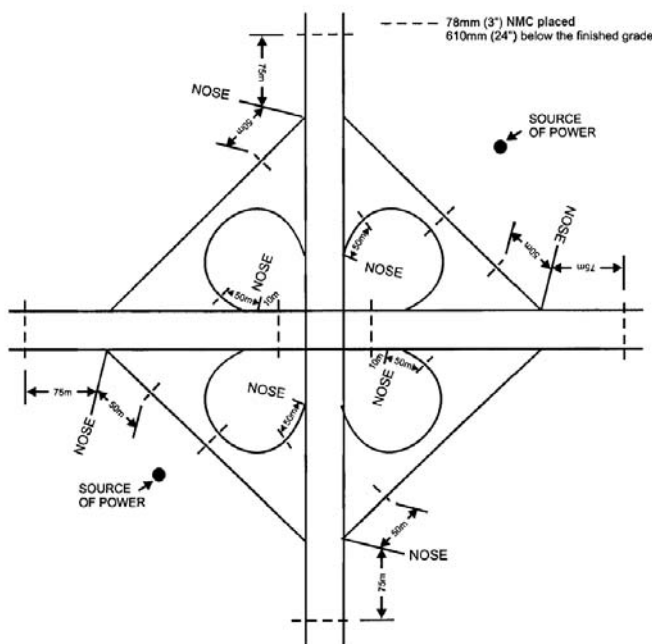

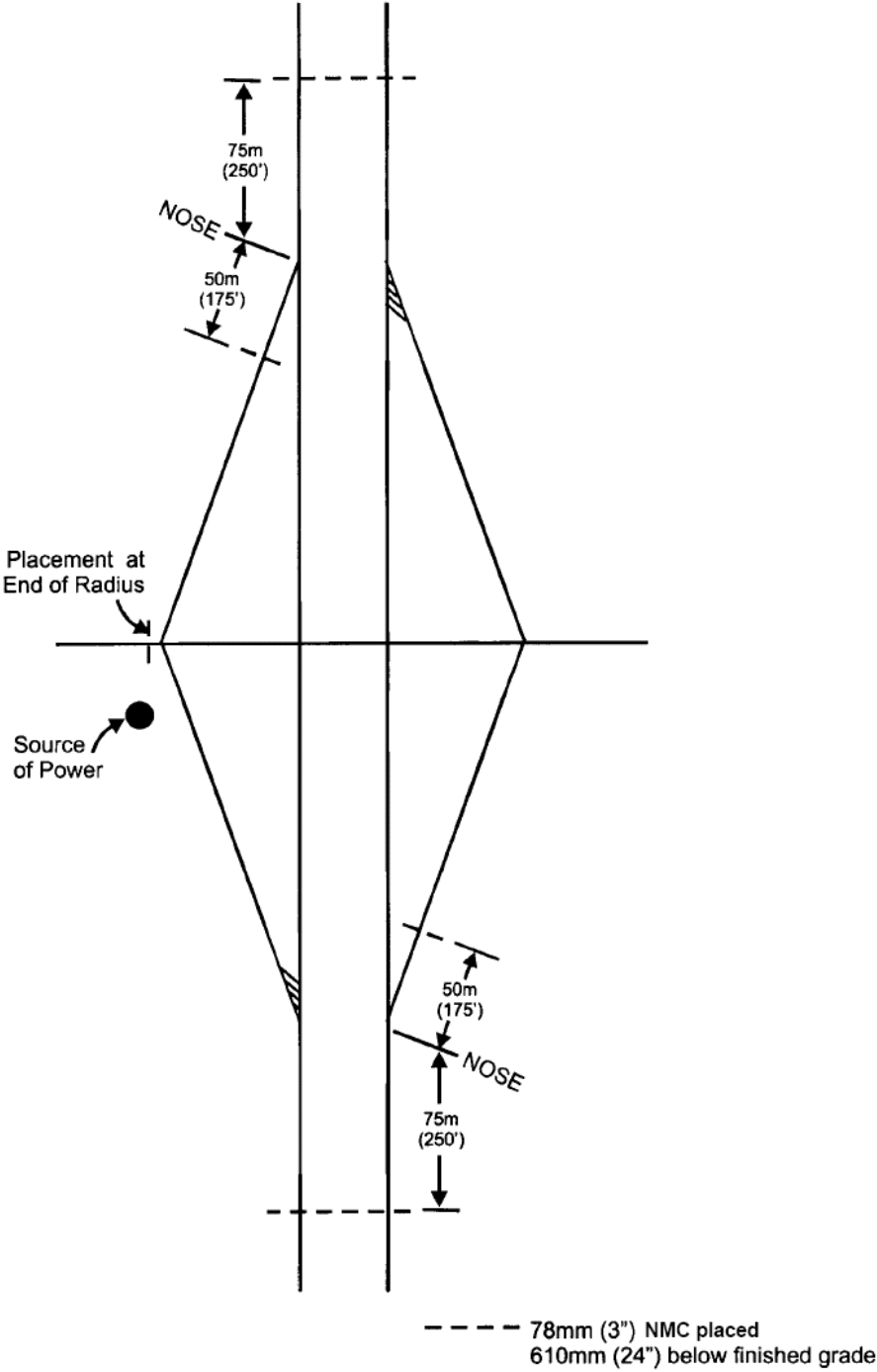

Typical Conduit Placement for Diamond Interchanges

4.1.8 Design Step 8. Calculate Voltage Drops

To determine the correct electrical components, a voltage drop calculation should be conducted. A voltage drop calculation shows the amount of voltage that will be present at the farthest luminaire on a lighting branch circuit. The voltage drop is of concern in order to assure that the voltage at all luminaires will be sufficient for the luminaires to operate properly, and also to avoid inefficient operation of the lighting system due to a large amount of power being dissipated in the electrical distribution system (wires).

The wires carrying current to the luminaires in the lighting system have a small amount of resistance. The resistance of the wire depends on the size (gauge) of the wire, the material of the wire, and the length of the wire. When current flows through the wires on its way to the luminaires, a voltage proportional to the resistance and to the current is developed along the length of the wire. This voltage subtracts from the voltage at the source of power and results in a lower voltage at the luminaires. If the resistance of the wire is too high for the amount of current flowing through it, the voltage dropped along the wire will be too high to allow sufficient voltage at the luminaires. The National Electrical Code suggests a value of three percent of the system voltage to be a reasonable limit to the amount of voltage drop to allow in the lighting branch circuit. The voltage along the wire multiplied by the current flowing through the wire yields the power dissipated in the wire. The higher the resistance of the wire, the higher the voltage dropped along the wire, and the more power is used up by the wiring system. The voltage drop calculation determines the size (gauge) of wire of a specified material that is necessary to carry the required current the required distance without creating too large of a loss in the wire.

The following equation, known as Ohm's Law, is used to determine the voltage drop in a lighting branch circuit:

$$E = I \times R$$

E = voltage drop along a segment of wire

I = current through the same length of wire

R = resistance of the length of wire

Notes regarding the use of Ohm's Law are as follows:

- This equation is only completely accurate for direct current systems. With the current in the branch circuits limited to 20 amperes by the circuit breakers, and the frequency of the power at 60hz, the equation is fairly accurate for the lighting branch circuits also.
- E is the unknown value that is sought.
- I for any segment of wire is calculated by adding the currents for each luminaire the particular segment of wire feeds (i.e. all the luminaires downstream on that wire).
- R for a particular segment of wire is calculated by multiplying the length of the wire (in thousands of feet) in that segment by the resistance per 1000 foot of wire for that particular size and material of wire.
- The total voltage drop to the farthest luminaire is calculated by adding the voltage drops for each segment of wire from the service cabinet to that luminaire.
- The current for a single luminaire of various types and the resistance values for several types of wire are summarized in the tables below.

Current in Amps for High Pressure Sodium Luminaires

Luminaire Voltage	Lamp Wattage			
	150	200	250	400
120	1.7	2.1	2.9	4.1
240	0.9	1.1	1.4	2.1

Current in Amps for Metal Halide Luminaires

Luminaire Voltage	Lamp Wattage		
	175	250	400
120	1.8	2.6	4.1
240	0.9	1.3	2.1

Resistance of Conductors in Ohms per 1000 Feet

Conductor Material	Conductor Size (AWG)							
	12	10	8	6	4	2	0	00
Copper	1.62	1.018	0.6404	0.410	0.259	0.162	0.102	0.0811

The voltage drop must be calculated for the phase wire (hot wire, ungrounded wire) and for the neutral wire (grounded wire), and these voltages must be added together to arrive at the total voltage drop. In a two-wire circuit, the current that travels out in the phase wire must return in the neutral, and so the current in the neutral wire is the same as the current in the phase wire. The total voltage drop in the two-wire circuit, then, can be calculated by figuring the voltage drop in just the phase wire and multiplying that number by two.

Most of the lighting branch circuits in lighting systems designed by the state are three-wire single phase circuits. A three-wire circuit consists of two phase wires and a neutral wire instead of one phase wire and one neutral wire as in the two-wire circuit. In a three-wire circuit, the neutral is at approximately zero volts with respect to the ground. The two phase wires share the same neutral and are at opposite voltages with respect to the neutral wire. For example, if at some given time the voltage in one phase wire was 240 volts with respect to the neutral wire, then the voltage in the other phase wire at that same time would be 240 volts with respect to the neutral wire. The significance of this voltage arrangement is that the current returning in the neutral wire from one of the phase wires will cancel out the current returning in the neutral wire from the other phase wire. Thus, if the loads on the two phase wires are exactly balanced, there will be no current in the neutral wire, and no voltage drop in the neutral wire. In this case, the total voltage drop to the farthest luminaire is simply the total voltage drop in the phase wire, and the neutral wire can be disregarded.

Two examples of a voltage drop calculation are shown below. One example is for single luminaires wired to alternate phase wires as is typically done. The second example is for double luminaire poles which might be found on a median barrier. Two different voltages are used in the examples to illustrate the application of the voltage drop at different voltages.

Voltage Drop Example One: Single Luminaires

The system in this example is as follows:

- 250 watt high pressure sodium luminaires with
- 130 foot spacing between poles
- The wires are number 4 gauge single conductor wires in a conduit system
- 120/240 volt lighting system
- There are 9 lights total on the lighting branch circuit, with the lights wired to alternate phase wires. A circuit such as this might be found in a downtown city street light system.
- A wiring diagram for the lighting branch circuit is shown below. The wire segment labels and the distances between the lights are also shown on the diagram.

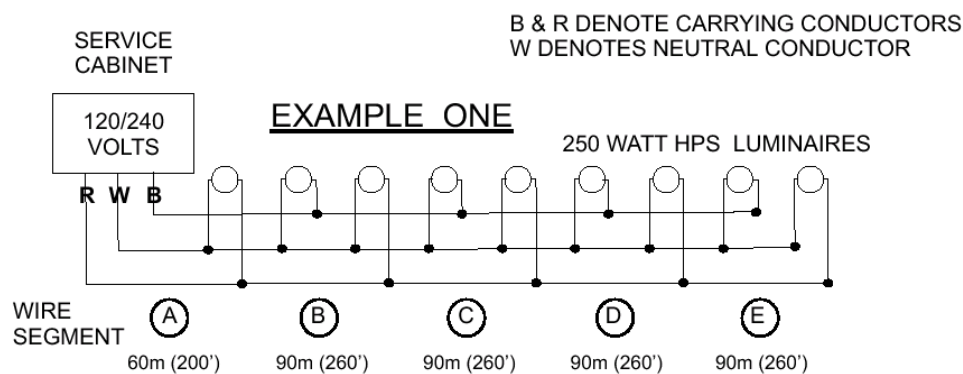

The following is looked up or calculated to solve the example:

- From the appropriate current table, the current for a 250 watt high pressure sodium luminaire at 120 volts is 2.9 amperes.
- The resistance for number 4 gauge copper wire is 0.259 ohms per 1000 feet.
- The following table calculates the voltage drop in the phase wire for each wire segment and gives the total voltage drop. Notes regarding completion of the table are as follows:
 - The distance is a given from the layout of the system.
 - The resistance is calculated by multiplying the distance in thousands of feet by the resistance per thousand feet.
 - The current is calculated by multiplying the number of luminaires downstream of each wire segment by 2.9 amperes per luminaire.
 - The voltage drop in each segment of wire is calculated by multiplying the current in each wire segment by the resistance of each wire segment.
 - The total voltage drop is calculated by adding the voltage drops of all the wire segments.

Wire Segment	Distance, feet	Resistance, ohms	Current, amps	Voltage Drop, volts
A	200	0.0518	14.5	0.7511
B	260	0.06734	11.6	0.7811
C	260	0.06734	8.7	0.5858
D	260	0.06734	5.8	0.3905
E	260	0.06734	2.9	0.1952
Total				2.704

The current in the neutral wire is disregarded for this calculation. Depending on the system layout, the voltage drop in the neutral may add to the total voltage drop or subtract from the total voltage drop as calculated. The contribution of the voltage drop in the neutral wire is negligible compared to the voltage drop in the phase wire if the system is reasonably balanced.

Since 3 percent of 120 volts is 3.6 volts, this value is acceptable, and the number 4 wires can be used.

Had number 6 gauge wires been used, the resistance would be 0.410 ohms per 1000 feet and the voltage drop would have been 4.2805 volts. This is more than 3 percent of 120 volts, and so number 6 gauge wires are too small.

The calculation would be identical if four conductor number 4 armored cable were used instead of the single conductor number 4 gauge wires.

Voltage Drop Example Two: Double Luminaires

The system in this example consists of the following:

- 250 watt high pressure sodium luminaires
- Poles are 240 feet apart with two luminaires on each pole
- The wires are number 4 gauge single conductor wires in a conduit system
- 240/480 volt lighting system
- There are 16 lights total on the lighting branch circuit, with one light wired to each phase wire at each pole. A circuit such as this might be found in the median of a freeway.
- A wiring diagram for the lighting branch circuit is shown below. The wire segment labels and the distances between the lights are also shown on the diagram.

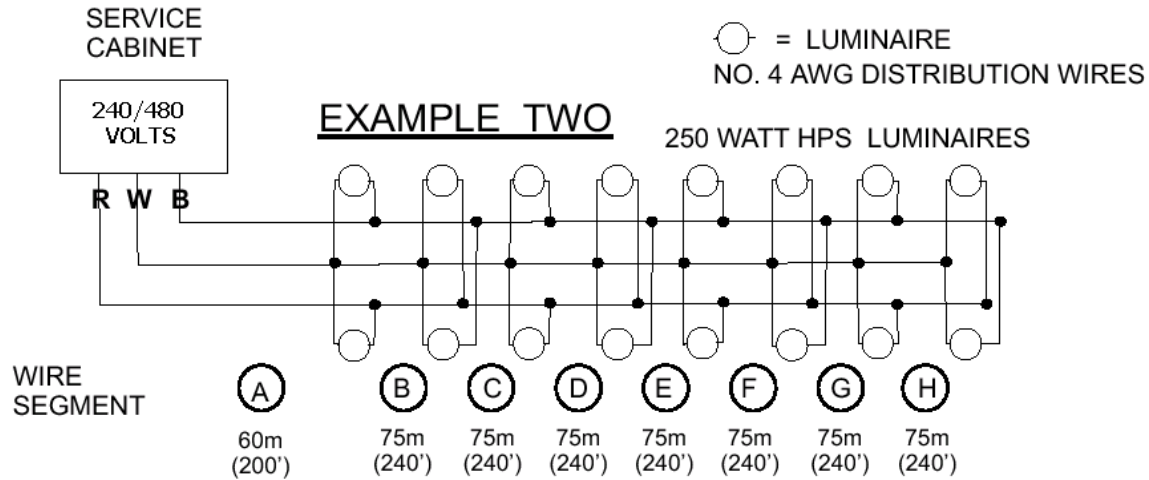

The following is looked up or calculated to solve the example:

- From the appropriate current table, the current for a 250 watt high pressure sodium luminaire at 240 volts is 1.4 amperes.
- The resistance for number 4 gauge copper wire is 0.259 ohms per 1000 feet.
- The following table calculates the voltage drop in the phase wire for each wire segment and gives the total voltage drop. The voltage drop in each segment of wire is calculated in the same manner as in Example One.

Wire Segment	Distance, feet	Resistance, ohms	Current, amps	Voltage Drop, volts
A	200	0.05180	11.2	0.5802
B	240	0.06216	9.8	0.6092
C	240	0.06216	8.4	0.5221
D	240	0.06216	7.0	0.4351
E	240	0.06216	5.6	0.3481
F	240	0.06216	4.2	0.2611
G	240	0.06216	2.8	0.1740
H	240	0.06216	1.4	0.0870
Total				3.0168

- The current in the neutral wire is disregarded for this calculation. If only double luminaire poles are on the branch circuit, the load is exactly balanced at all points on the circuit, there is no current anywhere in the neutral, and the voltage drop is correct as calculated.
- Since 3 percent of 240 volts is 7.2 volts, this value is acceptable, and the number 4 wires can be used.

4.1.9 Design Step 9. Iterate Steps 7 and 8

Perform special wire sizing (if required) and conduit requirements based on voltage drop limitations. Continue until a viable wiring system and conduit layout is achieved.

4.1.10 Design Step 10. Complete Wiring Diagram, Service Cabinet, and Number Poles

Design Step 10 involves completing the wiring diagram, service cabinet, and numbering poles. Locate the service cabinet with considerations for the following:

- Maintenance (Can a vehicle get to the location? Can all the lights be seen from the cabinet?)
- Place outside the clear zone
- Place approximately equidistant to all wiring to minimize voltage drops

4.1.11 Design Step 11. Determine Salvage and Removal Items

Design Step 11 is to determine salvage and removal items. To complete this design step, obtain lighting exhibits or as built in-place plans from the lighting system owner and conduct a field review of the new system. The district lighting engineer will provide guidance on salvage items.

4.1.12 Design Step 12. Determine Temporary Lighting Needs

Generally, if the system under construction was previously continuously lit, provide temporary lighting. Temporary lighting is designed to the same standards as permanent lighting.

4.1.13 Design Step 13. Determine Quantities

In order to determine quantities, reference the most current Mn/DOT Specifications Book for a listing of standard pay items at the end of section 2545. For non-standard pay items use the following Mn/DOT website: <http://www.dot.state.mn.us/stateaid/bams-index.html>.

4.1.14 Design Step 14. Finish Plan Set Layout

Design Step 14 is finishing the plan set layout. The Lighting Unit in the Office of Traffic, Safety & Technology, the district traffic office, or consultants design the lighting system and draft the plans for lighting systems that will be installed under a state contract. A copy of the 35W plan set, which is a large lighting plan set, is located in Chapter 6 for your reference.

Standard lighting design plans shall contain at least the following sheets which are described in the following sections:

Sheet	Stand Alone Lighting Design Plan	Lighting Plan is a Component of a Larger Plan Set
Title Sheet	X	
Statement of Estimated Quantities	X	
Tabulation of Estimated Quantities		X
Details	X	X
Lighting Plan Layout	X	X
Utilities	X	*
Traffic Control Plans (High Mast Lighting only)	X	X

* Utilities would be included in the overall plan set

Final lighting plans should be prepared on 11" x 17" plan sheets. The original title sheet shall be of vellum composition. The scale for the lighting plan does not have to follow the road construction project. Each sheet of the plan must be properly identified in the lower right corner (State Project or State Aid Project Number and Sheet XX of XX Sheets).

4.1.14.1 Title Sheet

The title sheet is required for all stand alone lighting plans. The title sheet should include the title block, project location and description, the state and federal project number(s), the area and job number(s), appropriate signature lines, roadway design values, legends and symbols, a list of scales, and a plan index.

MINNESOTA DEPARTMENT OF TRANSPORTATION
CONSTRUCTION PLAN FOR REPLACEMENT OF EXISTING LIGHTING SYSTEMS
LOCATED AT THE INTERSECTION OF T.H. 65 & C.S.A.H. 10

STATE FUNDS

GOVERNING SPECIFICATIONS
THE 2005 EDITION OF THE MINNESOTA DEPARTMENT OF TRANSPORTATION 'STANDARD SPECIFICATIONS FOR CONSTRUCTION' SHALL GOVERN.

INDEX

DESCRIPTION	SHEET NO.
TITLE SHEET	1
QUANTITIES	2
DETAILS	3-6
PLAN	7-9

THIS PLAN CONTAINS 9 SHEETS

I HEREBY CERTIFY THAT THIS PLAN WAS PREPARED BY ME OR UNDER MY DIRECT SUPERVISION AND THAT I AM A DULY LICENSED PROFESSIONAL ENGINEER UNDER THE LAWS OF THE STATE OF MINNESOTA.

PRINT NAME: MICHON/SPY/STREIBY, LICENSE # 19963
 DATE: _____ SIGNATURE: _____
 DESIGN SQUAD: PAUL BARR, GREG BRANDT
 RECOMMENDED FOR APPROVAL: _____ DIRECTOR TRANSPORTATION ENGINEER _____ DATE: _____
 RECOMMENDED FOR APPROVAL: _____ DISTRICT TRAFFIC ENGINEER _____ DATE: _____
 RECOMMENDED FOR APPROVAL: _____ STATE INSPECTING ENGINEER _____ DATE: _____
 RECOMMENDED FOR APPROVAL: _____ DATE: _____
 OFFICE OF LAND MANAGEMENT APPROVAL: _____ DIRECTOR LAND MANAGEMENT _____ DATE: _____
 APPROVED: _____ STATE DESIGN ENGINEER

200'
PLAN SCALE 1"=200'
INDEX MAP NOT TO SCALE

PLAN REVISIONS		
DATE	SHEET NO.	APPROVED BY

PROJECT LOCATION
ANOKA COUNTY
METRO DISTRICT

FOR PLANS & UTILITIES SYMBOLS SEE 'TECHNICAL MANUAL'

PROJ. NO. 0207-88 CHARGE IDENTIFIER

State Project 0207-88 (T.H. 65 = 005) SHEET 1 OF 9 SHEETS

Appropriate symbols are contained in the Mn/DOT Road Design "Technical Manual".

For Mn/DOT Lighting Unit designed stand alone lighting projects, the title sheet is signed by the designer (a licensed professional engineer), but all subsequent sheets utilize an electronic signature block. If the lighting plan set is part of a larger plan set, a signature block similar to the following is required on all lighting plan sheets.

I hereby certify that sheets ___ to ___ have been prepared by me or under my direct supervision and I am a duly licensed professional engineer under the laws of the State of Minnesota.

JOE DESIGNER

Date _____ LIC. NO. 12345

When a municipality is participating in the cost for installing or maintaining the lighting system, the title sheet should include a signature line for the appropriate authority from the municipality. The District Traffic Engineer should submit a final copy of the plan to the municipality for review and approval before the project is let.

4.1.14.2 Quantity Sheet

Also included in the lighting plans should be a statement of estimated quantities, or tabulation of quantities if part of a larger project. It is sometimes desirable to include provisions for conduit, hand holes, and junction boxes as part of the roadway project and to have the rest of the lighting plan as a separate project.

Normally, the lighting system pay items are itemized showing items for conduit, cable, light standards, etc. Any notes pertaining to any of the items in the estimated quantities should be included on the estimated quantities sheet. If a lighting system is paid for as a lump sum, the plans could include a tabulation of the individual items that are part of the lump sum.

The URL for Mn/DOT standard plates is:

<http://standardplates.dot.state.mn.us/StdPlate.aspx>

<p><u>UTILITIES</u></p> <p>NO UTILITIES WILL BE AFFECTED BY THIS PROJECT</p> <p>PRIOR TO ANY EXCAVATION WORK, THE CONTRACTOR IS HEREBY REMINDED OF HIS RESPONSIBILITY UNDER MINNESOTA STATUTE 2160 AND RULES CHAPTER 7560 TO CONTACT GOPHER STATE ONE-CALL FOR THE LOCATION OF UNDERGROUND UTILITIES (FACILITIES).</p> <p>Access communications, Incorporated AT & T Corp. CenterPoint Energy Resources Corp., d/b/a CenterPoint Energy Minnesota Gas City of Blaine City of Spring Lake Park Comcast Cable Communications, Incorporated Connexus Energy Minnesota Dept. of Transportation Owest Corporation Spring Lake Park Schools Xcel Energy</p> <p>NOTE: THE SUBSURFACE UTILITY INFORMATION IS UTILITY QUALITY LEVEL D. THIS UTILITY QUALITY LEVEL WAS DETERMINED ACCORDING TO THE THE GUIDELINES OF CI/ASCE 38-02, ENTITLED "STANDARD GUIDELINES FOR THE COLLECTION AND DEPICTION OF EXISTING SUBSURFACE UTILITY DATA". ALL WORK IS WITHIN MN/DOT RIGHT OF WAY</p>		<p>THE FOLLOWING STANDARD PLATES APPROVED BY THE DEPT. OF TRANSPORTATION AND THE FEDERAL HIGHWAY ADMINISTRATION SHALL APPLY ON THIS PROJECT.</p> <table border="1" style="width: 100%; border-collapse: collapse;"> <thead> <tr> <th colspan="2">STANDARD PLATES</th> </tr> <tr> <th>PLATE NO.</th> <th>DESCRIPTION</th> </tr> </thead> <tbody> <tr> <td>B1808</td> <td>EQUIPMENT PAD B</td> </tr> <tr> <td>B144A</td> <td>P.V.C. HANDHOLE/COLLAR</td> </tr> <tr> <td>B127B</td> <td>LIGHT RACE SECTION E</td> </tr> </tbody> </table> <table border="1" style="width: 100%; border-collapse: collapse;"> <thead> <tr> <th colspan="4">STATEMENT OF ESTIMATED QUANTITIES</th> </tr> <tr> <th>ITEM NO.</th> <th>ITEM</th> <th>UNIT</th> <th>S.P. 0207-88 ESTIMATED QUANTITIES</th> </tr> </thead> <tbody> <tr> <td>2545-503</td> <td>ELECTRIC LIGHT SYSTEM</td> <td>LUMP SUM</td> <td>1</td> </tr> </tbody> </table>	STANDARD PLATES		PLATE NO.	DESCRIPTION	B1808	EQUIPMENT PAD B	B144A	P.V.C. HANDHOLE/COLLAR	B127B	LIGHT RACE SECTION E	STATEMENT OF ESTIMATED QUANTITIES				ITEM NO.	ITEM	UNIT	S.P. 0207-88 ESTIMATED QUANTITIES	2545-503	ELECTRIC LIGHT SYSTEM	LUMP SUM	1
STANDARD PLATES																								
PLATE NO.	DESCRIPTION																							
B1808	EQUIPMENT PAD B																							
B144A	P.V.C. HANDHOLE/COLLAR																							
B127B	LIGHT RACE SECTION E																							
STATEMENT OF ESTIMATED QUANTITIES																								
ITEM NO.	ITEM	UNIT	S.P. 0207-88 ESTIMATED QUANTITIES																					
2545-503	ELECTRIC LIGHT SYSTEM	LUMP SUM	1																					
BY DATE REVISIONS LOCATION: C5-AJH-10		<p>LIGHTING QUANTITIES</p>																						
DRAWN BY: DS	CHK BY: GS	DATE:	CERTIFIED BY: <i>Michael P. LeBeau</i> LICENSE NUMBER: _____ LIC. NO. 19883 DATE: 11/25/2008																					
		STATE PROJ. NO. 0207-88 (T.H. 65) SHEET NO. 2 OF 9 SHEETS																						

THIS SHEET
FOR FINAL DESIGN INFORMATION ONLY

ESTIMATED QUANTITIES			
ITEM NO.	ITEM	UNIT	S.P. 0207-88
			ESTIMATED QUANTITIES
2021.501	MOBILIZATION	LUMP SUM	1
2104.501	REMOVE CONDUIT SYSTEM	LIN. FT.	100
2104.509	REMOVE LIGHTING UNIT	EACH	50
2104.509	REMOVE LIGHT FIXTURE	EACH	2
2104.509	REMOVE LIGHT STANDARD BASE	EACH	48
2104.509	REMOVE EQUIPMENT PAD	EACH	2
2104.509	REMOVE SERVICE EQUIPMENT	EACH	1
2104.509	REMOVE HANDHOLE	EACH	4
2104.523	SALVAGE SERVICE CABINET	EACH	2
2545.511	LIGHTING UNIT TYPE 6B-40	EACH	2
2545.511	LIGHTING UNIT TYPE 9-40	EACH	46
2545.514	UNDERPASS LIGHTING FIXTURE TYPE L	EACH	2
2545.515	LIGHT BASE DESIGN E	EACH	46
2545.521	1" RIGID STEEL CONDUIT	LIN. FT.	80
2545.521	2" RIGID STEEL CONDUIT	LIN. FT.	300
2545.523	3" NON-METALLIC CONDUIT (DIRECTIONAL BORE)	LIN. FT.	930
2545.523	4" NON-METALLIC CONDUIT (DIRECTIONAL BORE)	LIN. FT.	30
2545.531	UNDERGROUND WIRE 1 COND NO 2	LIN. FT.	900
2545.531	UNDERGROUND WIRE 1 COND NO 4	LIN. FT.	1500
2545.531	UNDERGROUND WIRE 1 COND NO 10	LIN. FT.	240
2545.533	ARMORED CABLE 4 COND NO 4	LIN. FT.	11,250
2545.541	SERVICE CABINET SECONDARY TYPE L1	EACH	2
2545.545	EQUIPMENT PAD B	EACH	2
2545.551	JUNCTION BOX (LIGHTING)	EACH	1
2545.553	HANDHOLE	EACH	5
2545.603	.75" LIQUIDTIGHT FLEXIBLE CONDUIT	LIN. FT.	10
2563.601	TRAFFIC CONTROL	LUMP SUM	1

NO SHEET # THIS PAGE

BY	DATE	REVISIONS

LIGHTING QUANTITIES	
STATE PROJ. NO. 0207-88 (T.H.65)	NO SHEET # THIS PAGE

The following is a list of standard lighting pay items:

Item No.	Item	Unit
2104.509	Remove _____	Each
2104.523	Salvage _____	Each
2545.501	Electric Light System	Lump sum
2545.503	Electric Power System	Lump sum
2545.509	Conduit System	Lump sum
2545.511	Lighting Unit, Type _____	Each
2545.513	Luminaire	Each
2545.514	Underpass Lighting Fixture, Type _____	Each
2545.515	Light Base, Design _____	Each
2545.521	____" Rigid Steel conduit	Linear Foot
2545.522	____"Intermediate Metal Conduit	Linear Foot
2545.523	____"Nonmetallic conduit	Linear Foot
2545.531	Underground Wire, ____ Conductor No.	Linear Foot

Item No.	Item	Unit
2545.533	Armored Cable, ___ Conductor No.	Linear Foot
2545.541	Service Cabinet, Secondary Type _____	Each
2545.545	Equipment Pad _____	Each
2545.551 (update number)	Junction Box	Each
2545.553	Hand Hole	Each
2545.602	Service Equipment	Each
2545.602	Electrical Service	Each
2545.602	Install _____	Each

Hints for estimating cable/conduit quantities:

1. Conduit/Conductors: 30' (9 m) up pole to pole mounted transformer.
2. Armored Cable: 5' (1.5 m) in base, 5' (1.5 m) out of base
 - o [10 feet (3 m) at each base in a run]
 - o [5 feet (1.5 m) at the base at end of a run]
3. Underground Conductors: 20 (6.1 m) feet in base 20 (6.1 m) feet out of base
4. Measure underground wire or armored cable and add 5 percent, then apply steps 2 and/or 3.
5. Measure overhead cable and add 15 percent.

4.1.14.3 Detail Sheets

Detail sheets should show details for each type of pole and luminaires used in the project, details for mounting the service panels and photoelectric controls, any special anchorage details, conduit attachment to bridges for underpass lighting, and any other necessary details.

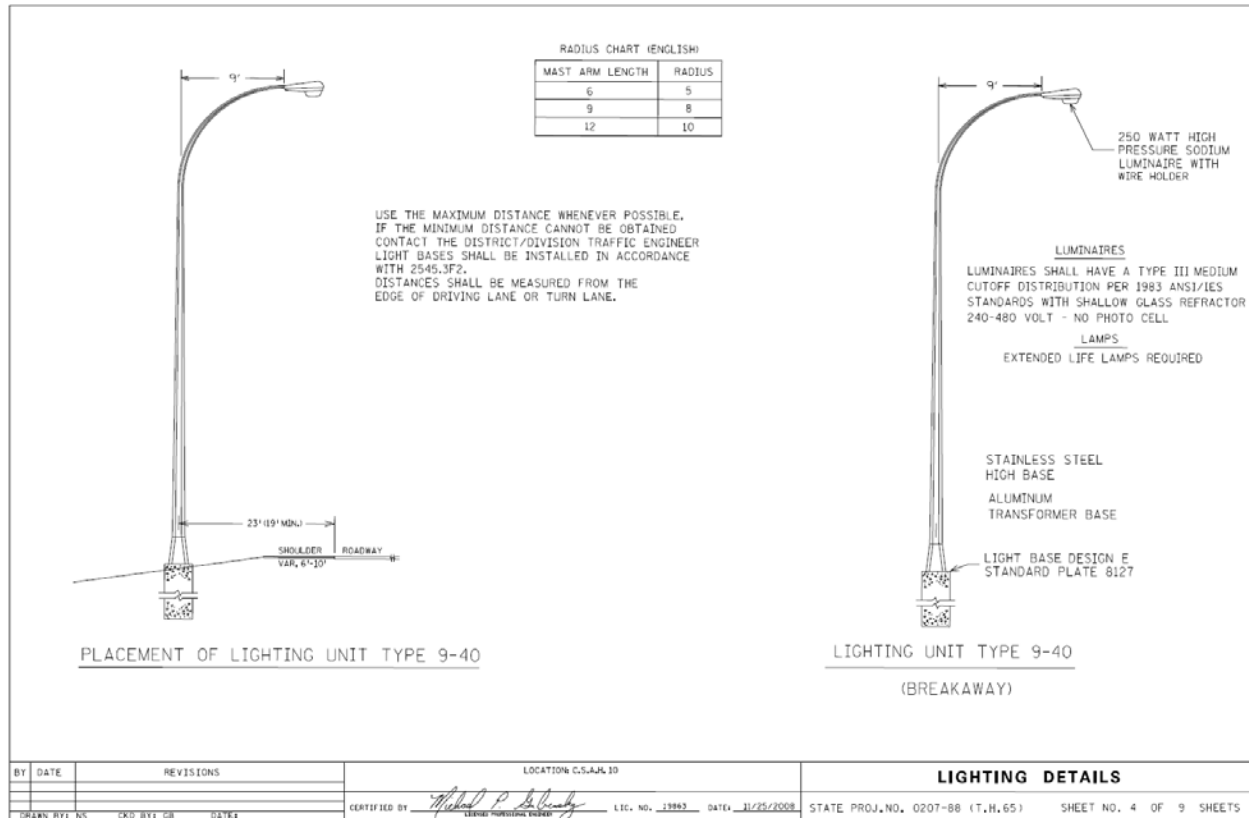

4.1.14.4 Pole Layout Sheet

Each pole layout sheet should include a layout of the roadway and locations of light standards, cable, service cabinets, conduit, junction boxes, and hand holes. All of these items should be properly labeled and identified. A tabulation should list stations, locations, and types of lighting units.

On the first layout sheet, a legend and symbols should be shown. Appropriate symbols are contained in the Mn/DOT road design "Technical Manual." All layout sheet must reference the sheet number that the legend appears on.

All luminaires and sign lights indicated in the plans should be labeled with a unique number. Numbers for roadway, tunnel, and underpass luminaires should consist of the feedpoint number above a number indicating the luminaire on that feedpoint. The luminaires should be numbered consecutively. Sign light numbers should consist of the feedpoint number above a letter indicating the sign light on that feedpoint and should be numbered from left to right separately for signs facing each direction of travel on the roadway.

A Light Standards and Bases summary table should be included on the pole layout sheet. See the sample plans below.

T.H. 65 and C.S.A.H. 10 Sample Plan (see Tab 6 for full size plan)

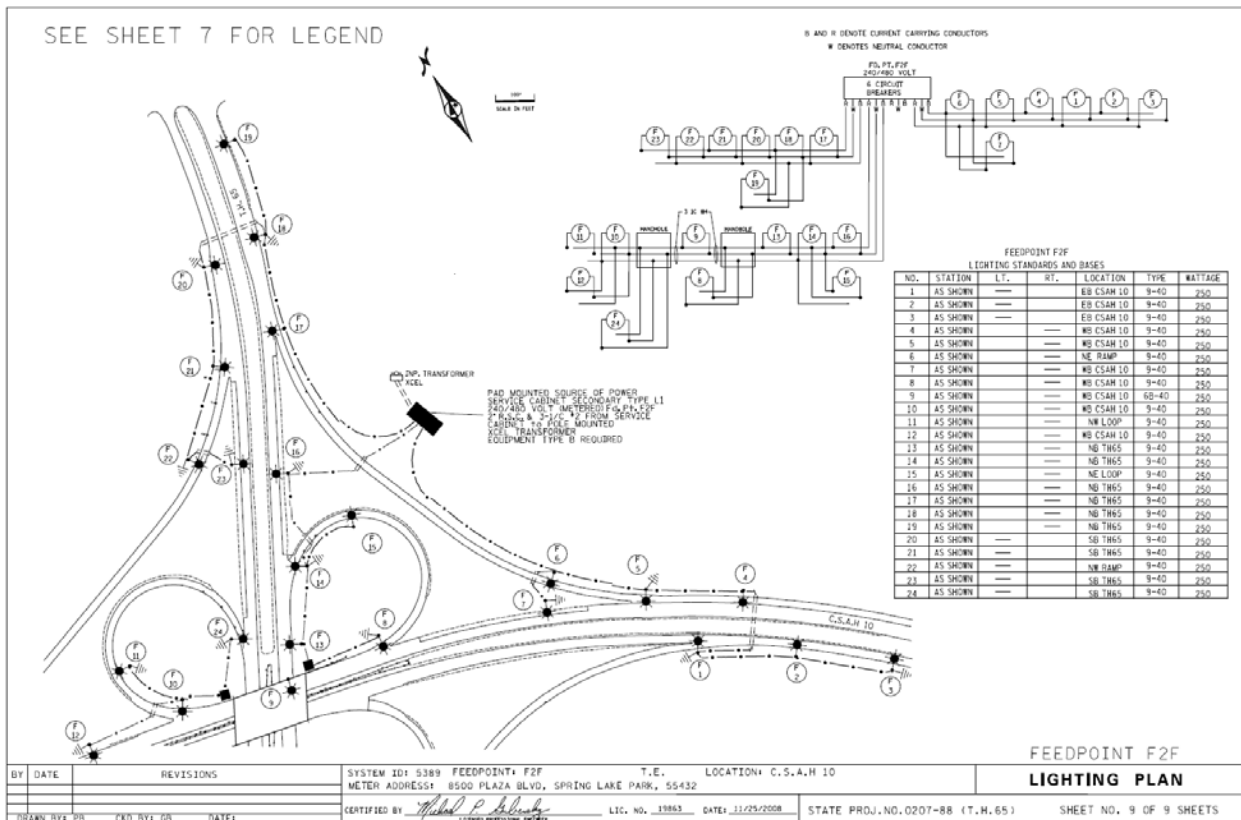
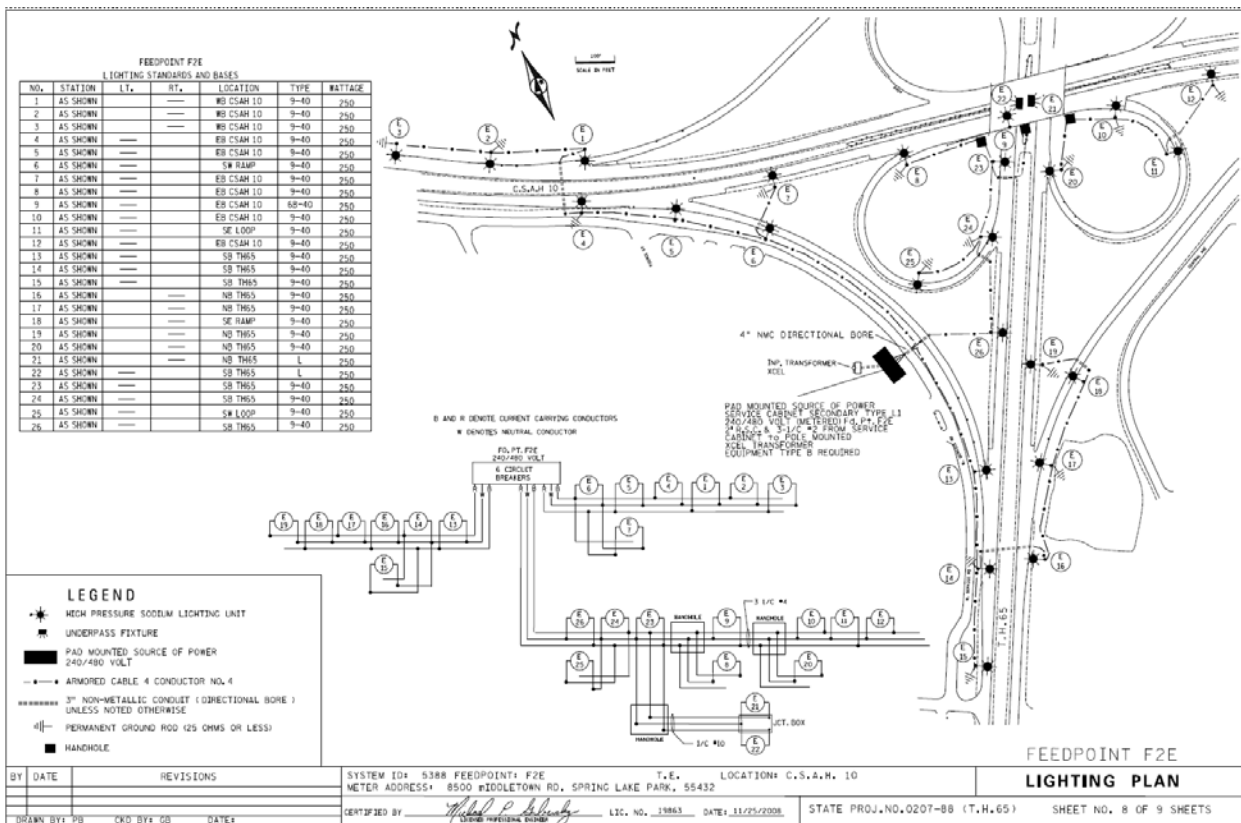

T.H. 23 Sample Plan Set (see Tab 6 for full size plan)

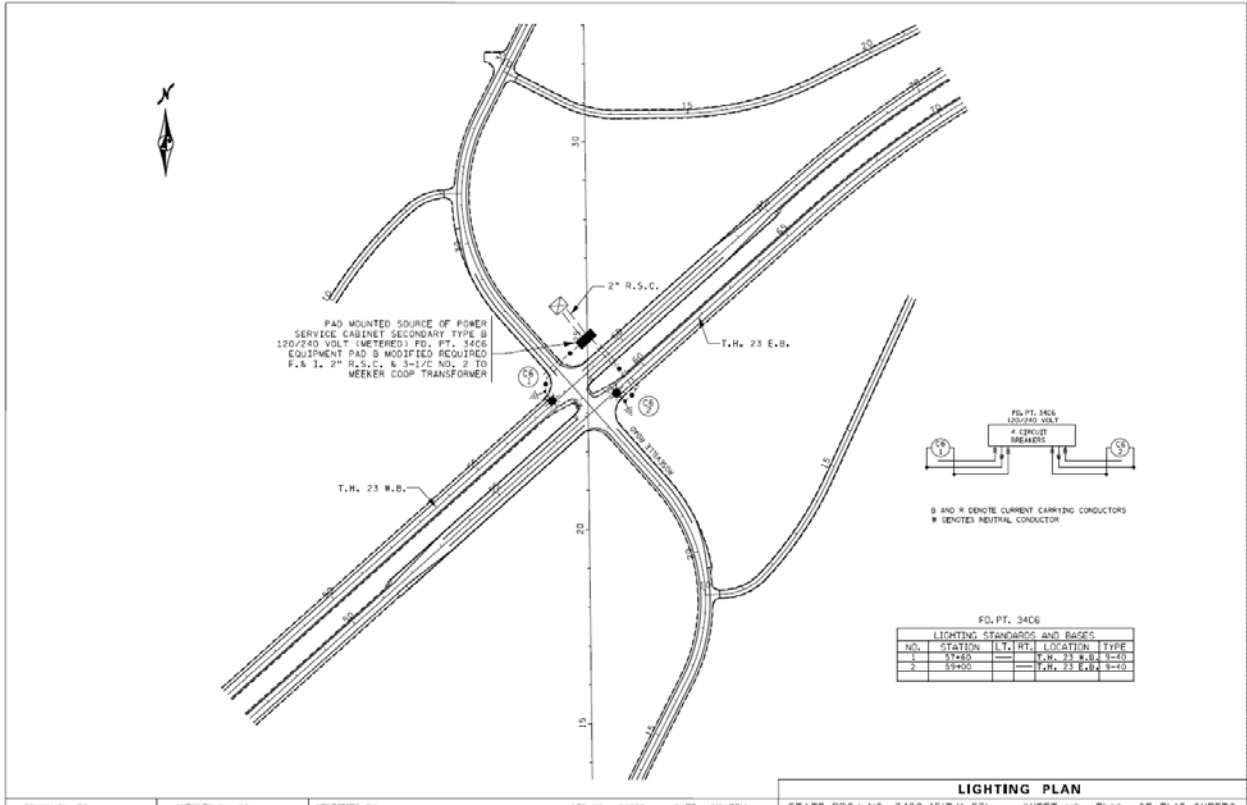
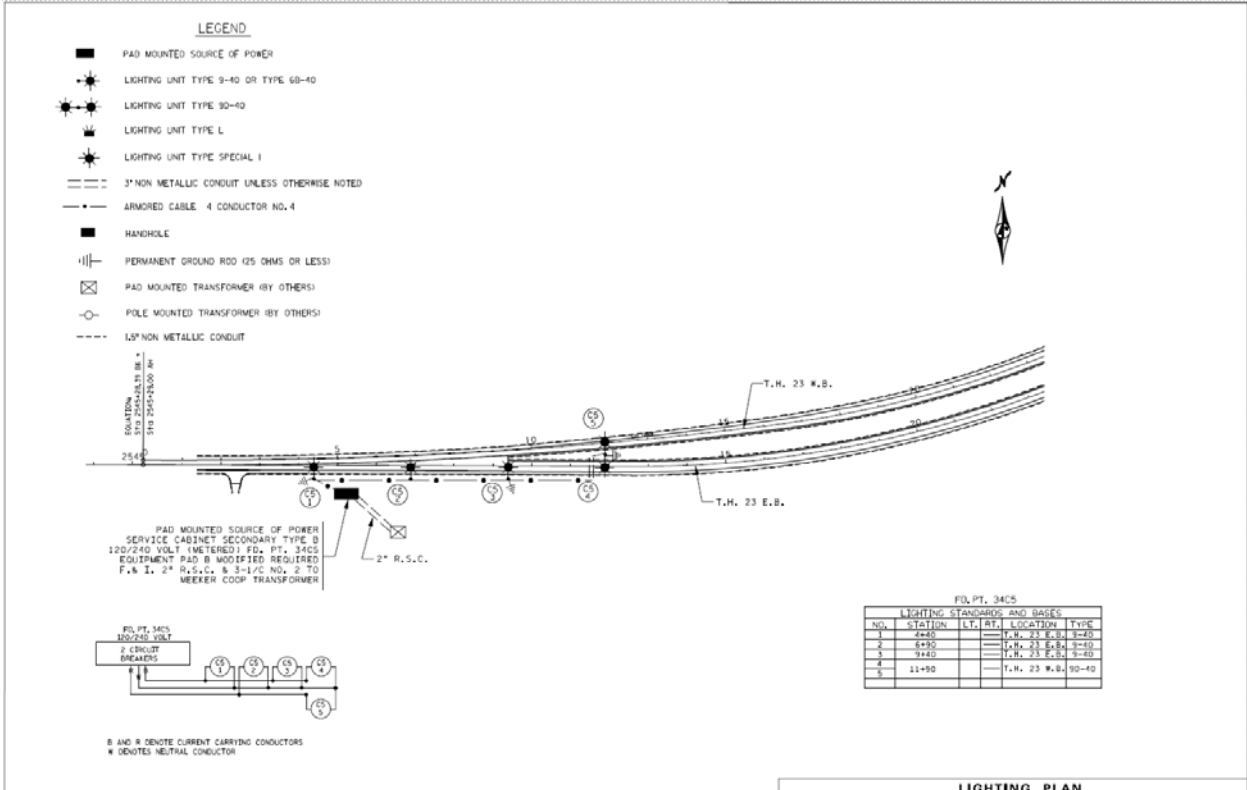

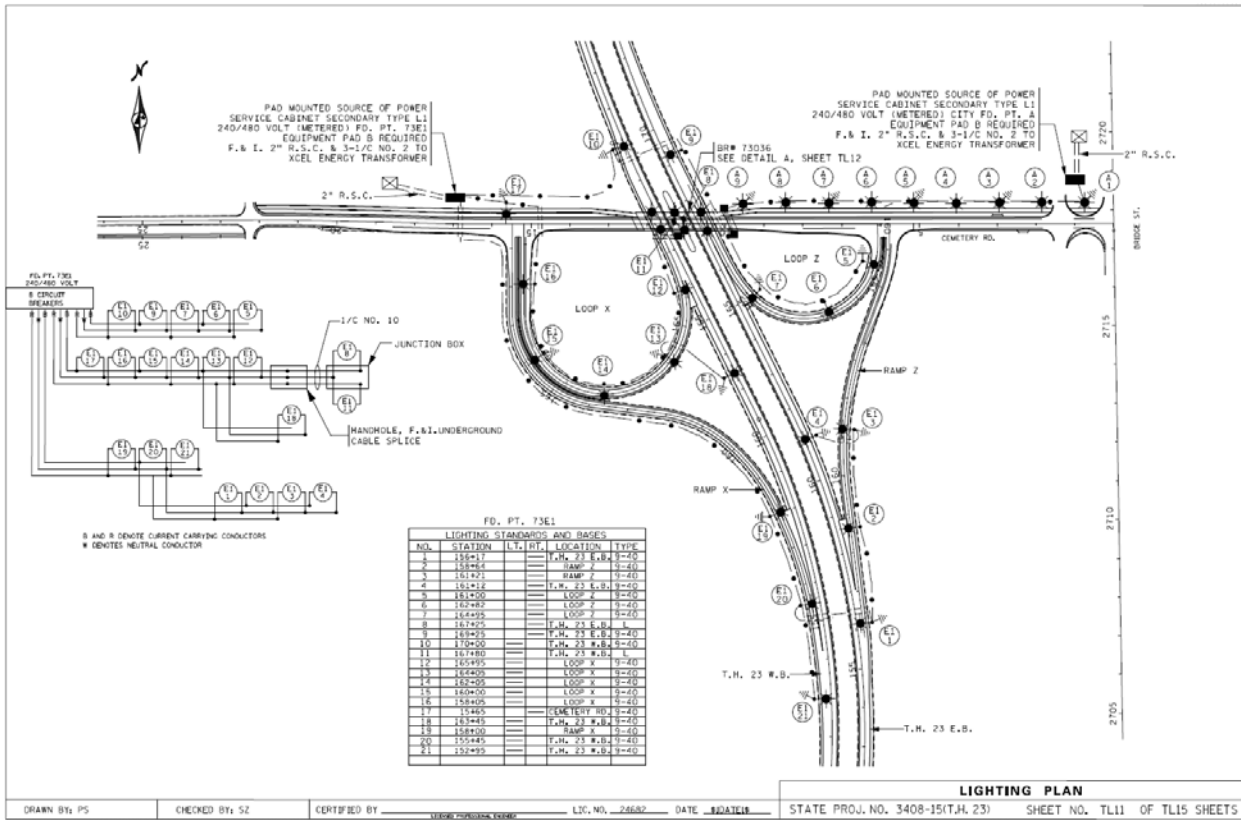

DRAWN BY: PS CHECKED BY: SZ CERTIFIED BY: _____ LIC. NO. 24652 DATE: 03/24/10 STATE PROJ. NO. 3408-15(T.H. 23) SHEET NO. TL11 OF TL15 SHEETS

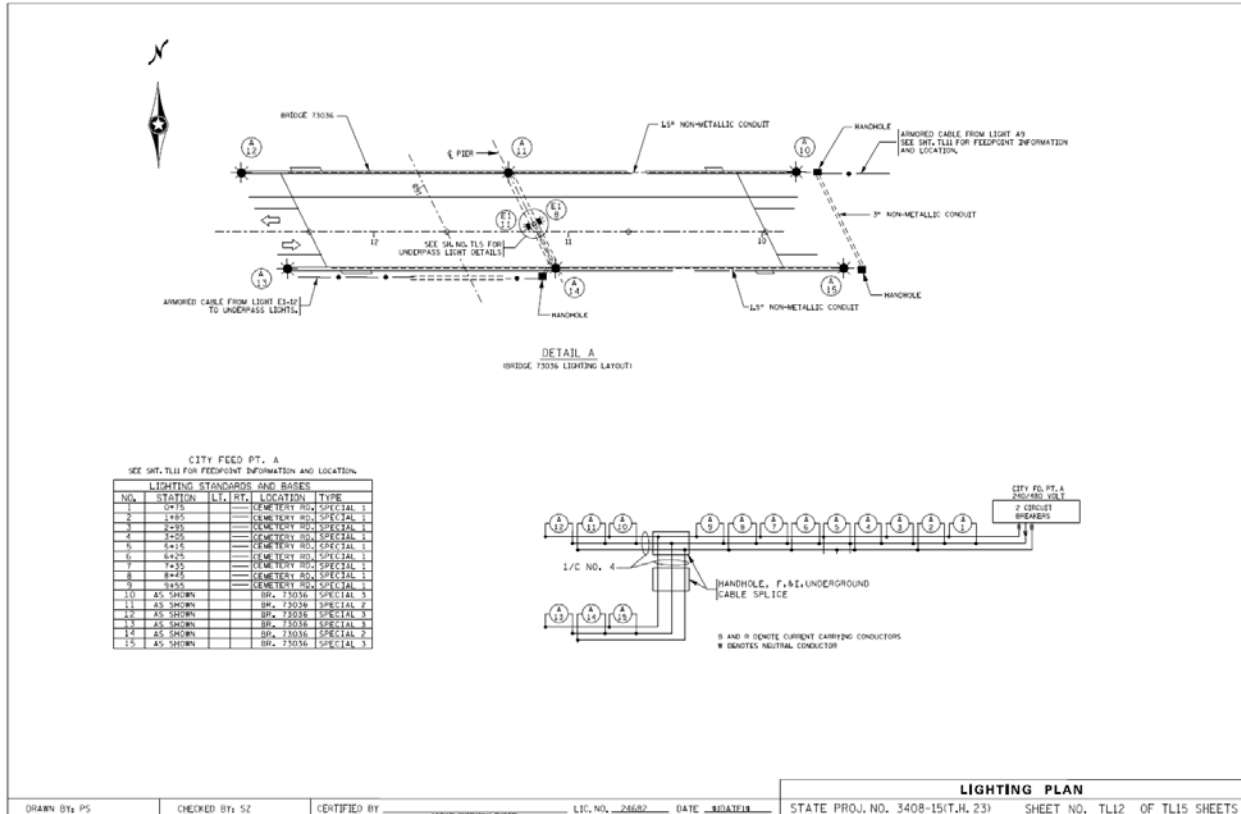

DRAWN BY: PS CHECKED BY: SZ CERTIFIED BY: _____ LIC. NO. 24652 DATE: 03/24/10 STATE PROJ. NO. 3408-15(T.H. 23) SHEET NO. TL12 OF TL15 SHEETS

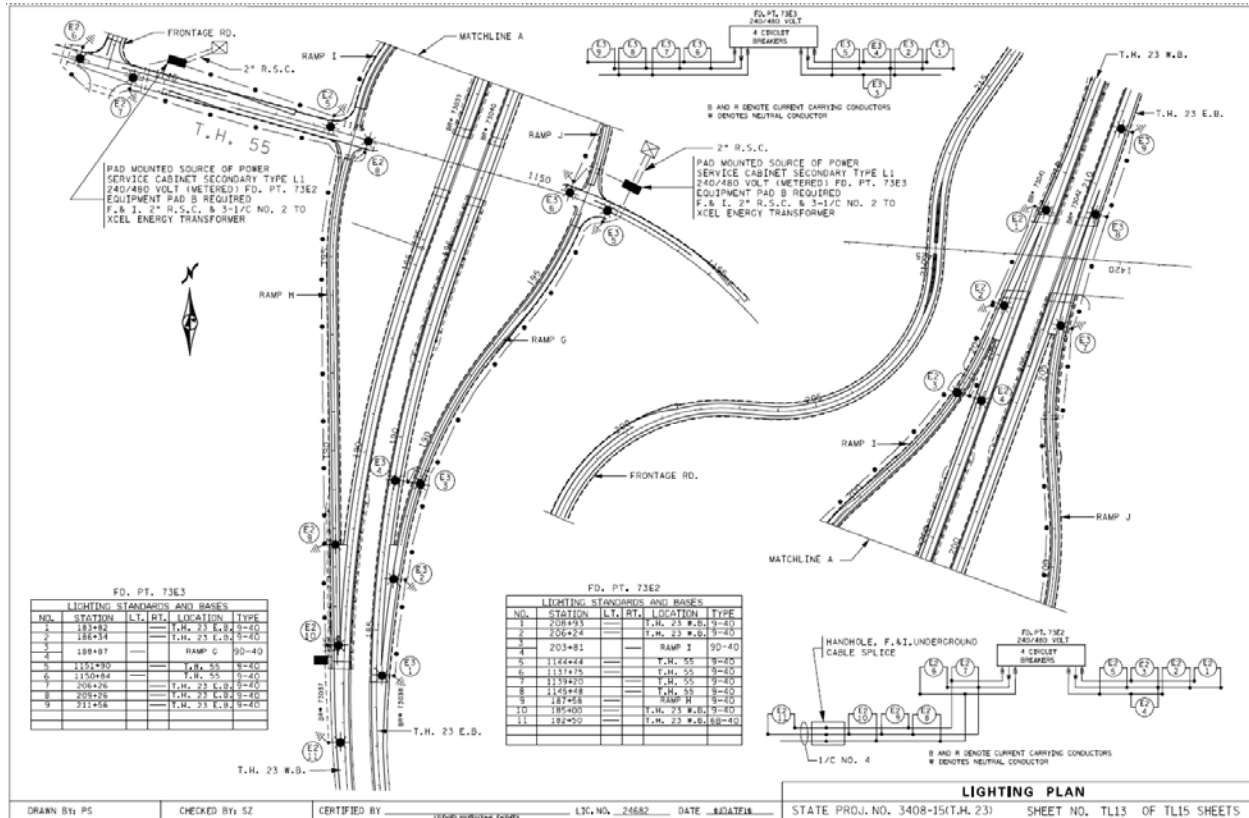

Wiring

The plans should include wiring diagrams to detail the wiring of the lighting circuits and to show wire sizes. Information sheets should be included when appropriate. Contact must be made with the appropriate power company to establish source of power(s). The power company may require extra equipment and have an electrical service charge. All communications with the power company shall be confirmed in writing.

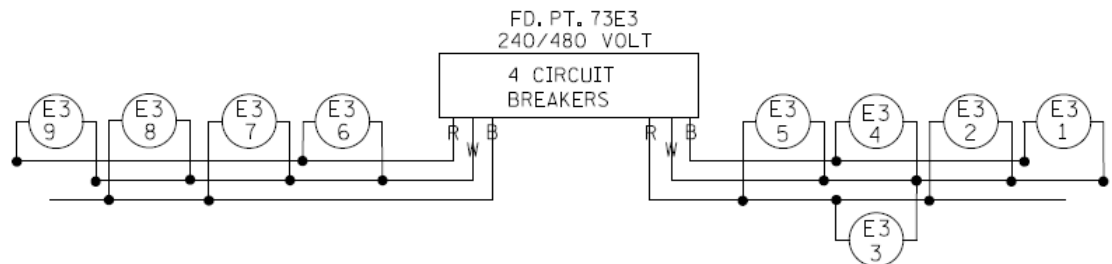

4.1.14.5 Utilities Sheet

This sheet details the utilities within the lighting plan area. Typical notes included on the utilities sheet are:

- It shall be the contractor’s responsibility to utilize the Gopher One Call Excavation Notice System (phone # 651-454-0002), required by Minnesota Statute 2160 for all utility locations.
- No utilities will be affected by this project (if appropriate).

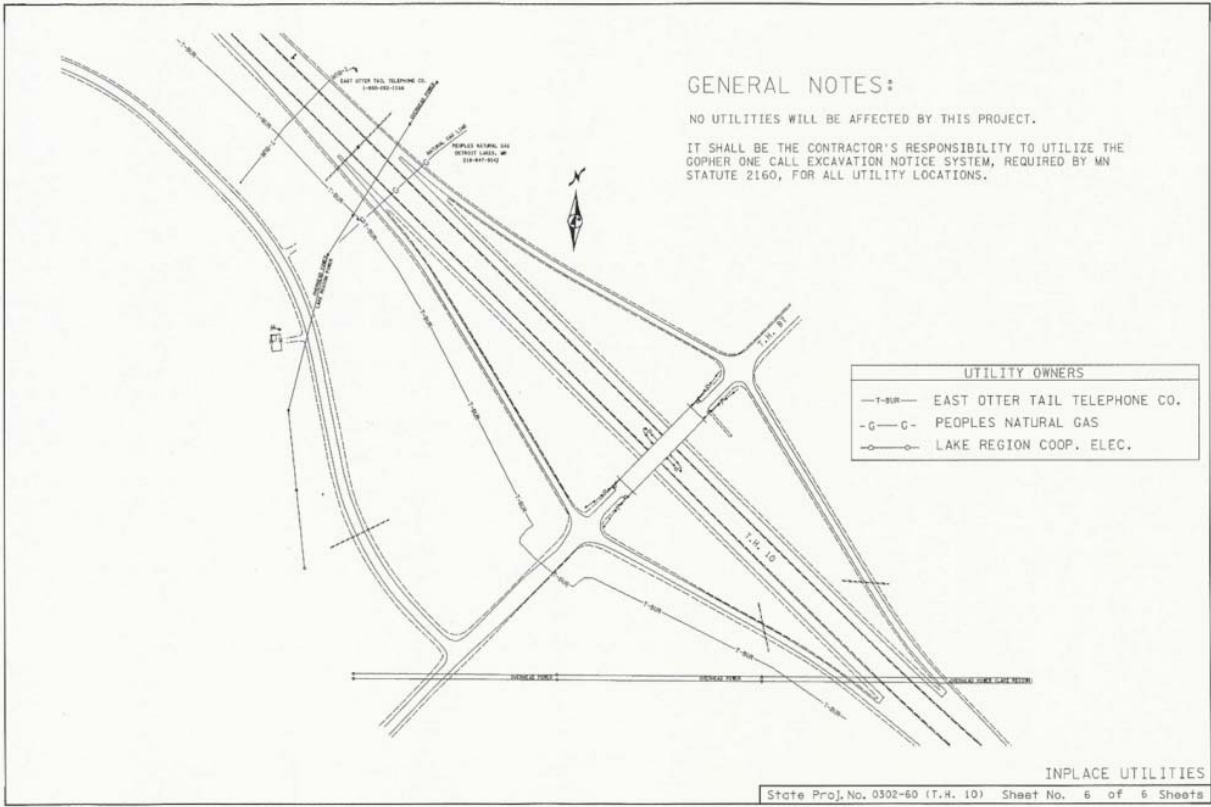

(Note: this plan is not part of the sample plan set)

4.2 Sample Letters

This section contains sample letters that may need to be written during the roadway lighting design process.

Shown below is a sample letter for a utility location survey:

	Minnesota Department of Transportation
	Office of Traffic Engineering Mail Stop 725 1500 West County Road B2, Suite 250 Roseville, MN 55113
	Office Tel: (612) 582-1095 Fax: (612) 582-1033
 August 19, 1998	
To:	Name Principle Land Surveyor Metro – Golden Valley
Or	Name2 Land Surveyor Metro – Oakdale
From:	Name 3 State Lighting Engineer
Subject:	Location Survey Request for S.P. XXXX-XXX T.H. XX Location Roadway Lighting Plan Proposed Letting Date
 Please conduct a utility location survey for the above mentioned roadway lighting plan on T.H. xxx from _____ to _____.	

The following is a sample memorandum for a request for soil borings and foundations (if high mast lighting is used):



**Minnesota Department of Transportation
OFFICE MEMORANDUM**

DATE: August 19, 1998

TO: Acting Foundations Engineer

FROM: State Lighting Engineer

PHONE: (612) 582-1095

SUBJECT: S.P. 2785-313, T.H. 494
East Bush Lake Rd. To E. Of T.H. 100.
Request for soil borings and foundation recommendations

We are installing high mast lights in the above mentioned area and attached are plan sheets showing the proposed locations. We are requesting foundation recommendations (type and size of pilings required) for these high mast lights. Electronic files are also available on CA64S1\pub\2785313.tow.

These plans are scheduled for a December, 1997 or January, 1998 letting.

If you have any questions, please give myself or _____ a call.

Thanks!

cc:
File

4.3 Lighting Design Computer Programs

There are many lighting software programs to use as a lighting design aid. The cost of the lighting software programs vary from free to moderately expensive. The more capabilities the program has, the higher the cost.

Free lighting software programs are manufacturer developed. These programs are usually web-based and can be obtained from the manufacturers' web site or by contacting the manufacturer directly.

Lighting software programs are either independently or manufacturer developed. A few examples are:

- Independently developed:
 - Lumen-Micro (point-by-point plus rendering)
 - Autolux (internal to ACAD)
 - AGI32 (point-by-point plus rendering) - used by Mn/DOT
 - Lightscape (rendering, CAD required)
 - Accurender (rendering, CAD required)
- Manufacturer developed:
 - Genesys II (Genlyte)
 - Lite-Pro (Columbia/LCA)
 - Luxicon (Cooper)
 - Visual (Lithonia)
 - ALADAN +Plus

4.4 Temporary Lighting

The providing of temporary lighting may be desirable in construction areas or near at-grade intersections on highways where the warrants listed previously are met. The Transportation District Engineer may request the installation of temporary lights from a power company, or the temporary lights may be installed by the contractor or state.

Lighting installed by the power company is maintained by the power company and, while it may be a power company's standard design, it must meet all of the state's safety requirements. Temporary lighting installed by the state or the contractor may be maintained by the power company, the state, or the contractor and is the state's or the contractor's design. Temporary lights in a construction zone are subject to being frequently moved, so maintenance by the contractor is often the simplest to implement in that the state and the power company do not have to keep track of which lights are where at any given time. When the contractor maintains the system, the special provisions should indicate that the contractor is also responsible for paying for the power. If temporary lighting is to be left in place at the end of a project and to be removed as part of a later project, it may be better for the state to maintain the system and pay for the power. Temporary lighting which is not part of an agreement with the power company should be metered.

Power distribution to temporary lighting units is typically by means of self-supporting ACSR messenger quadplex aluminum cable. Quadplex cable should be used to provide the two phase wires, the neutral wire, and the ACSR messenger equipment ground wire. Aluminum wire should not be used if the lighting will be in place for a long period of time.

Light units in the clear zone (30 feet from the edge of the driving lane) must be breakaway. In-place source of power and future source of power should be used when possible. Vertical mount systems with steel

bases provide the best coverage when lighting from one side. Provide continuous temporary lighting on either side of the project termini. Speed limits, alignment, width of lanes, and volumes should be considered when determining the need for temporary lighting.

5. SPECIFICATIONS AND AGREEMENTS

In this Chapter you will be introduced to specifications and agreements as related to roadway lighting design. The items covered include:

- Mn/DOT Lighting Design Standards
- Mn/DOT Specifications Book
- Special Provisions
- Agreements
- Cost Sharing Policy

This section covers standards, specifications, special provisions, agreements and cost sharing policy as each pertains to lighting design projects.

5.1 Current Specifications Book

The current version of the Mn/DOT Standard Specifications for Construction must be used on projects.

The edition of the “Standard Specification for Construction” which applies to a particular project will be noted on the Title Sheet of the Plan. The note on the Plan will read:

The 2005 Edition of the Minnesota Department of Transportation “Standard Specification for Construction” shall govern.

In case of discrepancy, calculated dimensions will govern over scaled dimensions; Special Provisions will govern over Standard and supplemental Specifications and Plans; Plans will govern over Standard and supplemental Specifications; supplemental Specifications will govern over Standard Specifications.

The Engineer will decide all issues concerning errors and omissions that are not otherwise resolved by logical conclusion or Contract modification. Both parties to the Contract shall inform each other as to any discrepancies they uncover, and neither the Contractor nor the Engineer shall take advantage of any error or omission.

The standard specification book is for sale by the Manual Sales Office, State of Minnesota, Department of Transportation, 395 John Ireland Blvd., St. Paul, MN 55155-1899. Information may be obtained by calling get updated number.

5.2 Special Provisions

The special provisions for a lighting project should give any necessary information that is not given in the plans or in the Mn/DOT Standard Specifications for Construction, as well as information that is to be specially brought to the bidders' attention. This information may include an explanation of the electrical distribution system, materials specifications for materials that are not in the standard specifications book, construction requirements that are not included in the standard specifications book, a statement of items that are to be furnished by the state, and an explanation of what is included in each pay item not listed in the specification book.

All districts will be responsible for preparing lighting special provisions. Sample lighting special provisions can be found on the Office of Traffic, Safety and Technology website.

A copy of the Special Provisions can be found at

www.dot.state.mn.us/trafficeng/lighting/lightingspec.html.

5.3 Agreements (Cost and/or Maintenance)

An agreement is a legal document detailing the cost responsibility of the various parties involved in installing, maintaining, and providing power to a lighting system. The district prepares agreements for lighting that is not a part of a road construction project.

Agreements for lighting that is a part of a road construction project are normally prepared by the Municipal Agreements Unit of the Office of Technical Support.

5.4 Cost Sharing Policy

The most recent cost share policy can be obtained at the following URL:

<http://www.dot.state.mn.us/stateaid/>

6. SAMPLE LIGHTING PLANS (11" X 17")

7. SAMPLE LIGHTING PLANS (8.5" X 11")

This chapter includes the 35W complete roadway lighting plan set and a Rest Area lighting plan set for reference.

NOTE: The plan sets are reduced to fit in this manual and are provided as reference only.

FED. PROJ. NO. IM 35W-3(294)

MINNESOTA DEPARTMENT OF TRANSPORTATION

CONSTRUCTION PLAN FOR ELECTRIC LIGHTING SYSTEM

LOCATED ON T.H. 35W FROM T.H. 280 TO CO. RD. E2

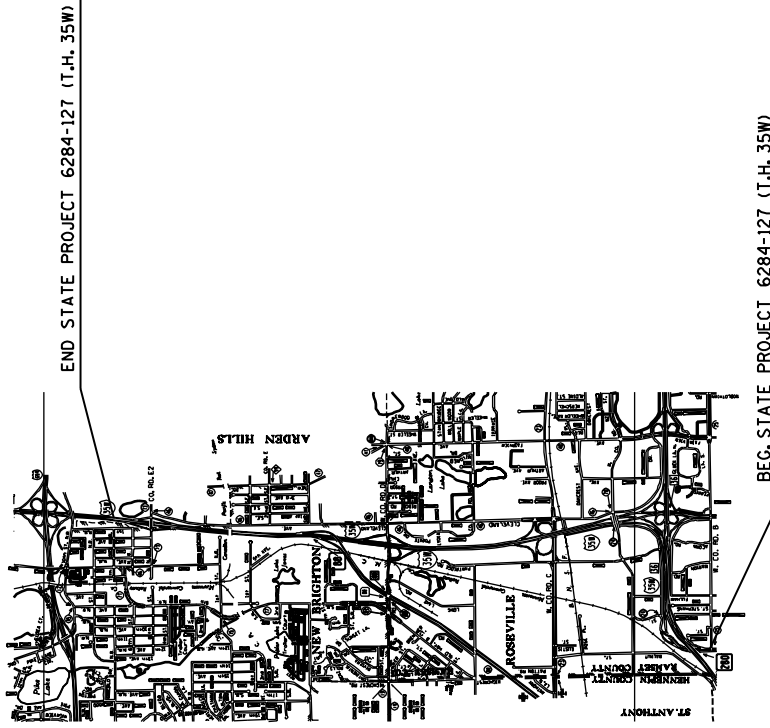

BEC. STATE PROJECT 6284-127 (T.H. 35W)

FOR PLANS & UTILITIES SYMBOLS SEE TECHNICAL MANUAL

PROJ. NO.	CHARGE IDENTIFIER

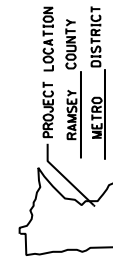

DATE	PLAN REVISIONS SHEET NO.	APPROVED BY

PLAN SCALES 100'
INDEX MAP 2200'

GOVERNING SPECIFICATIONS
THE 1988 EDITION OF THE MINNESOTA DEPARTMENT OF TRANSPORTATION STANDARD SPECIFICATIONS FOR CONSTRUCTION AS AMENDED BY THE MAY 2, 1994, SUPPLEMENTAL SPECIFICATIONS SHALL GOVERN.

INDEX

DESCRIPTION	SHEET NO.
TITLE SHEET	1
ESTIMATE AND DETAIL	2
LIGHTING DETAILS	3-13
SEWER RELOCATION	14
GUARDRAIL	15-17
SALVAGE & REMOVAL	18-24
PLAN	25-33
TRAFFIC CONTROL	34-38
UTILITIES	39-45

THIS PLAN CONTAINS 45 SHEETS

I HEREBY CERTIFY THAT THIS PLAN WAS PREPARED BY ME OR UNDER MY DIRECT SUPERVISION AND THAT I AM A DULY REGISTERED PROFESSIONAL ENGINEER UNDER THE LAWS OF THE STATE OF MINNESOTA.

DATE	REC. NO.	ENGR.	
DESIGN SQUAD	D. SCOTT	PAUL STORR	JIM ENGH
RECOMMENDED FOR APPROVAL	METRO DIVISION	TRANSPORTATION ENGINEER	20
RECOMMENDED FOR APPROVAL			20
RECOMMENDED FOR APPROVAL			20
RECOMMENDED FOR APPROVAL		STATE TRAFFIC ENGINEER	20
RECOMMENDED FOR APPROVAL		STATE PRE-LETTING ENGINEER	20
OFFICE OF LAND MANAGEMENT APPROVAL	DIRECTOR	LAND MANAGEMENT	20
APPROVED	20	STATE DESIGN ENGINEER	

I HEREBY CERTIFY THAT THE FINAL FIELD REVISIONS, IF ANY, OF THIS PLAN WERE MADE BY ME OR UNDER MY DIRECT SUPERVISION AND THAT I AM A DULY REGISTERED PROFESSIONAL ENGINEER UNDER THE LAWS OF THE STATE OF MINNESOTA.

DATE	REC. NO.	ENGR.	
------	----------	-------	--

STATEMENT OF ESTIMATED QUANTITIES

ITEM NO.	ITEM	UNIT	S.P. 6284-127 ESTIMATED QUANTITIES
2024.501	MOBILIZATION	LUMP SUM	1
2104.501	REMOVE SEWER PIPE (STORM)	LIN. FT.	168
2104.509	REMOVE LIGHT STANDARD	EACH	176
2104.509	REMOVE LIGHT STANDARD BASE	EACH	275
2104.509	REMOVE LUMINAIRE	EACH	293
2104.509	REMOVE LIGHT FIXTURE	EACH	6
2104.509	REMOVE EQUIPMENT PAD	EACH	1
2104.509	REMOVE ANCHORAGE ASSEMBLY - PLATE BEAM	EACH	2
2104.509	REMOVE ECCENTRIC LOADER BCT	EACH	1
2104.521	SALVAGE GUARD RAIL - PLATE BEAM	LIN. FT.	75
2104.523	SALVAGE LIGHT STANDARD	EACH	111
2104.523	SALVAGE SERVICE PANEL	EACH	10
2104.607	HAUL SALVAGED MATERIAL	LUMP SUM	1
2105.501	COMMON EXCAVATION	CUBIC YARD	140
2452.507	CAST-IN-PLACE CONCRETE PILING DELIVERED 12"	LIN. FT.	1920
2452.508	CAST-IN-PLACE CONCRETE PILING DRIVEN 12"	LIN. FT.	1920
2503.541	36" RC PIPE SEWER DESIGN 3006	LIN. FT.	168
2533.603	CONCRETE MEDIAN BARRIER DESIGN B337	LIN. FT.	2020
2545.511	LIGHTING UNIT TYPE 3-100	EACH	25
2545.511	LIGHTING UNIT TYPE 4-120	EACH	7
2545.511	LIGHTING UNIT TYPE VM-45	EACH	35
2545.511	LIGHTING UNIT TYPE VMD-45	EACH	3
2545.515	LIGHT BASE DESIGN T-100	EACH	25
2545.515	LIGHT BASE DESIGN T-120	EACH	7
2545.515	LIGHT BASE DESIGN H	EACH	38
2545.521	1" RIGID STEEL CONDUIT	LIN. FT.	350
2545.521	2" RIGID STEEL CONDUIT	LIN. FT.	430
2545.521	3" RIGID STEEL CONDUIT (PUSHED)	LIN. FT.	95
2545.521	4" RIGID STEEL CONDUIT (PUSHED)	LIN. FT.	2125
2545.531	UNDERGROUND WIRE 1 CONDUCTOR NO. 10	LIN. FT.	140
2545.531	UNDERGROUND WIRE 1 CONDUCTOR NO. 1/0	LIN. FT.	830
2545.531	UNDERGROUND WIRE 1 CONDUCTOR NO. 3/0	LIN. FT.	1650
2545.533	ARMORED CABLE 3 CONDUCTOR NO. 4	LIN. FT.	790
2545.541	SERVICE PANEL SECONDARY TYPE L1	LIN. FT.	48000
2545.541	SERVICE PANEL SECONDARY TYPE L2	EACH	3
2545.545	SERVICE EQUIPMENT	EACH	5
2545.545	EQUIPMENT PAD B	EACH	2
2545.551	JUNCTION BOX	EACH	8
2545.553	PULL BOX	EACH	7
2545.602	UNDERPASS LIGHTING UNIT TYPE L	EACH	9
2545.602	INSTALL SERVICE PANEL	EACH	16
2545.602	INSTALL SERVICE PANEL	EACH	2
2554.501	TRAFFIC BARRIER DESIGN B6307	LIN. FT.	700
2554.511	INSTALL TRAFFIC BARRIER DESIGN B6307	LIN. FT.	75
2554.521	ANCHORAGE ASSEMBLY PLATE BEAM	EACH	1
2554.523	END TREATMENT - ENERGY ABSORBING TERMINAL	EACH	2
2554.602	IMPACT ATTENUATOR BARRELS	EACH	26
2554.602	CONNECTING PIN	EACH	198
2563.601	TRAFFIC CONTROL	LUMP SUM	1
2363.603	MEDIAN BARRIER DELINEATOR	EACH	68
2573.502	SILT FENCE, TYPE HEAVY DUTY	LIN. FT.	1500
2575.555	TURF ESTABLISHMENT	LUMP SUM	1

- (1) INCLUDES 24 - 7.5 DEG BENDS
- (2) ET 2000
- (3) INSTALL SALVAGED SERVICE PANEL TYPE L1
- (4) CONTRACTOR OWNED
- (5) FOR SALVAGING, STOCKPILING AND PLACING OF TOPSOIL
- (6) APPROX. 0.5 ACRE

THE FOLLOWING STANDARD PLATES APPROVED BY THE DEPT. OF TRANSPORTATION AND THE FEDERAL HIGHWAY ADMINISTRATION SHALL APPLY ON THIS PROJECT.

PLATE NO.	DESCRIPTION
3000L	REINFORCED CONCRETE PIPE
3006G	GASKET JOINT FOR RC PIPE
8000I	STANDARD BARRICADES
8106A	EQUIPMENT PAD B
8114A	PULL BOX / HANDHOLE
8128B	LIGHT BASE DESIGN H
M8140B	ROADWAY LIGHTING SERVICE CABINET
8307P	STEEL PLATE BEAM GUARDRAIL

(A) METRIC STANDARD PLATE

CERTIFIED BY: *Steven J. Leibel*
PROFESSIONAL ENGINEER

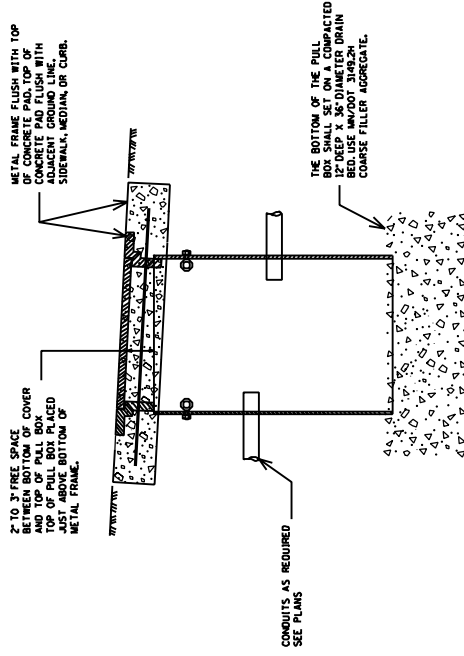
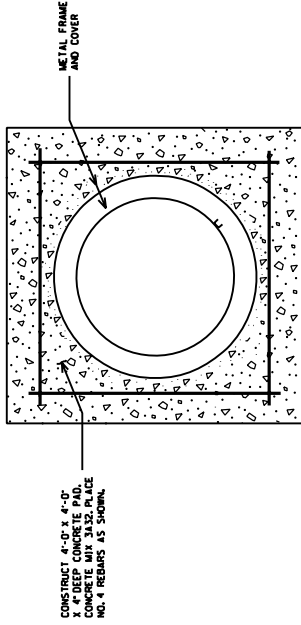

PULL BOX WITH CONCRETE SURROUND
SEE STANDARD PLATE 8114 FOR PULL BOX CONSTRUCTION DETAILS

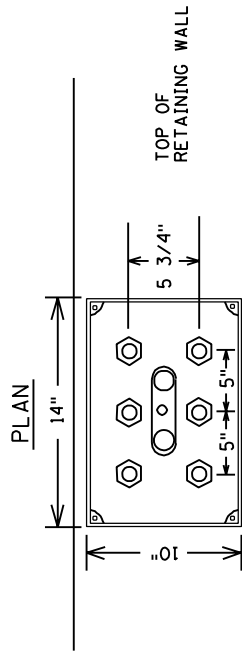

PROVIDE HOLES IN BOTTOM OF JUNCTION BOX TO FIT EXISTING ANCHOR BOLTS AND CONDUIT. FIELD CHECK ANCHORAGES AND CONDUIT BEFORE DRILLING

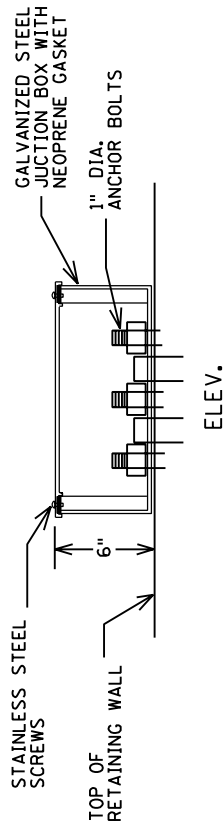

JUNCTION BOX ON RETAINING WALL
2 REQUIRED

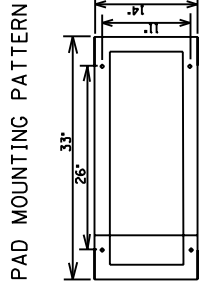
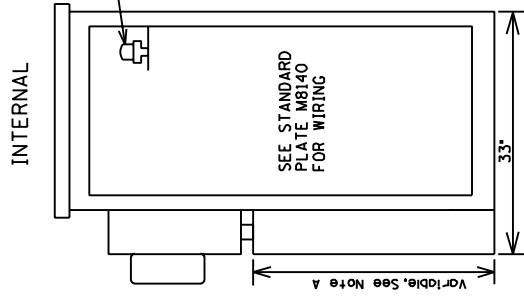
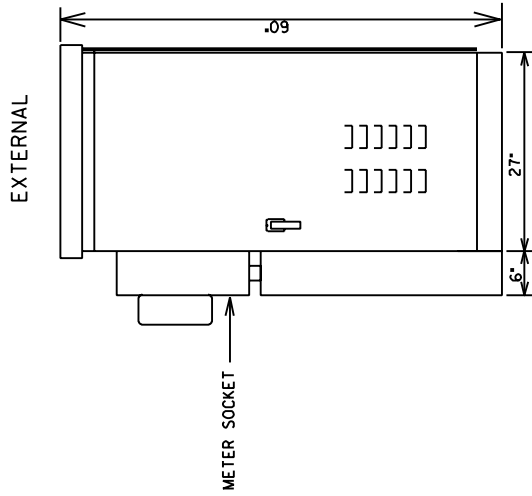

Note A: Height of compartment is approximately 33".
May vary depending upon size of meter socket.

SIDE VIEWS

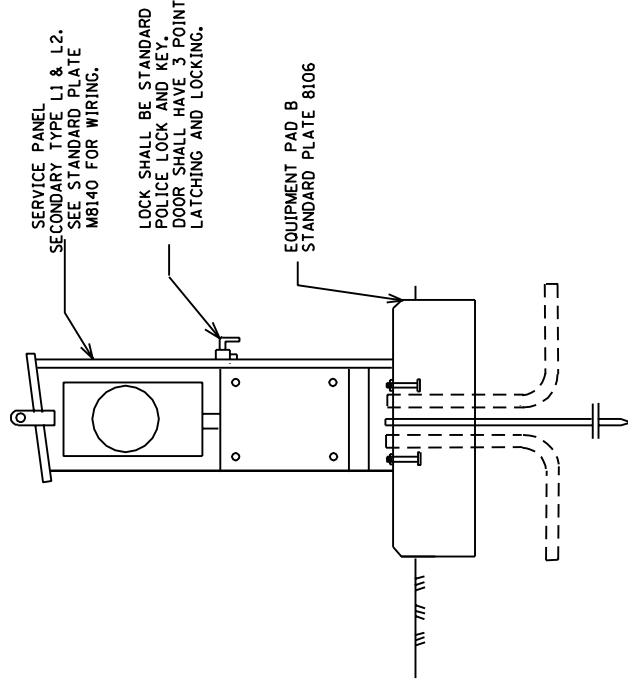
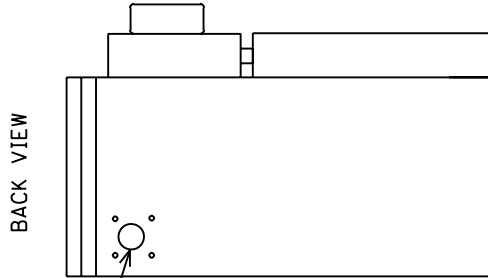
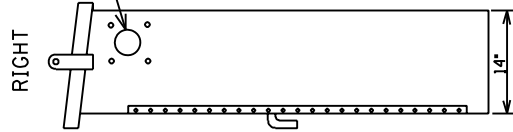
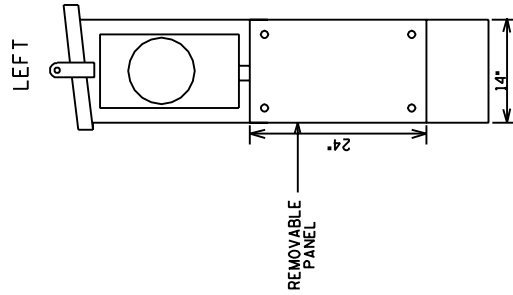

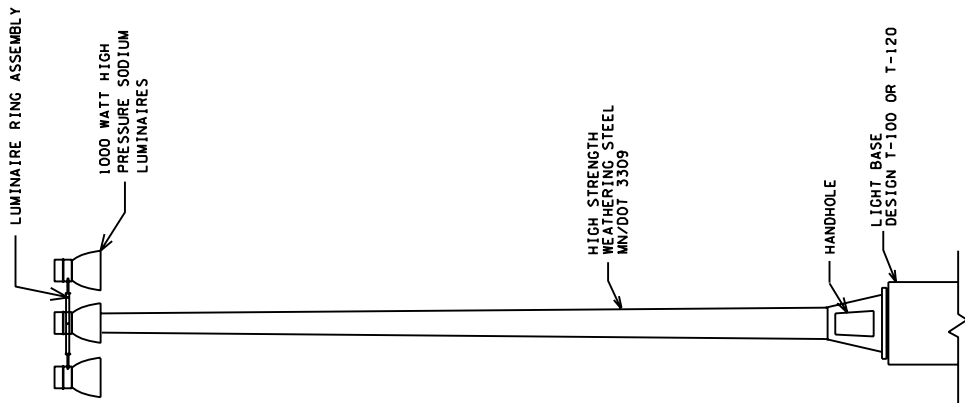

LIGHTING UNIT TYPE 3-100 & 4-120

TYPICAL 3 LUMINAIRE RING

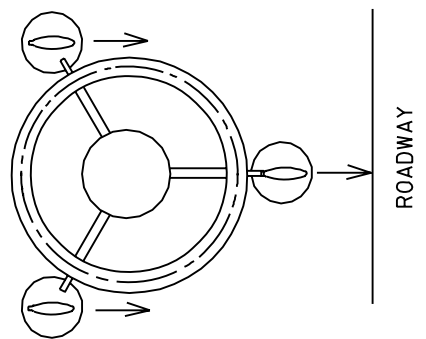

ORIENT LUMINAIRES TO ROADWAY AS SHOWN ON THE PLANS FOR ASYMMETRICAL DISTRIBUTION

TYPICAL 4 LUMINAIRE RING

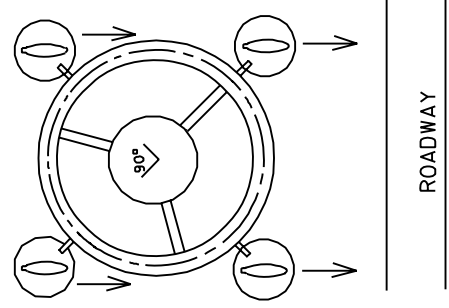

ORIENT LUMINAIRES TO ROADWAY AS SHOWN ON THE PLANS FOR ASYMMETRICAL DISTRIBUTION

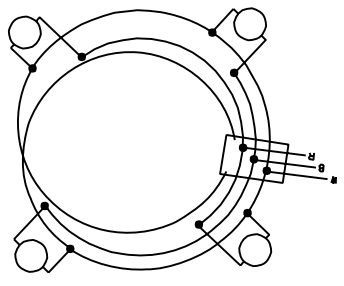

TYPICAL 4 LUMINAIRE WIRING DETAIL

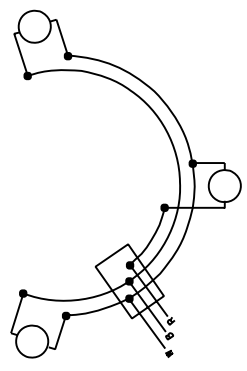

TYPICAL 3 LUMINAIRE WIRING DETAIL

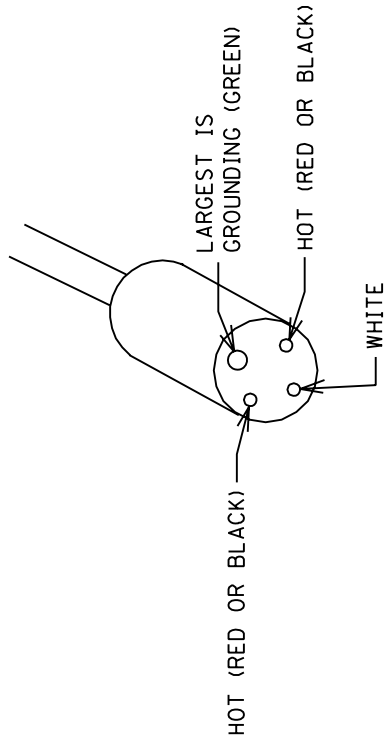

WIRING OF TOWER PLUGS

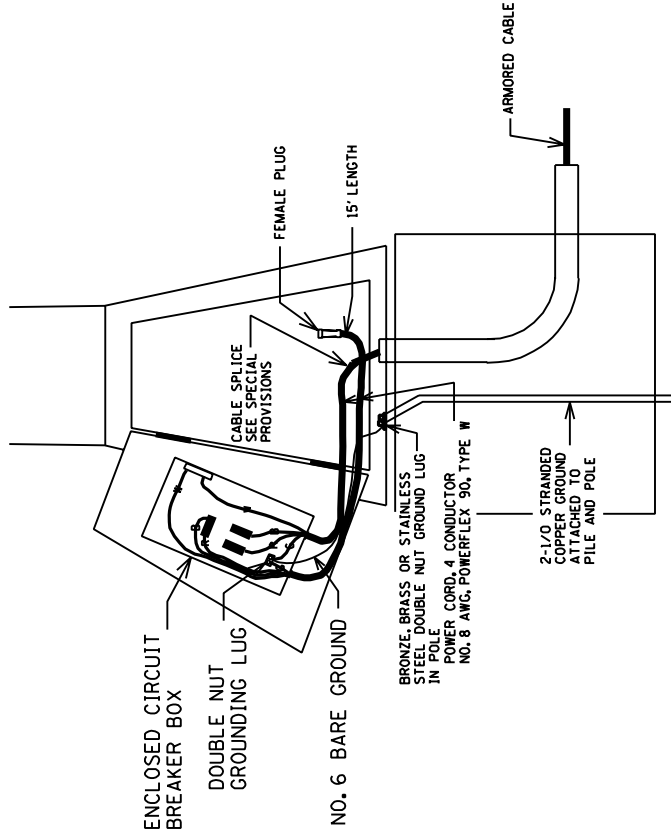

GROUNDING AND WIRING OF HIGH MAST LIGHTING UNIT

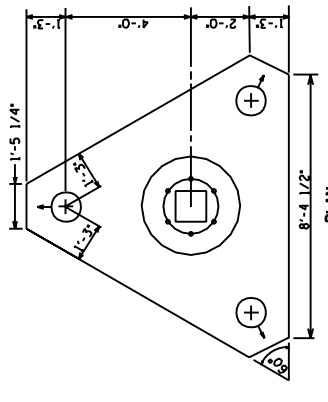

PLAN

THE REINFORCING SHALL BE 66-66 STEEL FABRIC (MM/DDOT 3303) 4'D, X 6' X 6' CONCRETE WALK IN FRONT OF TOWER HANDHOLE. CONCRETE MIX NO. 3A32. CONTRACTOR SHALL FINISH GRADING THE SITE TO BLEND WITH EXISTING SLOPES AS DIRECTED BY THE ENGINEER.

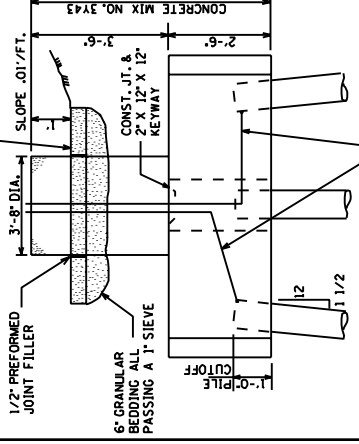

ELEVATION

2-1/0 STRANDED COPPER GROUND WIRE CLAMP TO PILE AND POLE. CLAMPS SHALL BE APPROVED BY THE ENGINEER

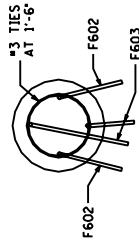

PILE REINFORCEMENT CAGE DETAILS

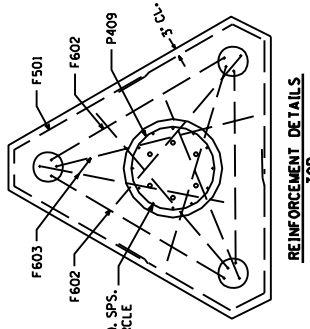

REINFORCEMENT DETAILS TOP

12-P908 EO. SPS. 37" DIA. CIRCLE

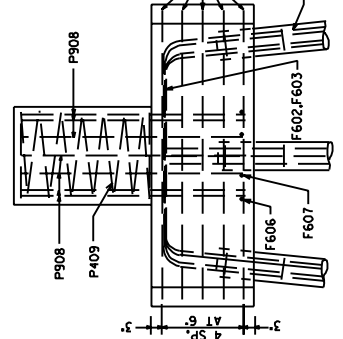

REINFORCEMENT DETAILS

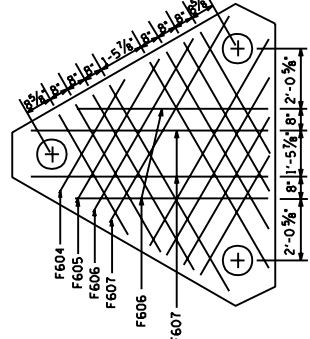

REINFORCEMENT DETAILS BOTTOM

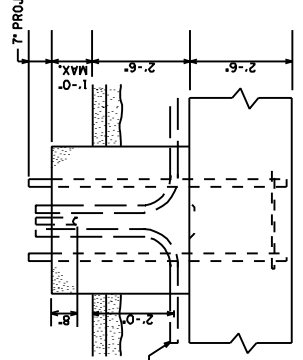

ANCHOR DETAILS

2" PVC AS REQUIRED SEE SPECIAL PROVISIONS, ADD ONE ADDITIONAL 2" PVC FOR ALTERNATE GROUNDING

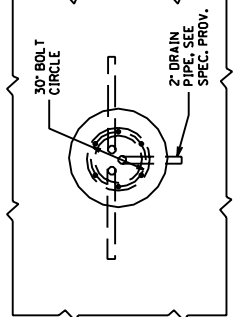

PEDESTAL DETAILS

PILE SPACING SHOWN IS AT BOTTOM OF FOOTING. REINFORCEMENT BARS OTHER THAN SPIRAL ROD PER MARKED DIRECTIONS BE BATTERED 1 1/2% PILES TO HAVE A NOMINAL DIAMETER OF 12". WALL THICKNESS SHALL NOT BE LESS THAN .250. PILES SHALL HAVE A PENETRATION OF NOT LESS THAN 20 FT. BELOW CUT-OFF. PREBORING WILL BE REQUIRED IF NECESSARY TO OBTAIN THIS PENETRATION. ESTIMATE PENETRATION 1 FT. LES THAN LENGTH GIVEN.

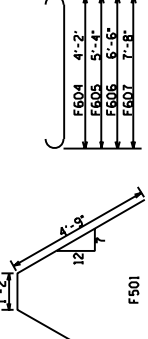

BAR DETAILS

LIGHT BASE DESIGN T-100

2-SEMI-FINISHED NUTS, 1/2" THICK, 1" O.D. HARDENED AND BLACK GALVANIZED. PER 3392

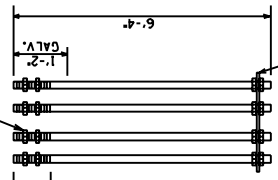

2" DIA. RODS PER 3385, TYPE C.

2-HEAVY HEX NUTS, 1/2" THICK, 1" O.D. HARDENED AND BLACK GALVANIZED. PER 3392

ANCHOR BOLT ASSEMBLY

BILL OF REINFORCEMENT		
BAR NO.	LENGTH	SHAPE
F501	10'-8"	FOOTING TIE
F602	11'-5"	PILE TIE (TOP)
F603	13'-8"	PILE TIE (TOP)
F604	4	FOOTING LONGIT. BOL.
F605	4	FOOTING LONGIT. BOL.
F606	6	FOOTING LONGIT. BOL.
F607	6	FOOTING LONGIT. BOL.
P908	12	5'-10" PEDESTAL SPIRALS
P409	1	SEE DETAIL

FIRST DIGIT OF BAR MARK INDICATES BAR SIZE REINFORCEMENT BARS OTHER THAN SPIRAL ROD STOCK SHALL BE PERFORMER BILLET STEEL BARS CONFORMING TO ASTM 615 GRADE 40.

TOWER NO.	DESIGN LOAD TONS/PILE	NUMBER OF PILES	ESTIMATED LENGTH+FT.
W6A/1	20	3 @ 20 FT.	60
W6C/1	20	3 @ 20 FT.	60
W6E/2	20	3 @ 20 FT.	60
W6H/1	20	3 @ 20 FT.	60
W6H/2	20	3 @ 20 FT.	60
W6H/3	20	3 @ 20 FT.	60
W6H/4	20	3 @ 20 FT.	60
W6E/1	20	3 @ 20 FT.	60
W6E/2	20	3 @ 20 FT.	60
W6E/3	20	3 @ 20 FT.	60
W6A/1	20	3 @ 20 FT.	60
W6A/2	20	3 @ 20 FT.	60
W6A/3	20	3 @ 20 FT.	60
W6A/4	20	3 @ 20 FT.	60
W6A/5	20	3 @ 20 FT.	60
W6A/6	20	3 @ 20 FT.	60
W6A/7	20	3 @ 20 FT.	60
W6A/8	20	3 @ 20 FT.	60
W6A/9	20	3 @ 20 FT.	60
W6A/10	20	3 @ 20 FT.	60
W6A/11	20	3 @ 20 FT.	60
W6A/12	20	3 @ 20 FT.	60
W6A/13	20	3 @ 20 FT.	60
W6A/14	20	3 @ 20 FT.	60
W6A/15	20	3 @ 20 FT.	60
W6A/16	20	3 @ 20 FT.	60
W6A/17	20	3 @ 20 FT.	60
W6A/18	20	3 @ 20 FT.	60
W6A/19	20	3 @ 20 FT.	60
W6A/20	20	3 @ 20 FT.	60

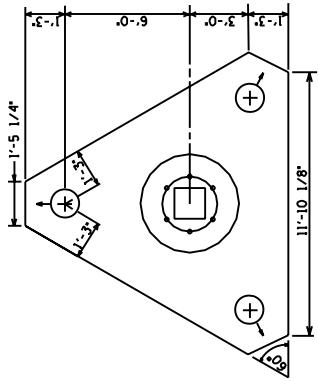

PLAN

THE REINFORCING SHALL BE 66-66 STEEK FABRIC 6M/DOIT 33031 4"D. X 6' X 6' CONCRETE WALK IN FRONT OF TOWER HANDHOLE. CONCRETE MIX NO. 3A32. CONTRACTOR SHALL FINISH GRADING THE SITE TO BLEND WITH EXISTING SLOPES AS DIRECTED BY THE ENGINEER.

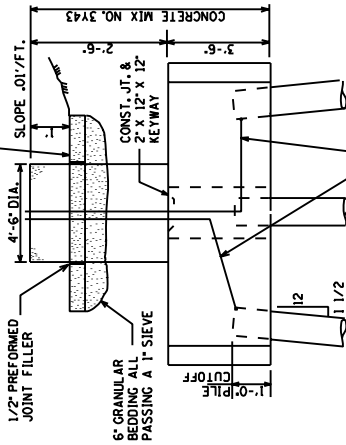

ELEVATION

2-1/0 STRANDED COPPER GROUND WIRE CLAMP TO PILE AND POLE. CLAMPS SHALL BE APPROVED BY THE ENGINEER.

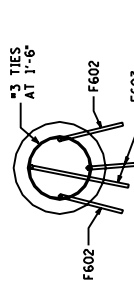

PILE REINFORCEMENT CAGE DETAILS

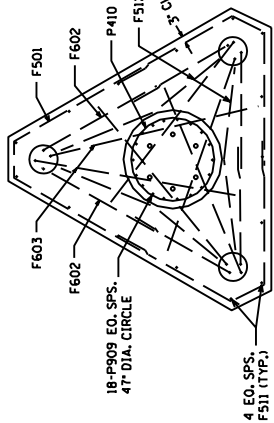

REINFORCEMENT DETAILS TOP

18-P909 EQ. SPS. 47" DIA. CIRCLE
4 EQ. SPS. F511 (TYP.)

2-SEMI-FINISHED NUTS, AND TWO HARDENED WASHERS, GALVANIZED, PER 3392
2-DIA. RODS PER 3385, TYPE C.
2-HEAVY HEX. NUTS, 1/2 THICK X 3-WIDE ROLLED RING W/6 2-1/16" DIA. HOLES EQ. SP. PER MN/DOIT 3306 ANCHOR BOLT ASSEMBLY

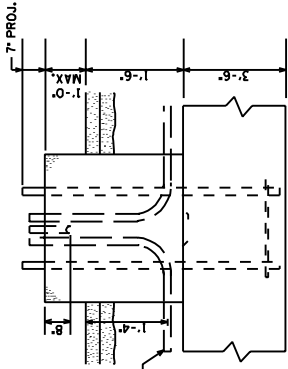

ANCHOR DETAILS

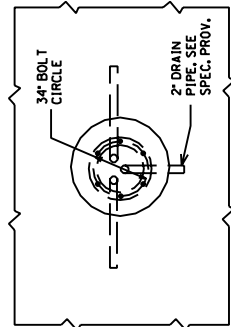

PEDESTAL DETAILS

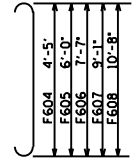
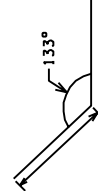

REINFORCEMENT DETAILS

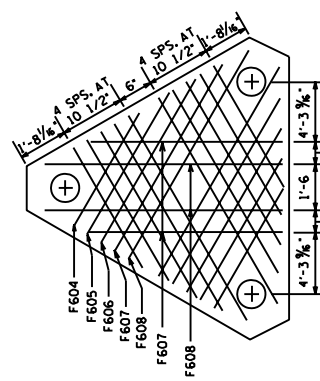

REINFORCEMENT DETAILS BOTTOM

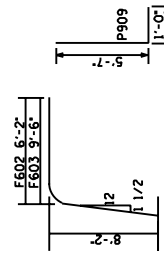

BAR DETAILS

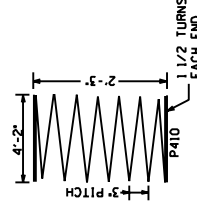

BAR DETAILS

BAR NO.	LENGTH	SHAPE	LOCATION
F501	18	14'-8"	FOOTING TIE
F603	6	14'-4"	PILE TIE (TOP)
F604	4	5'-9"	FOOTING LONGIT. BOL.
F605	4	7'-4"	FOOTING LONGIT. BOL.
F606	6	10'-5"	FOOTING LONGIT. BOL.
F608	6	12'-0"	FOOTING LONGIT. BOL.
P410	1	SEE RETAIL	PEDESTAL SPIRAL
F511	15	3'-0"	FOOTING CORNER
F512	3	9'-0"	FOOTING TOP

FIRST DIGIT OF BAR MARK INDICATES BAR SIZE. REINFORCEMENT BARS OTHER THAN SPIRAL ROD STOCK SHALL BE DEFORMED BILLET STEEL BARS CONFORMING TO ASTM A615 GRADE 60. PILE SPACING SHALL BE 12" ON CENTER. PILES SPACING SHALL BE 12" ON CENTER. PILES TO HAVE A NOMINAL DIAMETER OF 12". WALL THICKNESS SHALL NOT BE LESS THAN .250. PILES SHALL HAVE A PENETRATION OF NOT LESS THAN 20 FT. BELOW CUT-OFF. PREBORING WILL BE REQUIRED IF NECESSARY TO OBTAIN THIS PENETRATION. ESTIMATE PENETRATION 1 FT. LESS THAN LENGTH GIVEN.

TOWER NO.	DESIGN LOAD TONS/PILE	NUMBER OF PILES	ESTIMATED LENGTH-FT.
MEC/2	27	3 B 20 FT.	60
MEC/3	27	3 B 20 FT.	60
MEC/4	27	3 B 20 FT.	60
MEP/2	27	3 B 20 FT.	60
MEP/4	27	3 B 20 FT.	60
MEP/1	27	3 B 20 FT.	60

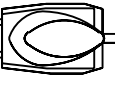

250 WATT HIGH PRESSURE SODIUM LUMINAIRE



250 WATT HIGH PRESSURE SODIUM LUMINAIRE

VERTICAL MOUNT LUMINAIRES

G.E. TURNPIKE REGULATED BALLAST FOR 240 VOLTS, CAT. NO. RPF25S0A1GLN3GRS
AMERICAN ELECTRIC INTERSTATE II, REGULATED BALLAST FOR 240 VOLTS, CAT. NO. 7760H132N000
LAMPS SHALL BE 250 WATT HIGH PRESSURE SODIUM LUMINAIRES SHALL HAVE A TYPE III SEMI-CUTOFF DISTRIBUTION

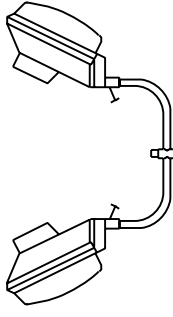

- STAINLESS STEEL HIGH BASE
- ALUMINUM TRANSFORMER BASE
- LIGHT BASE DESIGN H
- STANDARD PLATE 8128

LIGHTING UNIT TYPE VMD-45 (BREAKAWAY)



- STAINLESS STEEL HIGH BASE
- ALUMINUM TRANSFORMER BASE
- LIGHT BASE DESIGN H
- STANDARD PLATE 8128

LIGHTING UNIT TYPE VM-45 BREAKAWAY

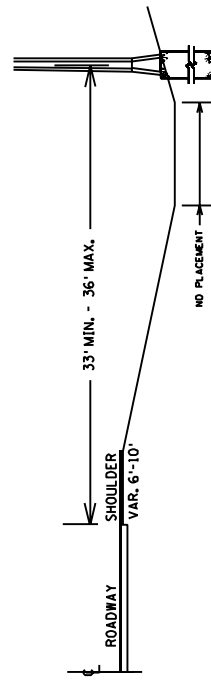
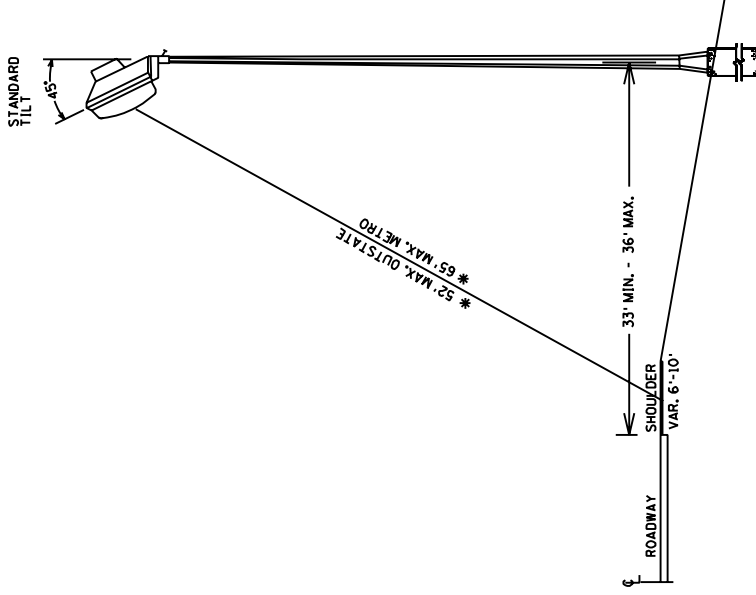
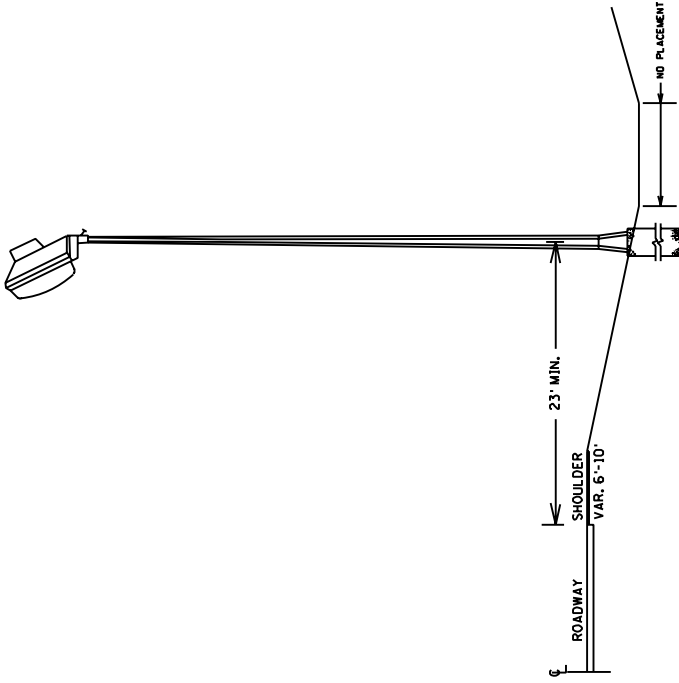

USE THE MAXIMUM DISTANCE WHENEVER POSSIBLE. IF THE MINIMUM DISTANCE CANNOT BE OBTAINED CONTACT THE DISTRICT/DIVISION TRAFFIC ENGINEER LIGHT BASES SHALL BE INSTALLED IN ACCORDANCE WITH 2545.3F2. DISTANCES SHALL BE MEASURED FROM THE EDGE OF DRIVING LANE OR TURN LANE.
 * WORKING LIMITS OF BUCKET TRUCK

PLACEMENT OF LIGHTING UNITS TYPE VM

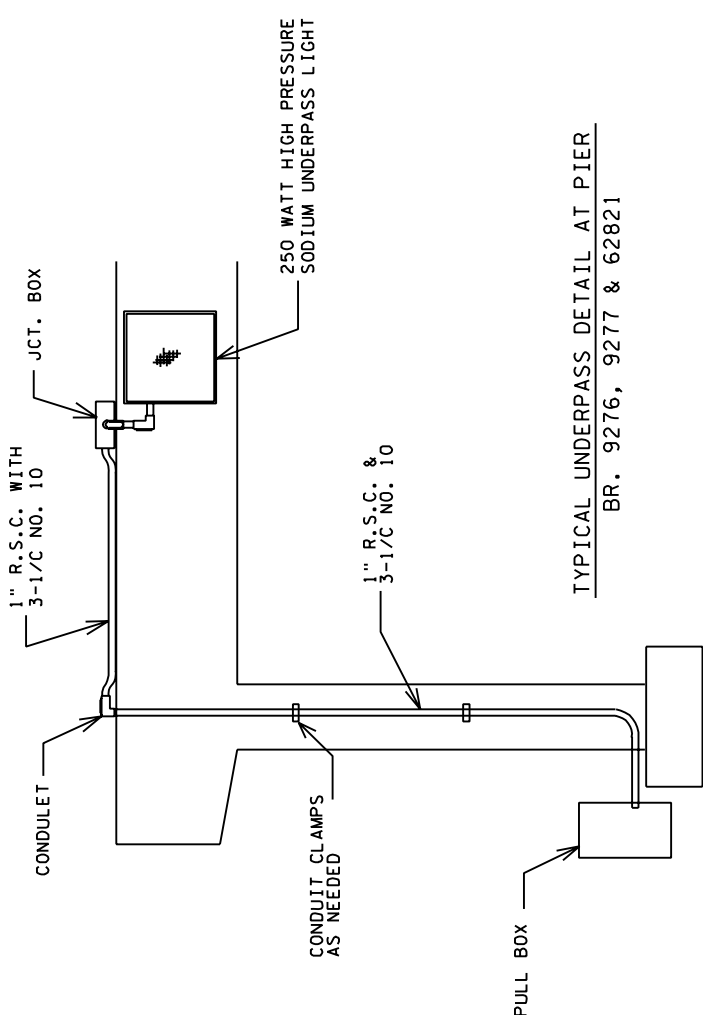

TYPICAL UNDERPASS DETAIL AT PIER
BR. 9276, 9277 & 62821

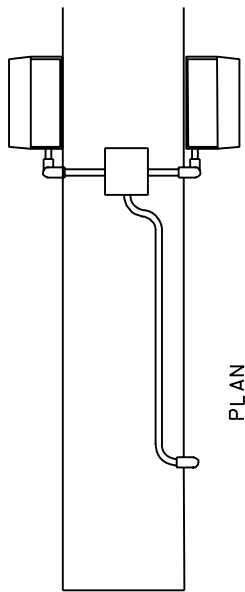

PLAN
BR. 9276 & 9277

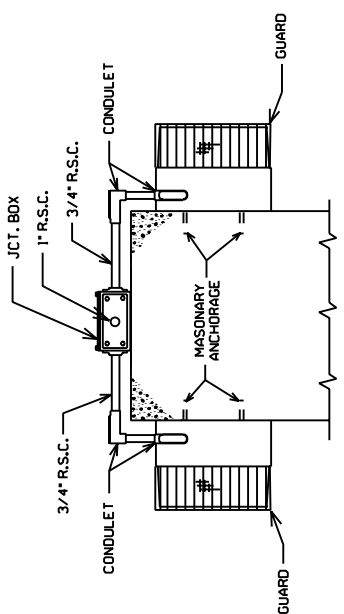

UNDERPASS LIGHTING UNIT TYPE L
250 WATT HIGH PRESSURE SODIUM

1. THE JUNCTION BOXES SHALL BE 8-1/2" L. X 8-1/2" W. X 4" D. WITH REMOVABLE HUB PLATES AND MOUNTING LUGS.
2. FASTEN RIGID STEEL CONDUIT WITH CABLE CLAMPS ABOUT 5'-0" ON CENTER.
3. FASTEN CLAMPS AND JUNCTION BOXES TO CONCRETE WITH MASONRY ANCHORAGES OR POWER ACTIVATED STUDS.

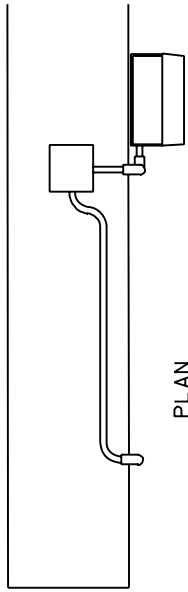

PLAN
BR. 62821

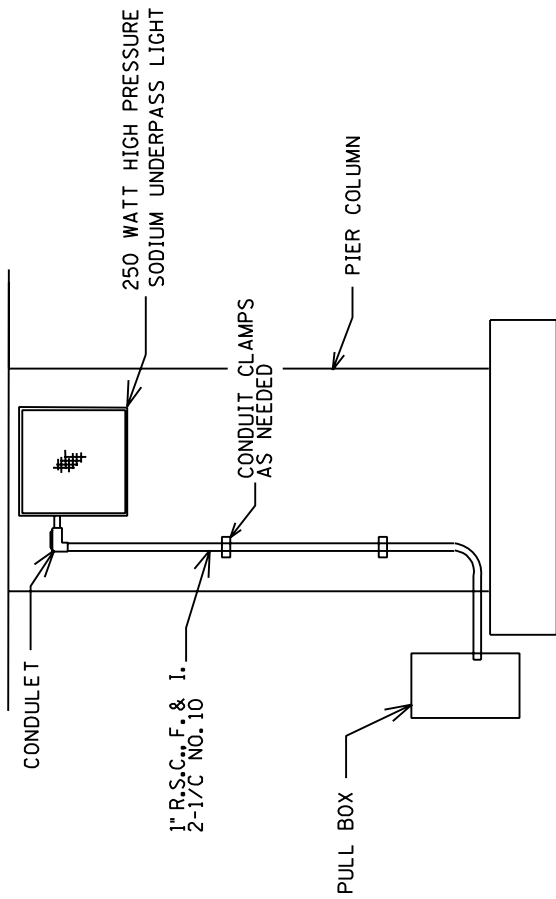

TYPICAL

PIER 3 BR. 9588, PIER 2 & PIER 4 BR. 9569 AND PIER 2 BR. 62853

UNDERPASS DETAILS

CERTIFIED BY *Debra J. Ladd*
PROFESSIONAL ENGINEER

REG. NO. 21180

State Proj. No. 6284-127 (T.H. 35W) Sheet No. 12 of 45 Sheets



W6C/1
 SALVAGE 37.5' TRAFFIC BARRIER
 (25' PREFORMED RAIL SECTION & 12.5' RADIUS NOSE SECTION)
 EXTEND GUARDRAIL 100'
 INSTALL SALVAGED 37.5' TRAFFIC BARRIER
 (25' PREFORMED RAIL SECTION & 12.5' RADIUS NOSE SECTION)

W6H/5
 REMOVE ANCHORAGE ASSEMBLIES
 EXTEND GUARDRAIL 400'
 F.&I. RADIUS NOSE (12.5')

W6H/2 S.B. ROADWAY
 REMOVE END TREATMENT
 EXTEND GUARD RAIL 37.5'
 F.&I. ET 2000
 W6H/2 N.B. ROADWAY
 REMOVE END TREATMENT
 EXTEND GUARDRAIL
 F.&I. ET 2000
 F.&I. ANCHORAGE ASSEMBLY

RAD. MOUNTED SOURCE OF POWER
 SERVICE PANEL, SECONDARY TYPE
 EQUIPMENT AND METERED.
 2.3" RSC IMP.
 ON 73
 4-250 W.A.V.

W6E/2
 SALVAGE 37.5' TRAFFIC BARRIER
 (25' PREFORMED RAIL SECTION & 12.5' RADIUS NOSE SECTION)
 EXTEND GUARDRAIL 100'
 INSTALL SALVAGED 37.5' TRAFFIC BARRIER
 (25' PREFORMED RAIL SECTION & 12.5' RADIUS NOSE SECTION)

ON 48
 1-250 W.A.V.

OFF
 ON 71
 NO LIGHTS

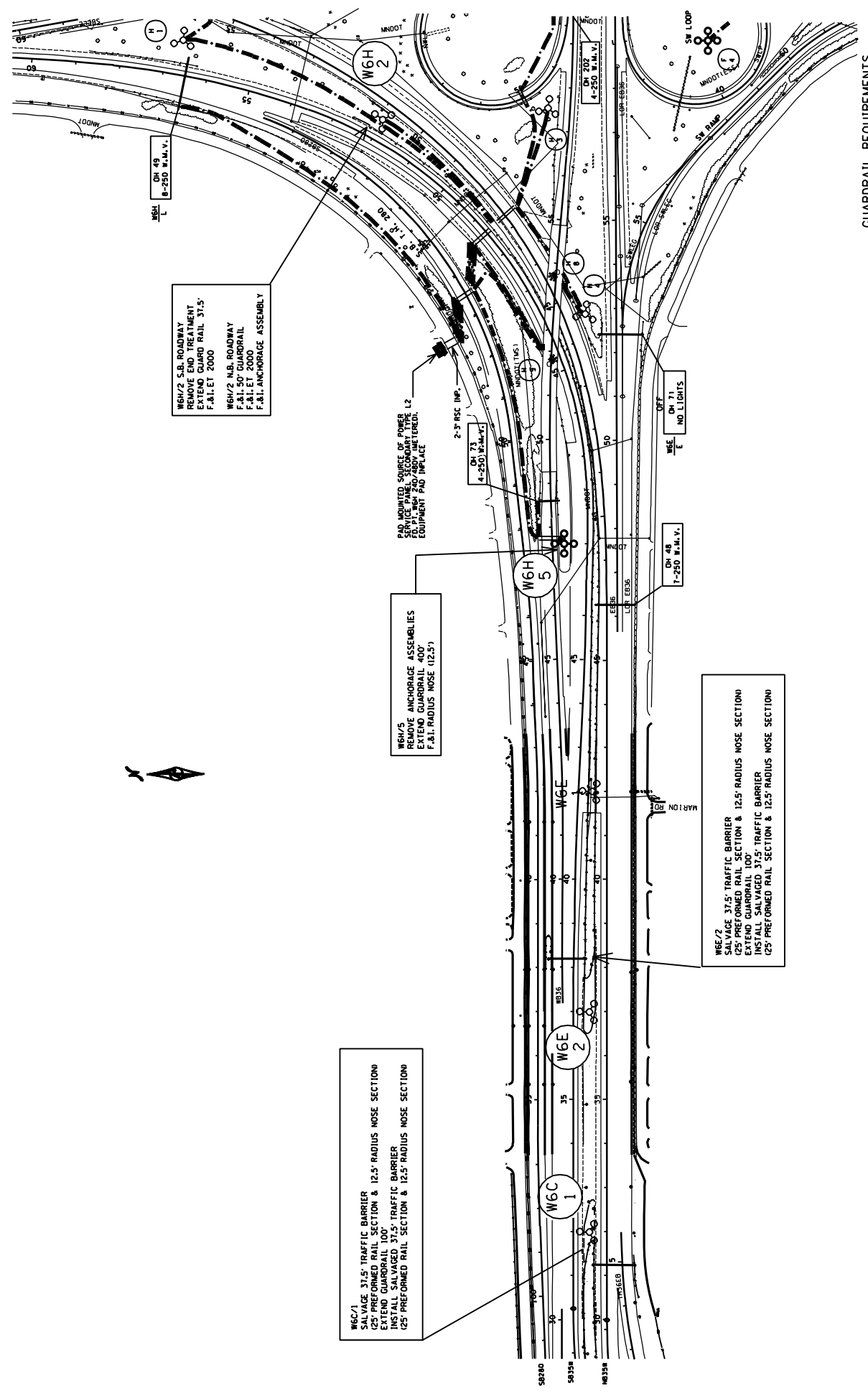

GUARDRAIL REQUIREMENTS

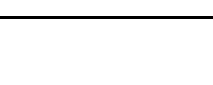
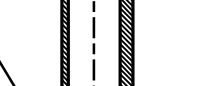
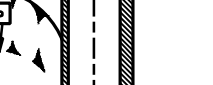
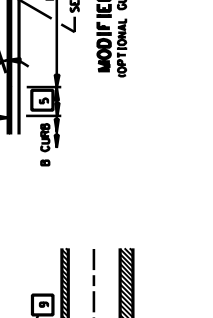
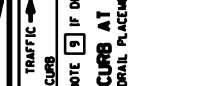
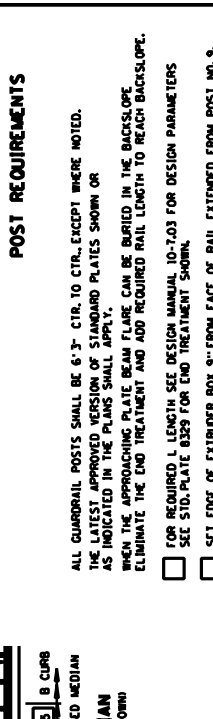
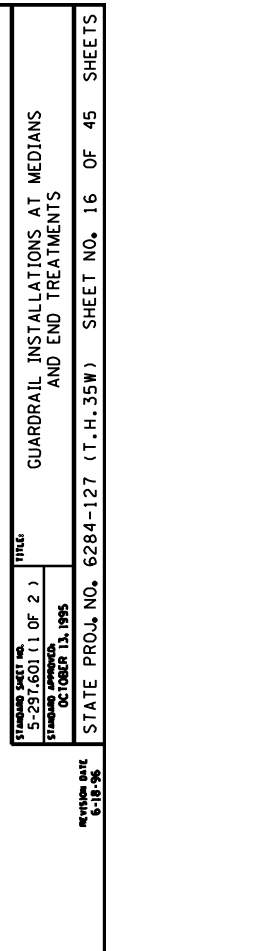
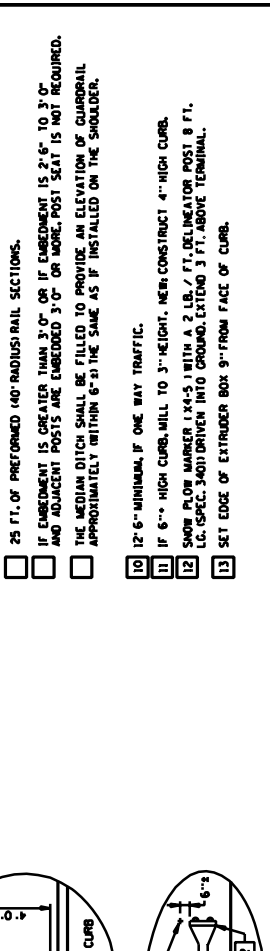
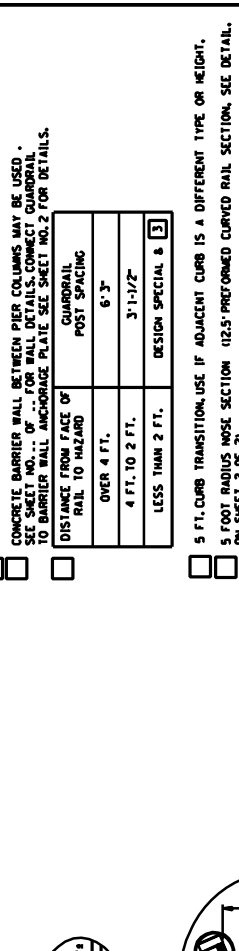
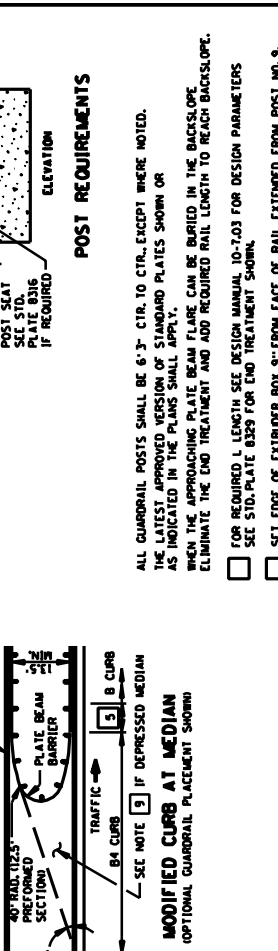
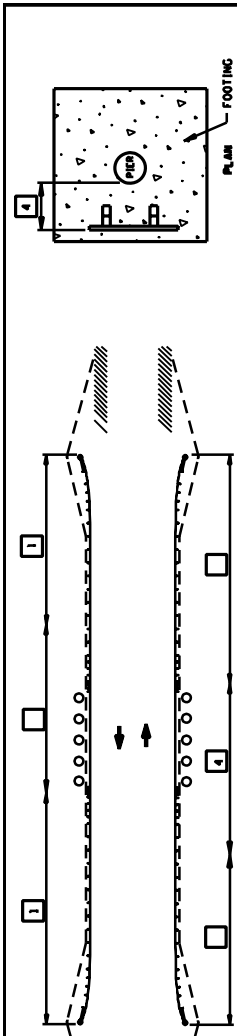

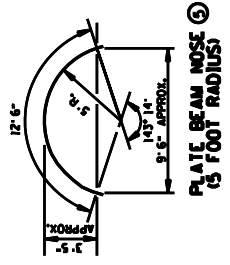
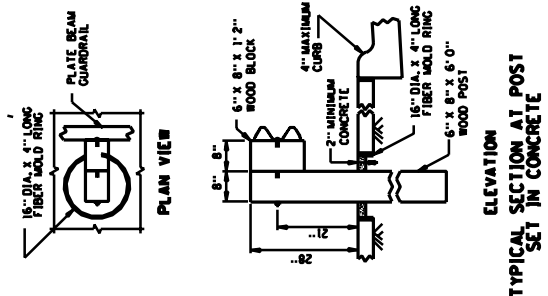
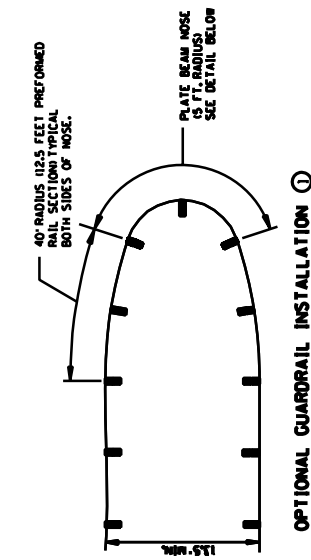
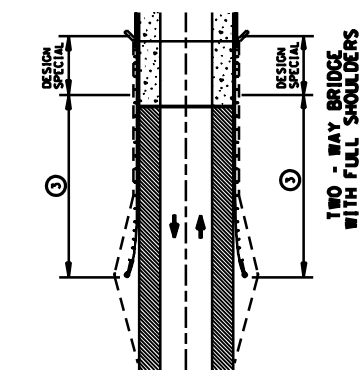
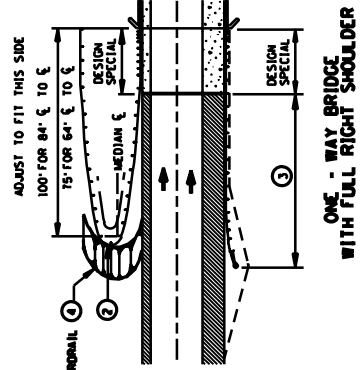
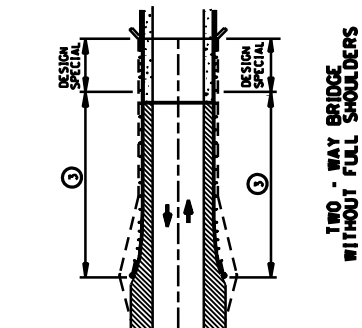
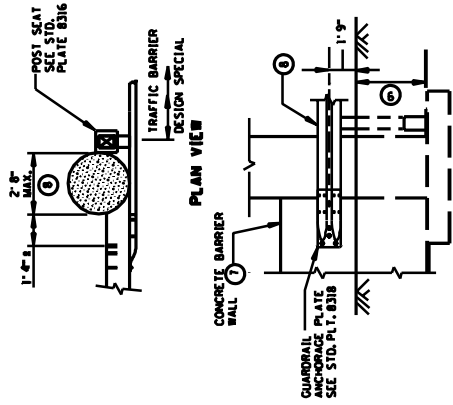

- NOTES:**
 ALL GUARDRAIL POSTS SHALL BE 6" 3" CTR. TO CTR., EXCEPT WHERE NOTED.
 WHEN THE APPROACHING PLATE BEAM FLARE CAN BE BURIED IN THE BACKSLOPE, ELIMINATE THE END TREATMENT AND ADD REQUIRED RAIL LENGTH TO REACH BACKSLOPE. THE LATEST APPROVED VERSION OF STANDARD PLATES SHOWN OR AS INDICATED IN THE PLANS SHALL APPLY.
- (1) OPTIONAL GUARDRAIL AS DETERMINED BY THE DESIGNER AND SPECIFIED ON SHEET NO. _____ OF _____.
 - (2) 5 FOOT RADIUS NOSE SECTION 1/2.5 PREFORMED CURVED RAIL SECTION. SEE DETAIL.
 - (3) FOR THE REQUIRED L LENGTH SEE ROAD DESIGN MANUAL 10-7.03 FOR DESIGN PARAMETERS. SEE STANDARD PLATE B329 FOR END TREATMENT SHOWN.
 - (4) THE MEDIAN DITCH SHALL BE FILLED TO PROVIDE AN ELEVATION OF GUARDRAIL APPROXIMATELY WITHIN 6"± THE SAME AS IF INSTALLED ON THE SHOULDER. EXTEND FILL TO GUARDRAIL NOSE AND TAPER TO MEDIAN DITCH ON 10% SLOPE.
 - (5) STANDARD PLATE BEAM GUARDRAIL SECTION HAVING STANDARD PUNCHING AT BOTH ENDS WITH INTERMEDIATE 3/4" x 2-1/2" SLOT. SEE STANDARD PLATE B307.
 - (6) NOTE (1) AND ALTERNATE GUARDRAIL AS DETERMINED BY THE DESIGNER AND SPECIFIED ON SHEET NO.
 - (7) CONCRETE BARRIER WALL BETWEEN BRIDGE PIER COLUMNS - SEE SHEET NO. FOR WALL DETAILS.
 - (8) FOR COLUMN DIAMETERS LARGER THAN 2' 0", FIELD PUNCH THE GUARDRAIL FOR THE FIRST POST AS SHOWN.
 - (9) IF EMBEDMENT IS GREATER THAN 3' 0" OR IF EMBEDMENT IS 2' 6" TO 3' 0" AND ADJACENT POSTS ARE EMBEDDED 3' 0" OR MORE, POST SEAT IS NOT REQUIRED.

STANDARD SHEET NO. 5-297.60J (2 OF 2)	TITLE GUARDRAIL INSTALLATIONS AT MEDIANS AND END TREATMENTS
STANDARD APPROVED OCTOBER 13, 1995	
STATE PROJ. NO. 62B4-127 (T.H.35W) SHEET NO. 17 OF 45 SHEETS	

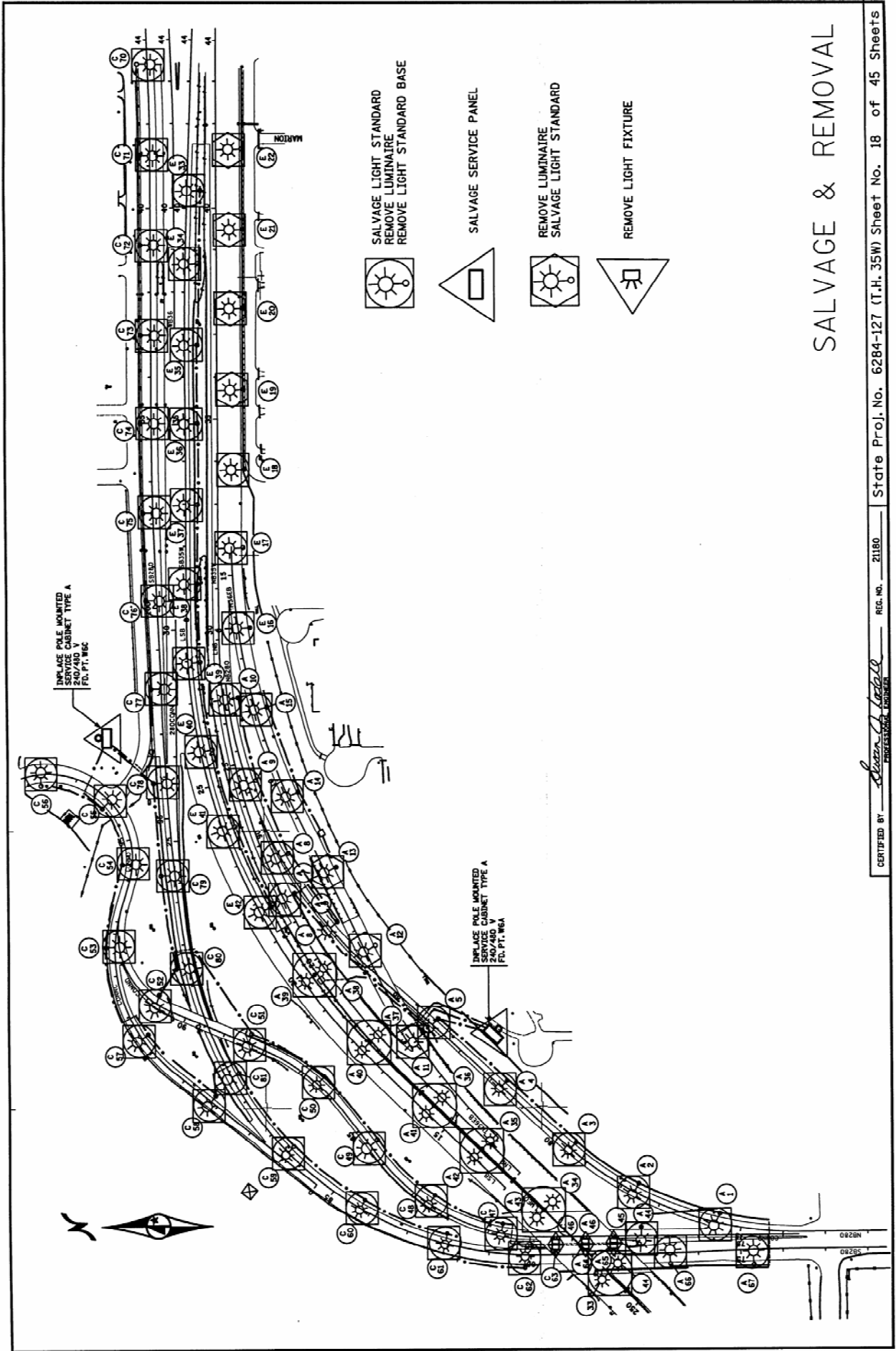

SALVAGE LIGHT STANDARD
 REMOVE LUMINAIRE
 REMOVE LIGHT STANDARD BASE



SALVAGE SERVICE PANEL











REMOVE LUMINAIRE
 SALVAGE LIGHT STANDARD



REMOVE LIGHT FIXTURE



SALVAGE & REMOVAL

-  REMOVE LUMINAIRE
 REMOVE LIGHT STANDARD
 REMOVE LIGHT STANDARD BASE
-  SALVAGE LIGHT STANDARD
 REMOVE LUMINAIRE
 REMOVE LIGHT STANDARD BASE
-  SALVAGE SERVICE PANEL
-  REMOVE LUMINAIRE
 SALVAGE LIGHT STANDARD

SALVAGE & REMOVAL

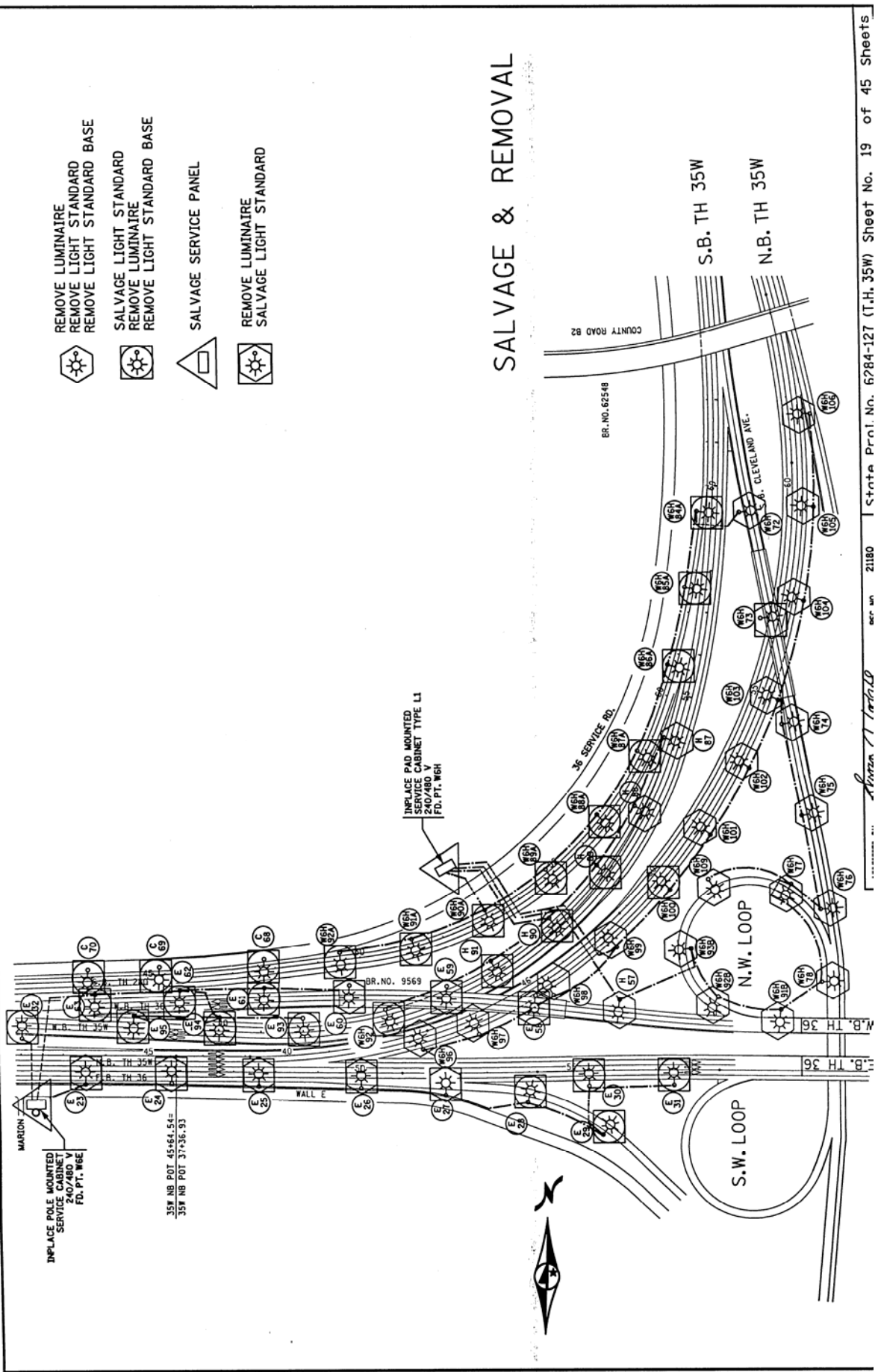

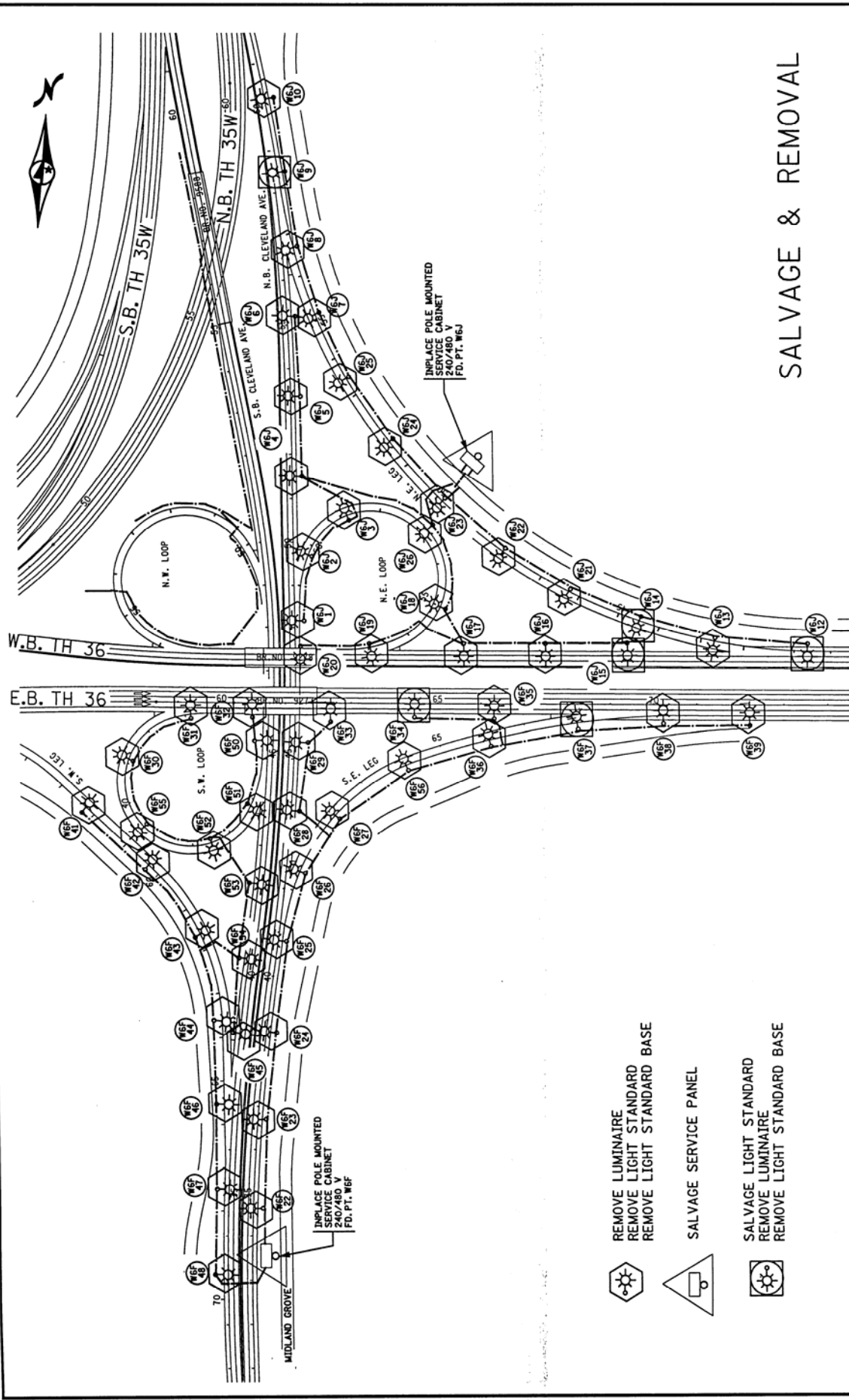

-  REMOVE LUMINAIRE
-  REMOVE LIGHT STANDARD
-  REMOVE LIGHT STANDARD BASE
-  SALVAGE SERVICE PANEL
-  SALVAGE LIGHT STANDARD
-  REMOVE LUMINAIRE
-  REMOVE LIGHT STANDARD BASE

SALVAGE & REMOVAL

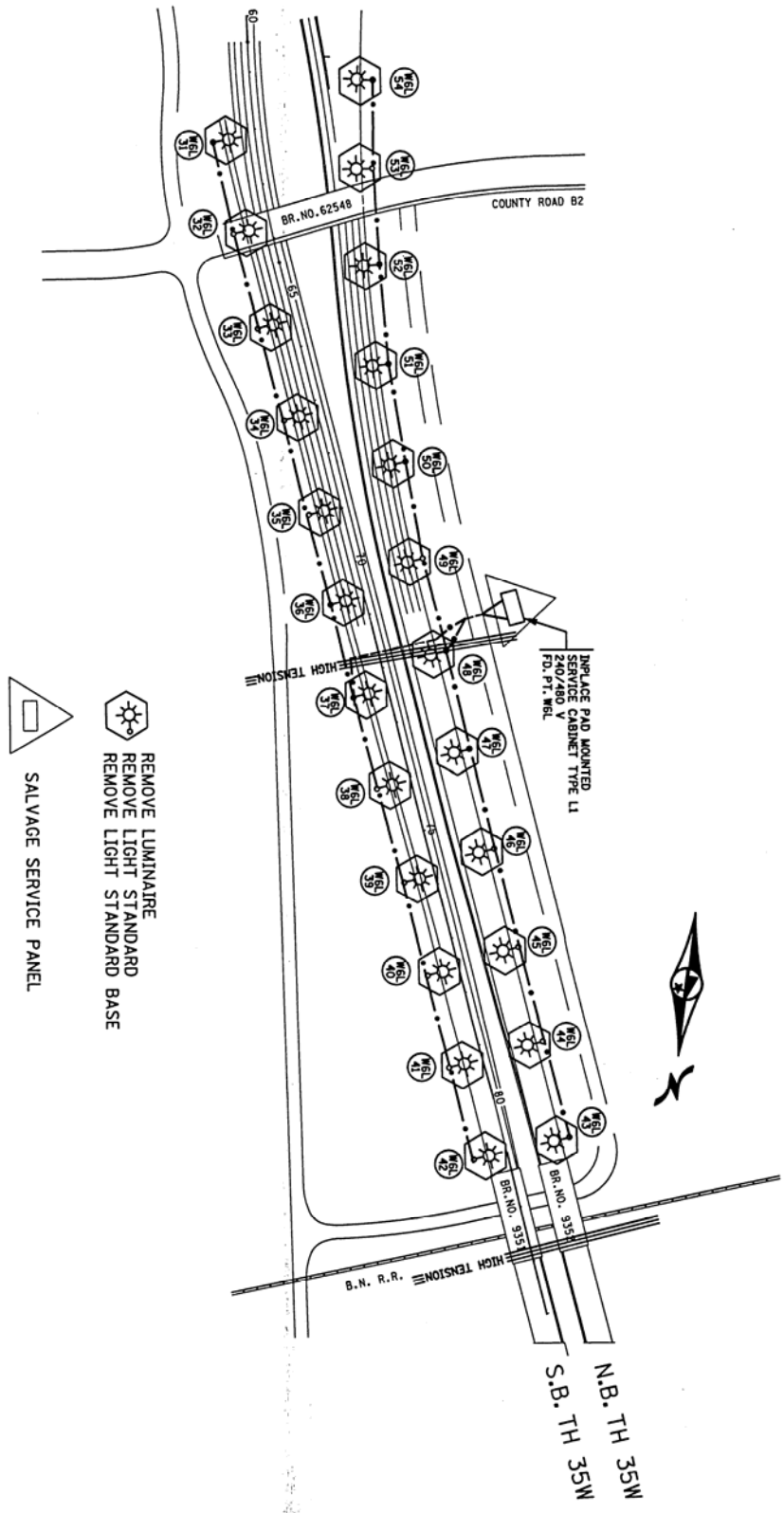

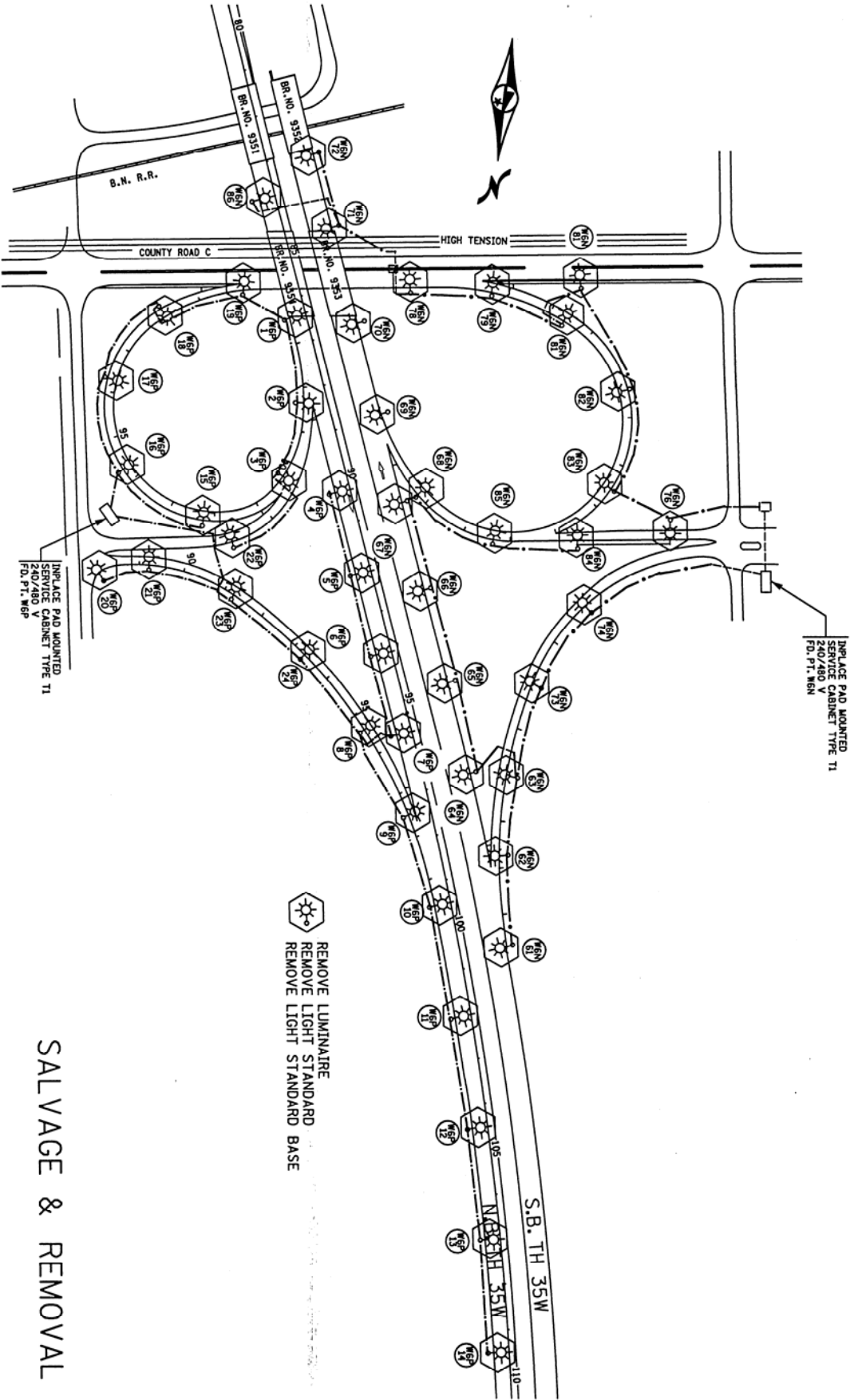

SALVAGE & REMOVAL

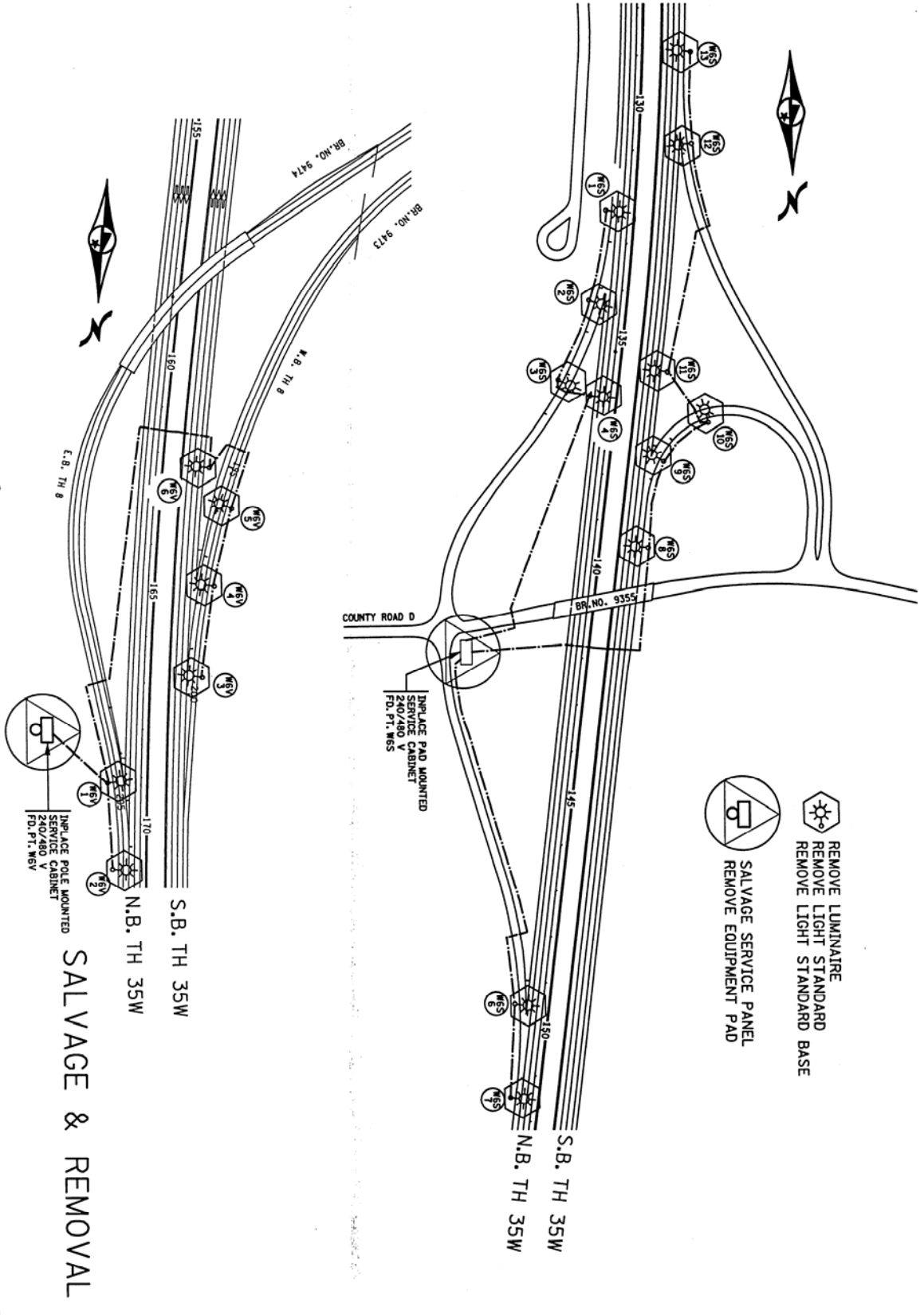

SALVAGE & REMOVAL



-  REMOVE LUMINAIRE
-  REMOVE LIGHT STANDARD BASE
-  SALVAGE SERVICE PANEL
REMOVE EQUIPMENT PAD

SALVAGE & REMOVAL

S.B. TH 35W
N.B. TH 35W

NB PT 208+11.86=
NB POT 208+09.49

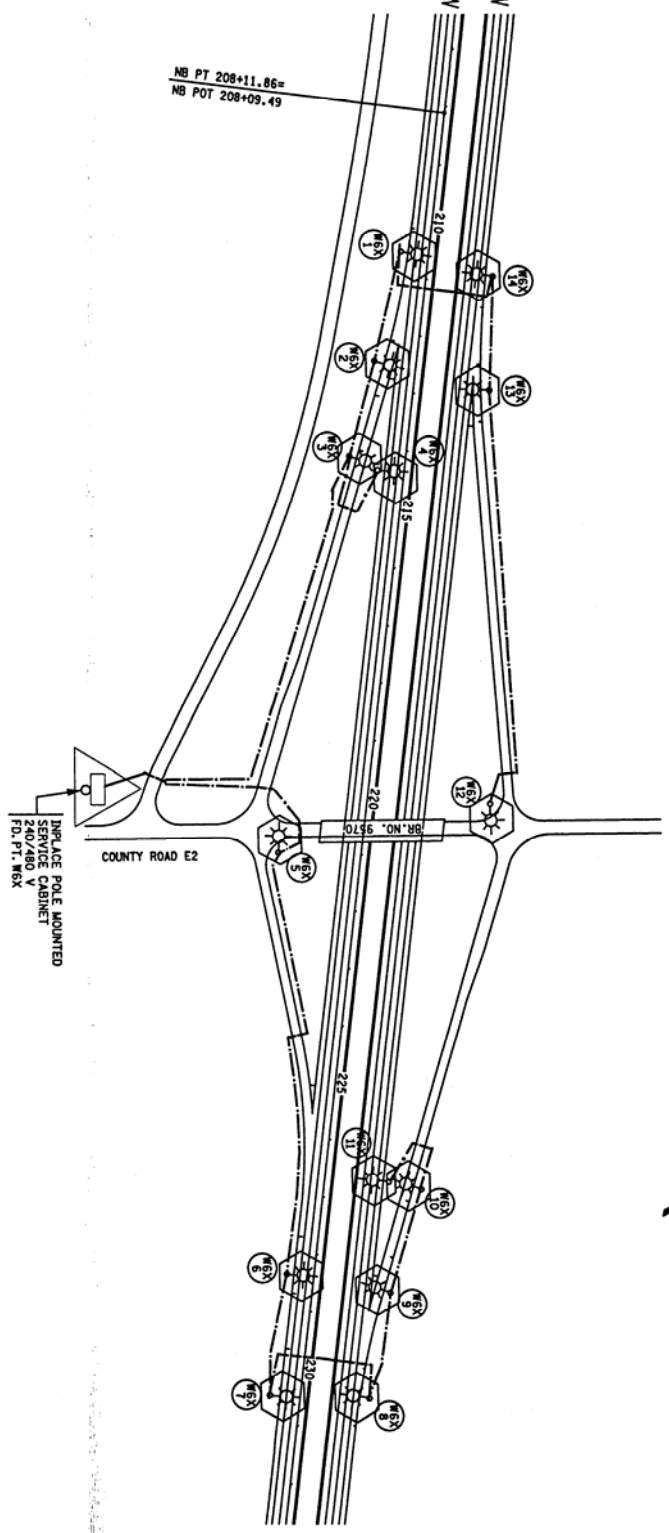

REMOVE LUMINAIRE
REMOVE LIGHT STANDARD
REMOVE LIGHT STANDARD BASE



SALVAGE SERVICE CABINET

SALVAGE & REMOVAL

LEGEND

- INPLACE PAD MOUNTED SOURCE OF POWER (240/480V.)
- PAD MOUNTED SOURCE OF POWER (240/480V.)
- ※ 250 WATT HIGH PRESSURE SODIUM LIGHTING UNIT
- ※ 250 WATT HIGH PRESSURE SODIUM TWIN MAST ARM LIGHTING UNIT
- 1000 WATT HIGH PRESSURE SODIUM HIGH MAST LIGHTING UNIT WITH 3 LUMINAIRES
- 1000 WATT HIGH PRESSURE SODIUM HIGH MAST LIGHTING UNIT WITH 4 LUMINAIRES
- INPLACE UNDERPASS LIGHTING UNIT
- ※ 250 WATT HIGH PRESSURE SODIUM UNDERPASS LIGHTING UNIT
- 3" RIGID STEEL CONDUIT EXCEPT AS NOTED OTHERWISE
- INPLACE RIGID STEEL CONDUIT
- DIRECT BURIED POWER CABLE, 3 CONDUCTOR NO. 4 AWG
- ARMORED CABLE SPEC NO. 3804 & 3805
- PULL BOX
- INPLACE PULL BOX
- |- PERMANENT GROUND ROD (25 OHMS OR LESS)
- INPLACE OVERHEAD SIGN

CONSTRUCTION NOTES

- (1) DO NOT CONNECT OVERHEAD SIGNS UNLESS SHOWN ON WIRING DIAGRAM
- (2) ABANDON ALL INPLACE CABLE, BUT REMOVE FROM CONDUIT BEING REUSED

PAD MOUNTED SOURCE OF POWER SERVICE PANEL SECONDARY TYPE L2
 FD. PT. W6C 240/480V. (UNTERRED.)
 TO TRANSFORMER ON N.S.P.P.O.
 EQUIPMENT PAD B REQUIRED

PAD MOUNTED SOURCE OF POWER SERVICE PANEL SECONDARY TYPE L1
 FD. PT. W6A 240/480V. (UNTERRED.)
 TO TRANSFORMER ON N.S.P.P.O.
 EQUIPMENT PAD B REQUIRED

PAD MOUNTED SOURCE OF POWER SERVICE PANEL SECONDARY TYPE L1
 FD. PT. W6A 240/480V. (UNTERRED.)
 TO TRANSFORMER ON N.S.P.P.O.
 EQUIPMENT PAD B REQUIRED

PAD MOUNTED SOURCE OF POWER SERVICE PANEL SECONDARY TYPE L1
 FD. PT. W6A 240/480V. (UNTERRED.)
 TO TRANSFORMER ON N.S.P.P.O.
 EQUIPMENT PAD B REQUIRED

PAD MOUNTED SOURCE OF POWER SERVICE PANEL SECONDARY TYPE L1
 FD. PT. W6A 240/480V. (UNTERRED.)
 TO TRANSFORMER ON N.S.P.P.O.
 EQUIPMENT PAD B REQUIRED

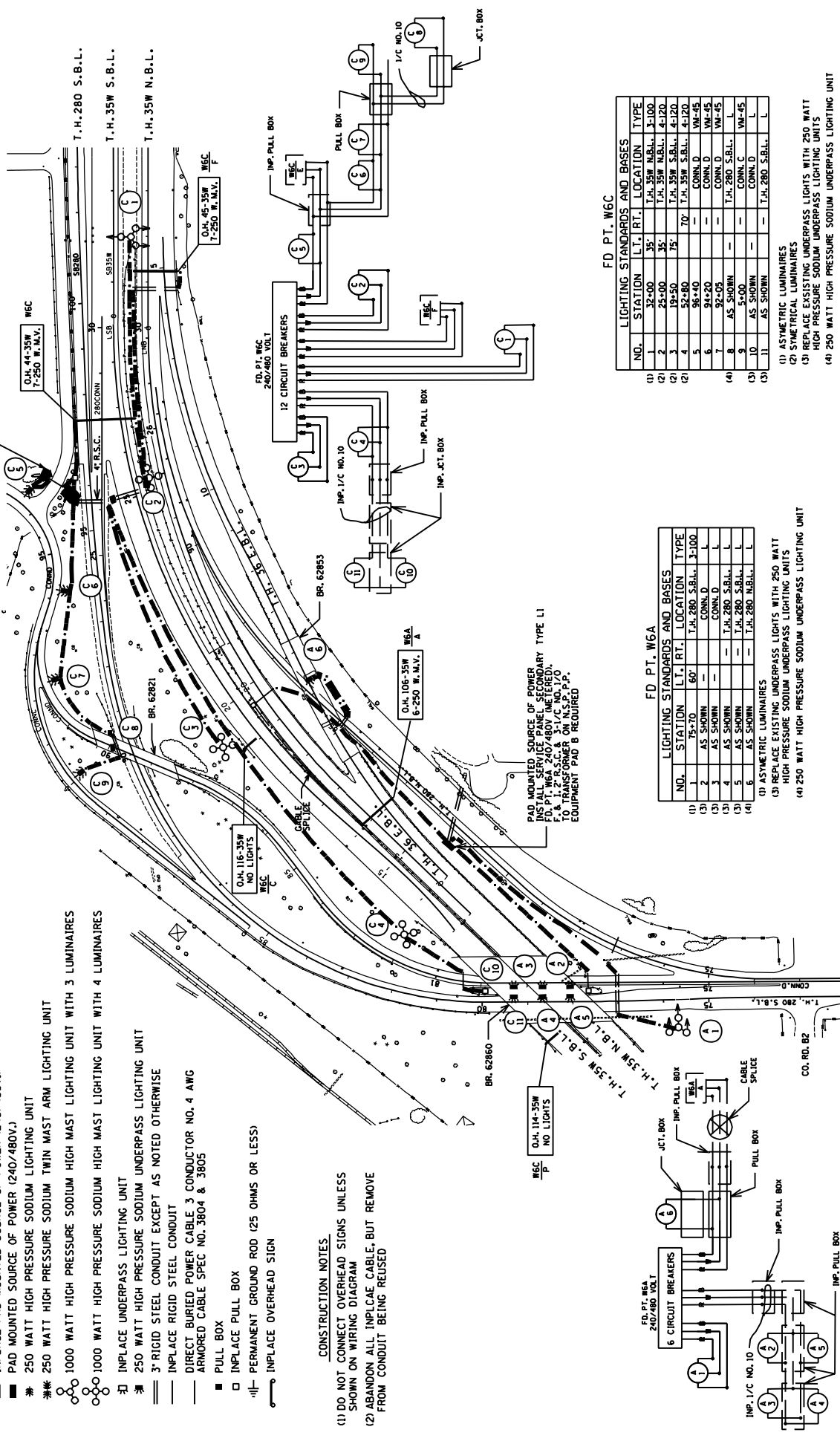

FD. PT. W6C

LIGHTING STANDARDS AND BASES			
NO.	STATION	L.T. RT.	LOCATION TYPE
(1)	32+00	35'	T.H. 35W M.B.L.L. 3-100
(2)	35+00	35'	T.H. 35W M.B.L.L. 4-120
(3)	19+50	75'	T.H. 35W S.B.L.L. 4-120
(4)	52+80	70'	T.H. 35W S.B.L.L. 4-120
(5)	96+40	—	CONN. D. VM-45
(6)	94+20	—	CONN. D. VM-45
(7)	92+05	—	CONN. D. VM-45
(8)	AS SHOWN	—	T.H. 280 S.B.L.L. L
(9)	5+00	—	CONN. C. VM-45
(10)	AS SHOWN	—	CONN. D. L
(11)	AS SHOWN	—	T.H. 280 S.B.L.L. L

- (1) ASYMETRIC LUMINAIRES
- (2) SYMETRIC LUMINAIRES
- (3) REPLACE EXISTING UNDERPASS LIGHTS WITH 250 WATT HIGH PRESSURE SODIUM UNDERPASS LIGHTING UNITS
- (4) 250 WATT HIGH PRESSURE SODIUM UNDERPASS LIGHTING UNIT

FD. PT. W6A

LIGHTING STANDARDS AND BASES			
NO.	STATION	L.T. RT.	LOCATION TYPE
(1)	75+70	60'	T.H. 280 S.B.L.L. 3-100
(2)	AS SHOWN	—	CONN. D. L
(3)	AS SHOWN	—	CONN. D. L
(4)	AS SHOWN	—	T.H. 280 S.B.L.L. L
(5)	AS SHOWN	—	T.H. 280 S.B.L.L. L
(6)	AS SHOWN	—	T.H. 280 M.B.L.L. L

- (1) ASYMETRIC LUMINAIRES
- (2) REPLACE EXISTING UNDERPASS LIGHTS WITH 250 WATT HIGH PRESSURE SODIUM UNDERPASS LIGHTING UNITS
- (3) 250 WATT HIGH PRESSURE SODIUM UNDERPASS LIGHTING UNIT
- (4) 250 WATT HIGH PRESSURE SODIUM UNDERPASS LIGHTING UNIT

FD. PT. WGH LIGHTING STANDARDS AND BASES

NO.	STATION	L.T.	RT.	LOCATION	TYPE
(2)	56+70	80'	30'	T.H. 35W S.B.L.	3-100
(2)	50+90	40'	30'	T.H. 35W N.B.L.	3-100
(2)	57+50	50'	30'	T.H. 35W W.B.L.	3-100
(2)	44+50	50'	30'	T.H. 35W N.B.L.	3-100
(2)	41+00	45'	30'	T.H. 35W S.B.L.	4-120
6	47+30	-	-	CLEVELAND S.B.	L
7	47+30	-	-	CLEVELAND N.B.	L
8	AS SHOWN	-	-	T.H. 35W N.B.L.	L
9	AS SHOWN	-	-	T.H. 35W S.B.L.	L
10	AS SHOWN	-	-	T.H. 35W N.B.L.	L

(2) SYMMETRICAL LUMINAIRES

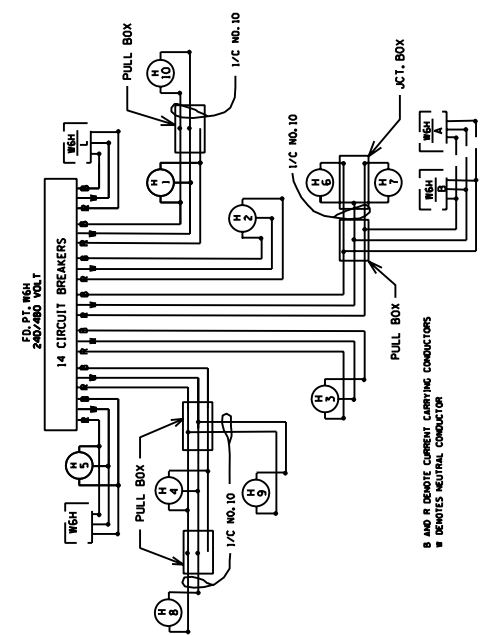

PAD MOUNTED SOURCE OF POWER
SERVICE PANEL SECONDARY TYPE L2
EQUIPMENT PAD IN PLACE

2-3" R.S.C.
2-3" RSC IMP.

B AND R DENOTE CURRENT CARRYING CONDUCTORS
DENOTES NEUTRAL CONDUCTOR

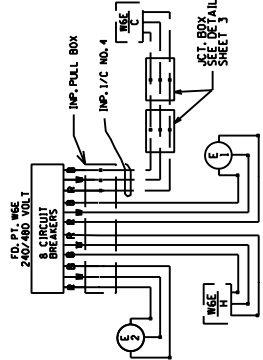
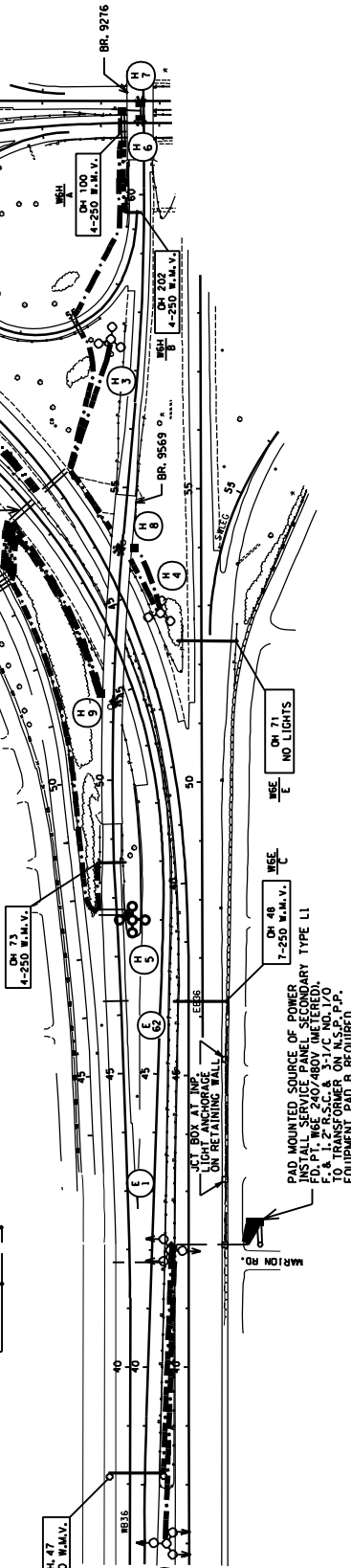

FD. PT. WGE

FD. PT. WGE LIGHTING STANDARDS AND BASES

NO.	STATION	L.T.	RT.	LOCATION	TYPE
(1)	42+00	30'	30'	T.H. 35W N.B.L.	3-100
(1)	37+00	40'	30'	T.H. 35W N.B.L.	3-100

(1) ASYMMETRICAL LUMINAIRES

PAD MOUNTED SOURCE OF POWER
INSTALL SERVICE PANEL SECONDARY TYPE L1
EQUIPMENT PAD IN PLACE
TO TRANSFORMER ON N.S.P.P.

FD. PT. WGE
E NO. LIGHTS

B AND R DENOTE CURRENT CARRYING CONDUCTORS
DENOTES NEUTRAL CONDUCTOR

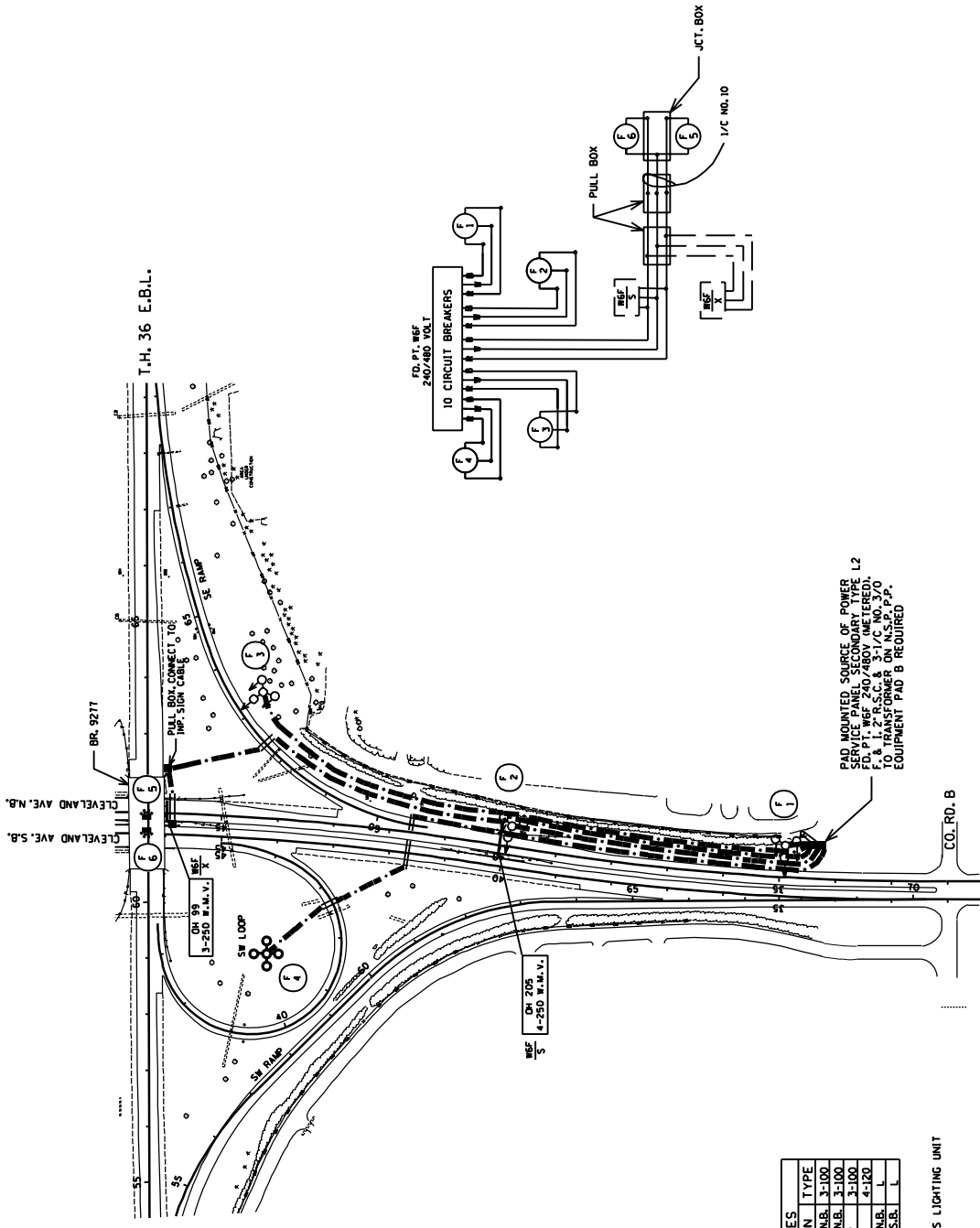

FD. PT. W6F

LIGHTING STANDARDS AND BASES		
NO.	STATION	L.I. RT. LOCATION TYPE
(1)	34+80	45' CLEVELAND N.B. 3-100
(1)	39+80	40' CLEVELAND N.B. 3-100
(1)	63+50	42' S.E. RAMP 3-100
(2)	58+10	215' S.W. LOOP 4-120
(3)	46+35	— CLEVELAND N.B. L
(3)	46+35	— CLEVELAND S.B. L

- (1) ASYMETRIC LUMINAIRES
- (2) SYMMETRICAL LUMINAIRES
- (3) 200 WATT HIGH PRESSURE SODIUM UNDERPASS LIGHTING UNIT

PAD MOUNTED SOURCE OF POWER
 TO BE PROVIDED BY THE
 OWNER. THE SOURCE OF POWER
 TO BE PROVIDED BY THE OWNER
 TO TRANSFORMER ON N.S.P.P.P.
 EQUIPMENT PAD B REQUIRED

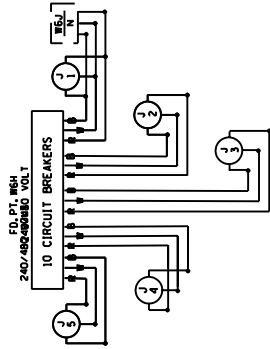

FD PT. W6J

NO.	STATION	L.T. RT.	LOCATION	TYPE
(1)	72+10	55'	T.H. 36 N.B.L.	3-100
(2)	67+10	70'	T.H. 36 W.B.L.	3-100
(3)	48+00	75'	CLEVELAND N.B.	4-120
(4)	52+80	70'	CLEVELAND N.B.	3-100
(5)	61+24	50'	T.H. 35W S.B.L.	3-100

- (1) ASYMETRIC LUMINAIRES
- (2) SYMETRIC LUMINAIRES

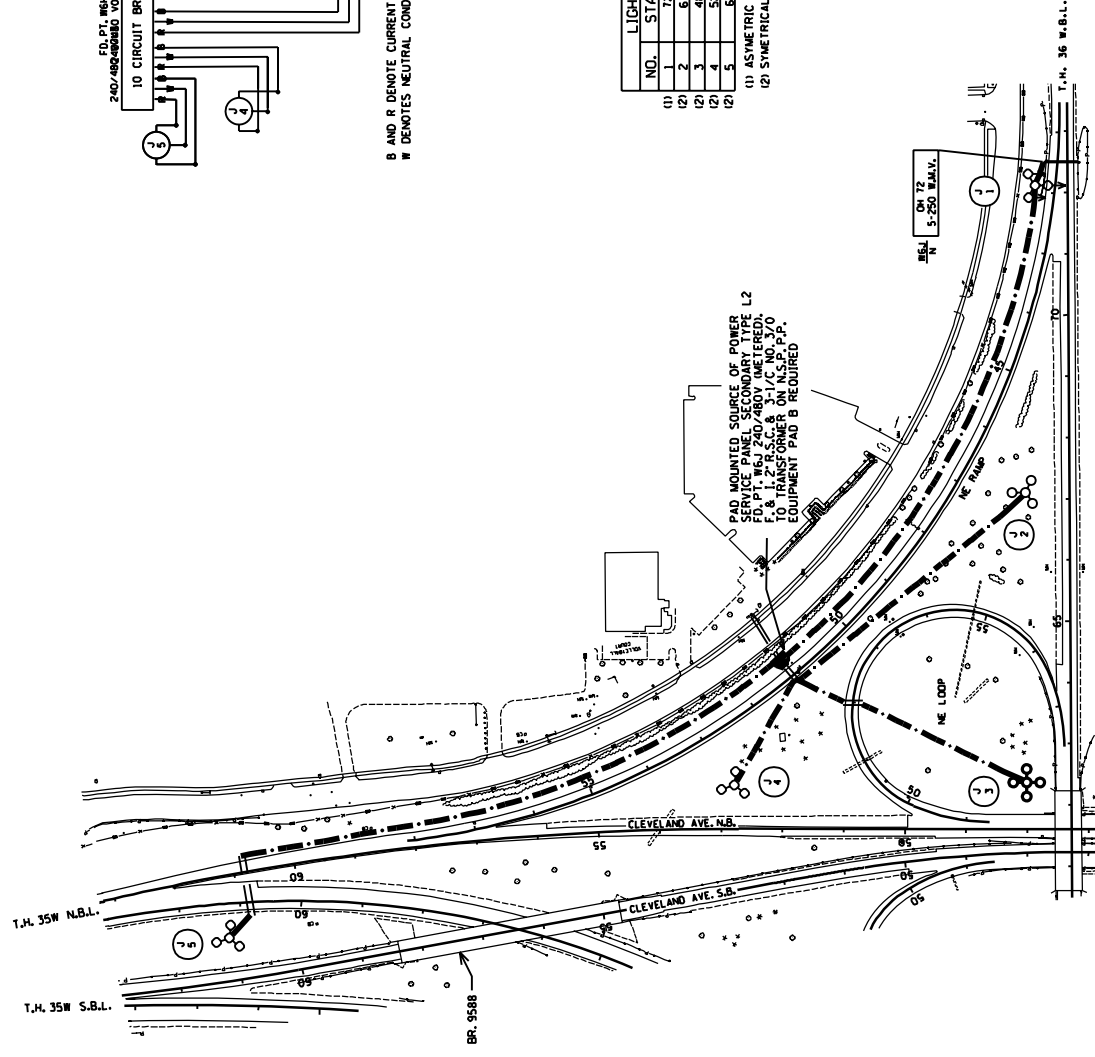

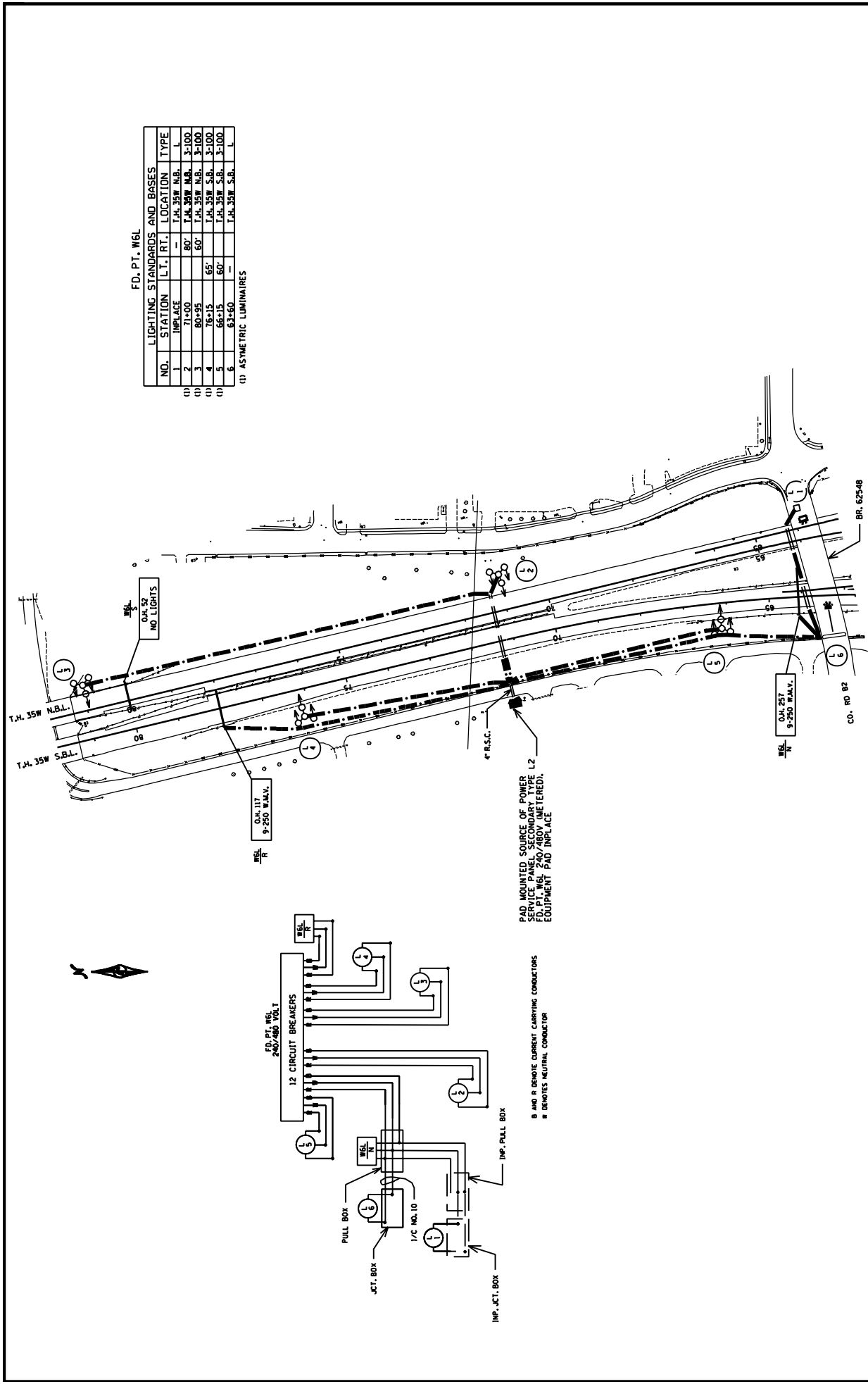

FD, PT, W6L

LIGHTING STANDARDS AND BASES			
NO.	STATION	L.T. RT.	LOCATION TYPE
1	IMPLAC	—	T.H. 35W N.B. L
2	71+00	80'	T.H. 35W N.B. 3-100
3	80+95	60'	T.H. 35W S.B. 3-100
4	78+15	65'	T.H. 35W S.B. 3-100
5	68+15	50'	T.H. 35W S.B. 3-100
6	62+60	—	T.H. 35W S.B. L

(1) ASYMMETRIC LUMINAIRES

PAD MOUNTED SOURCE OF POWER
SERVICE PANEL SECONDARY TYPE L2
FD, PT, W6L 240/480V METERED
EQUIPMENT PAD IMPLAC

B INDICATES CURRENT CARRYING CONDUCTORS
R INDICATES NEUTRAL CONDUCTOR

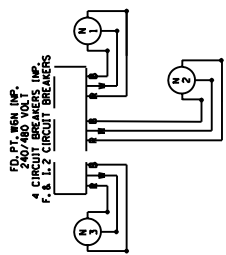

FD. PT. W6N IMP.
240/480 VOLT
4 CIRCUIT BREAKERS IMP.
F, L, Z CIRCUIT BREAKERS
N, Z

FD. PT. W6N

LIGHTING STANDARDS AND BASES			
NO.	STATION	L.T. RT.	LOCATION TYPE
(1)	86+75	80'	L.H. 35W. N.B. 3-100
(2)	84+20	70'	L.H. 35W. N.B. 3-100
(3)	82+22	170'	CO. RD. C 3-100

(1) SYMMETRICAL LUMINAIRES
(2) SYMMETRICAL LUMINAIRES

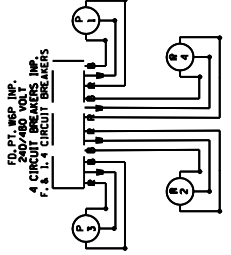

FD. PT. W6P IMP.
240/480 VOLT
4 CIRCUIT BREAKERS IMP.
F, L, Z CIRCUIT BREAKERS
N, Z

FD. PT. W6P

LIGHTING STANDARDS AND BASES			
NO.	STATION	L.T. RT.	LOCATION TYPE
(2)	86+80	80'	L.H. 35W. N.B. 4-120
(2)	92+15	80'	L.H. 35W. N.B. 3-100
(1)	101+35	75'	L.H. 35W. N.B. 3-100
(2)	93+70	45'	N.E. CONN. 3-100

(1) ASYMMETRICAL LUMINAIRES
(2) SYMMETRICAL LUMINAIRES

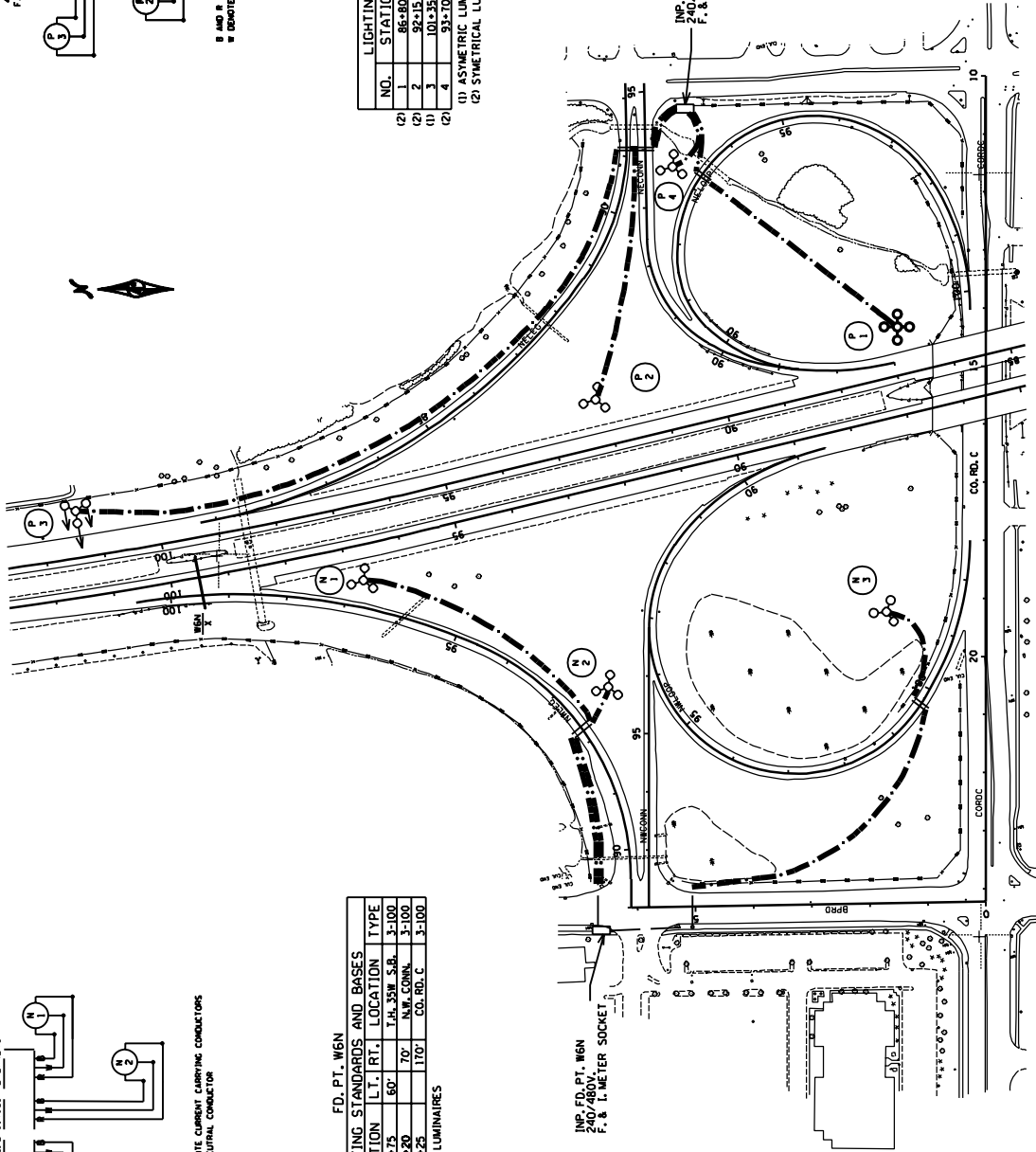

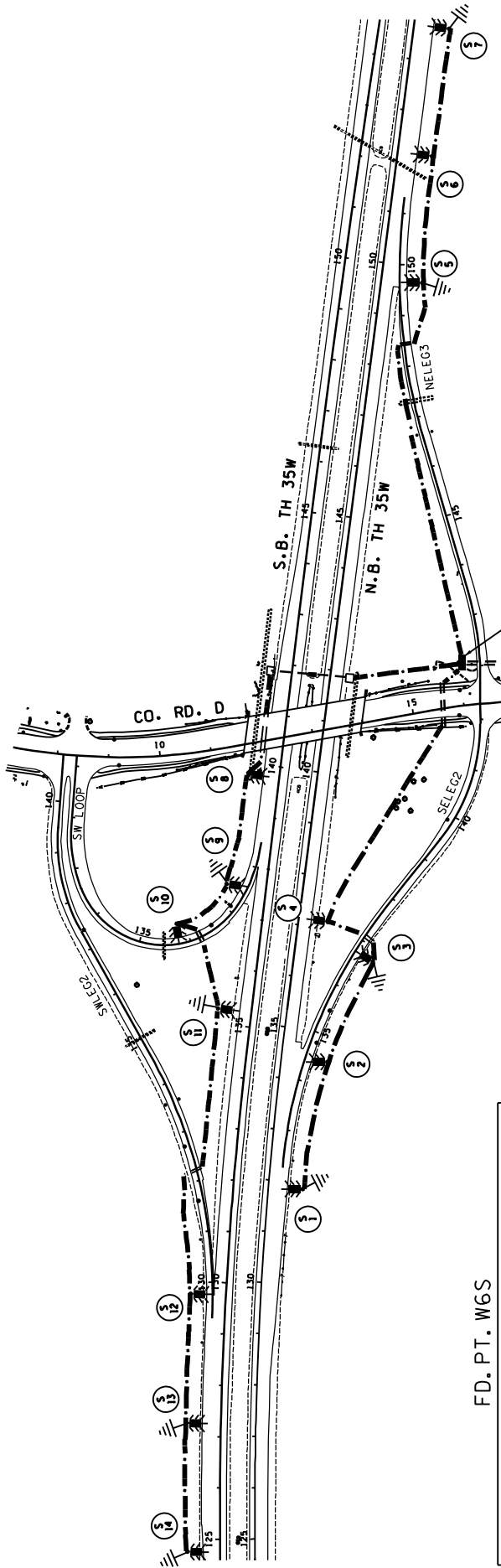

FD. PT. W6S

LIGHTING STANDARDS AND BASES				
NO.	STATION	L.T. RT.	LOCATION	TYPE
1	131+86	---	TH 35W N.B.	VM-45
2	134+40	---	TH 35W N.B.	VM-45
3	136+55	---	TH 35W N.B.	VM-45
4	137+13	---	TH 35W N.B.	VM-45
5	149+67	---	TH 35W N.B.	VM-45
6	152+17	---	TH 35W N.B.	VM-45
7	154+67	---	TH 35W N.B.	VM-45
8	139+79	---	TH 35W S.B.	VM-45
9	137+59	---	TH 35W S.B.	VM-45
10	134+23	---	S.W. LOOP	VM-45
11	135+29	---	TH 35W S.B.	VM-45
12	129+75	---	TH 35W S.B.	VM-45
13	127+25	---	TH 35W S.B.	VM-45
14	124+75	---	TH 35W S.B.	VM-45

SEE SHEET 10 FOR PLACEMENT OF LIGHTING UNITS

PAD MOUNTED SOURCE OF POWER
 SERVICE CABINET SECONDARY TYPE L1
 240/480 VOLT, FD. PT. W6S
 F.A. 1.2" R.S.C. & 3-1/2" NO. 1/0
 TO TRANSFORMER ON IMP. N.S.P. P.P.
 EQUIPMENT PAD B REQUIRED

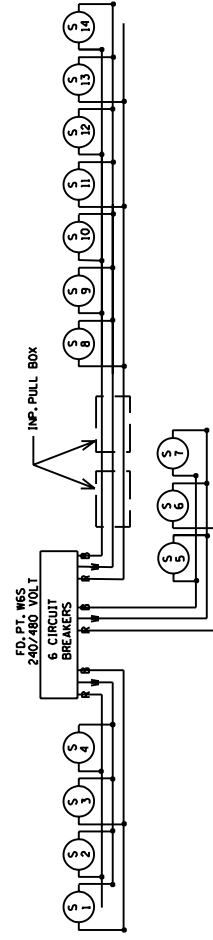

B AND R DENOTE CURRENT CARRYING CONDUCTORS
 W DENOTES NEUTRAL CONDUCTOR

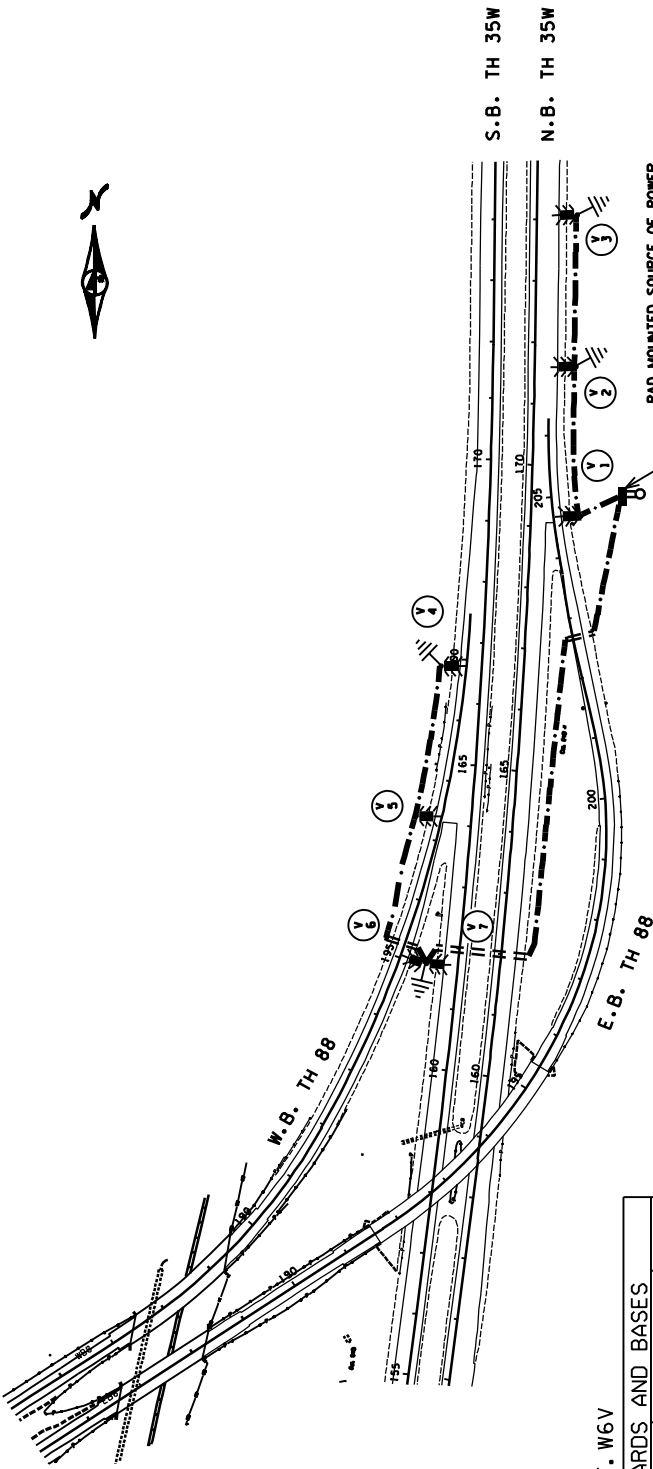

FD. PT. W6V

LIGHTING STANDARDS AND BASES				
NO.	STATION	LT. RT.	LOCATION	TYPE
1	169+17	---	TH 35W N.B.	VM-45
2	171+61	---	TH 35W N.B.	VM-45
3	174+07	---	TH 35W N.B.	VM-45
4	166+59	---	TH 35W S.B.	VM-45
5	164+10	---	TH 35W S.B.	VM-45
6	161+70	---	TH 35W S.B.	VMD-45
7				

(1) PLACE MIDPOINT BETWEEN RAMP AND MAINLINE
SEE SHEET 10 FOR PLACEMENT OF LIGHTING UNITS

PAD MOUNTED SOURCE OF POWER
SERVICE CABINET SECONDARY TYPE L1
240/480 VOLT, FD. PT. W6V
F & 1 1/2" R.S.C. & 3-1/2" NO. 170
TO TRANSFORMER ON IMP. N.S.P. P.P.
EQUIPMENT PAD B REQUIRED

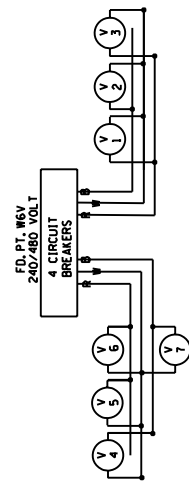

B AND R DENOTE CURRENT CARRYING CONDUCTORS
W DENOTES NEUTRAL CONDUCTOR

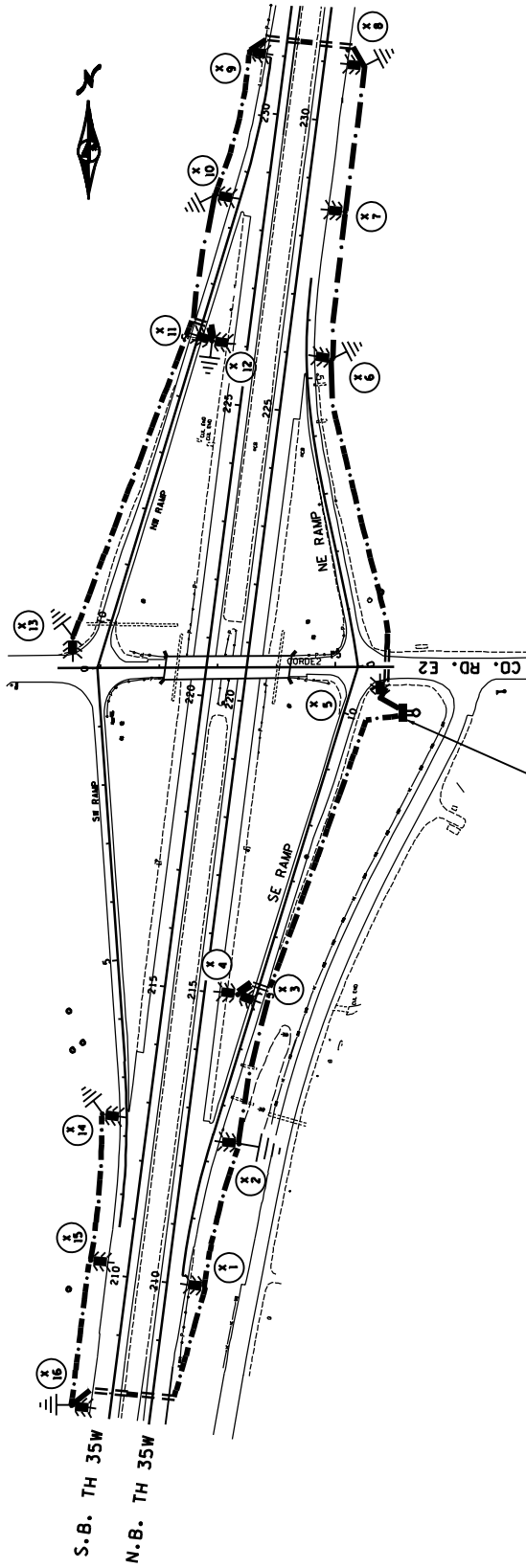

PAD MOUNTED SOURCE OF POWER
 SERVICE CABINET SECONDARY TYPE L1
 240/480 VOLT, FD, PT, W6X
 F & 1 1/2" R.S.C. & 3-1/4" NO. 1/0
 TO TRANSFORMER ON IMP. N.S.P. P.P.
 EQUIPMENT PAD B REQUIRED

FD, PT, W6X

LIGHTING STANDARDS AND BASES				
NO.	STATION	L.T. RT.	LOCATION	TYPE
1	210+00	---	TH 35W N.B.	VM-45
2	212+50	---	TH 35W N.B.	VM-45
3	214+90	---	TH 35W N.B.	VMD-45
4	10+48	---	S.E. RAMP	VM-45
5	226+00	---	TH 35W N.B.	VM-45
6	228+50	---	TH 35W N.B.	VM-45
7	231+00	---	TH 35W N.B.	VM-45
8	231+00	---	TH 35W S.B.	VM-45
9	228+50	---	TH 35W S.B.	VM-45
10	226+10	---	TH 35W S.B.	VMD-45
11	10+45	---	N.W. RAMP	VM-45
12	212+70	---	TH 35W S.B.	VM-45
13	210+20	---	TH 35W S.B.	VM-45
14	207+70	---	TH 35W S.B.	VM-45

(1) PLACE MIDPOINT BETWEEN RAMP AND MAINLINE
 SEE SHEET 10 FOR PLACEMENT OF LIGHTING UNITS

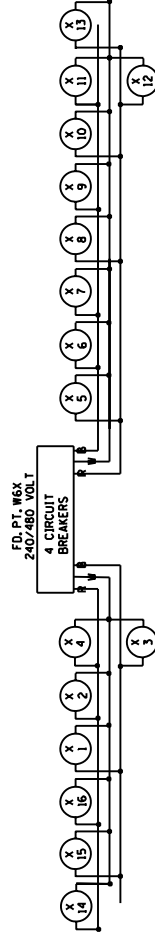

B AND R DENOTE CURRENT CARRYING CONDUCTORS
 # DENOTES NEUTRAL CONDUCTOR

TRAFFIC CONTROL PAY ITEM TABULATION SHEET

ITEM	UNIT	QUANTITY
CONCRETE MEDIAN BARRIER DESIGN 8337	LIN. FT.	2020
IMPACT ATTENUATOR BARRELS	EACH	26
CONNECTING PINS	EACH	198
MEDIAN BARRIER DELINEATOR	EACH	68



NO SHOULDER

ROAD WORK AHEAD

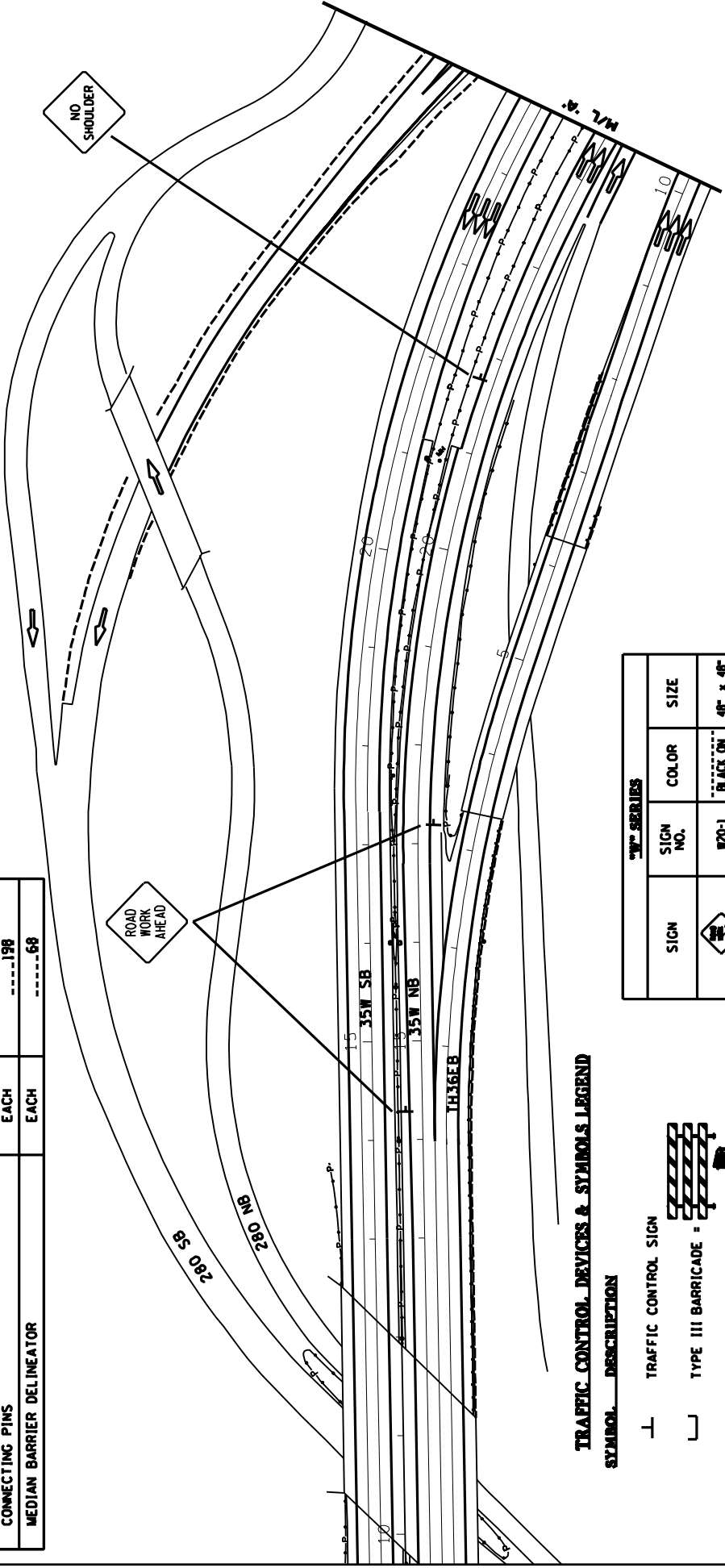

TRAFFIC CONTROL DEVICES & SYMBOLS LEGEND

SYMBOL DESCRIPTION

- ⊥ TRAFFIC CONTROL SIGN
- ┌ TYPE III BARRICADE =
- DRUM-LIKE CHANNELIZER =
- CONCRETE BARRIER WITH DELINEATORS AT 30' SPACES

TYPE SERIES			
SIGN	SIGN NO.	COLOR	SIZE
	W21-1	BLACK ON ORANGE	48" x 48"
	W21-31	BLACK ON YELLOW	48" x 48"

TRAFFIC CONTROL SYMBOLS

TRAFFIC CONTROL

SCALE 100'

CERTIFIED BY _____ REG NO 11940 _____ 20 _____

STATE PROJ NO 6284-127 (I-H-35W) SHEET NO 34 OF 38 SHEETS

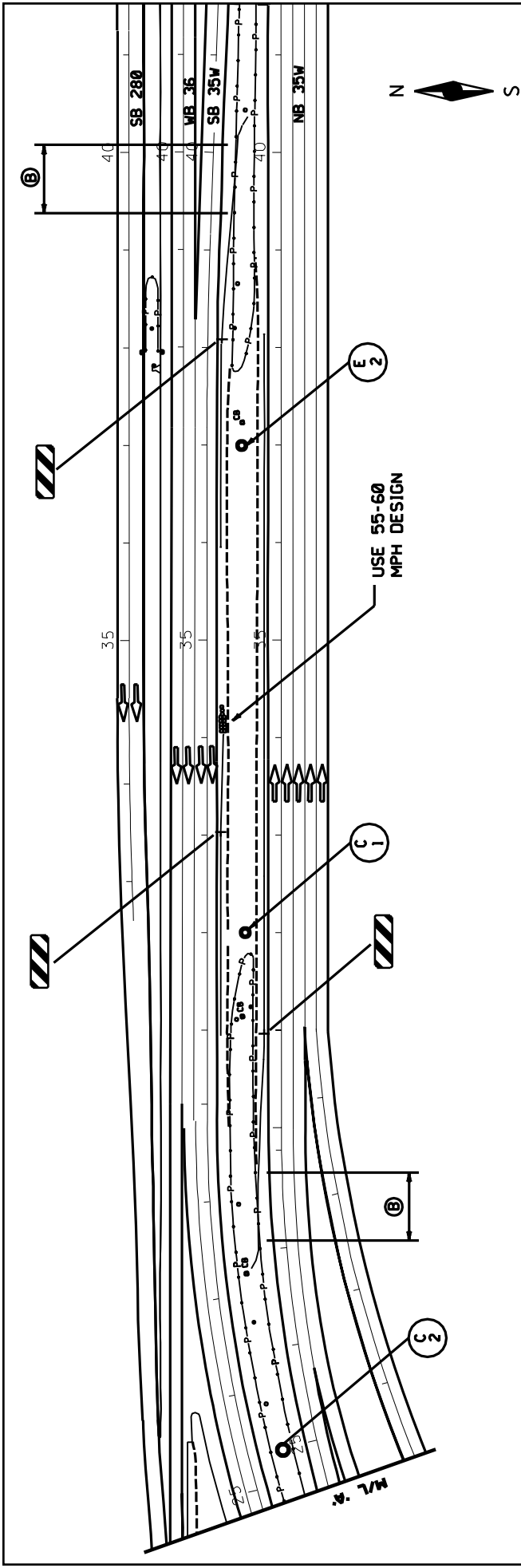

ⓔ REMOVE SECTIONS OF INPLACE PLATE BEAM GUARDRAIL AND RUN END OF PPCB BEHIND GUARD RAIL. THIS WILL BE INCIDENTAL WORK FOR WHICH NO DIRECT COMPENSATION WILL BE MADE.

BARRIER & DELINEATION:

TOP MOUNTED BARRIER DELINEATORS WILL HAVE A MINIMUM OF 24 SQ. IN. OF REFLECTIVE SURFACE AREA AND BE PLACED AT 30' SPACES ON TOP OF THE BARRIER WHEN THE BARRIER IS WITHIN 10' OF TRAFFIC UNLESS OTHERWISE NOTED OR AS DIRECTED BY THE ENGINEER. IF THE TRAFFIC ENGINEER REQUIRES SIDE MOUNTED BARRIER DELINEATORS, THEY WILL HAVE A MINIMUM OF 12 SQ. IN. OF REFLECTIVE SURFACE AREA AND BE PLACED AT 30' SPACES. IF A SMALLER APPROVED BARRIER DELINEATOR IS USED IT SHALL BE AT ONE HALF THE SPACING AND ONE HALF THE BID PRICE.

NOTE: SEE TYPICAL SHEET FOR DETAILS

SCALE 100'

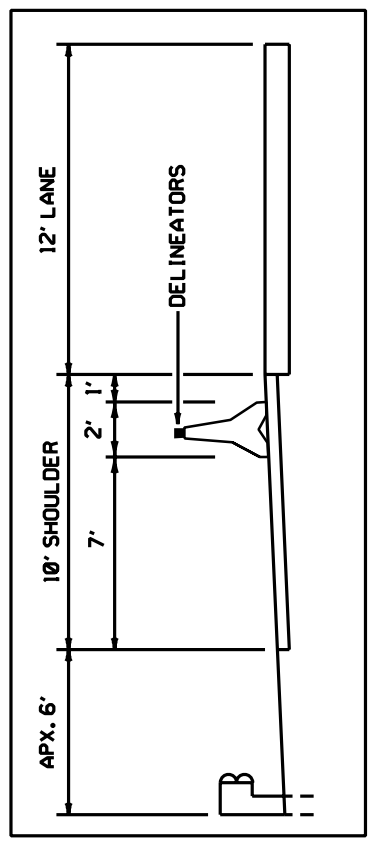

TRAFFIC CONTROL SHEET NO.	1146
	-2
TRAFFIC CONTROL	



SEE 6K-75
OF HANDBOOK

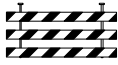

Ⓐ

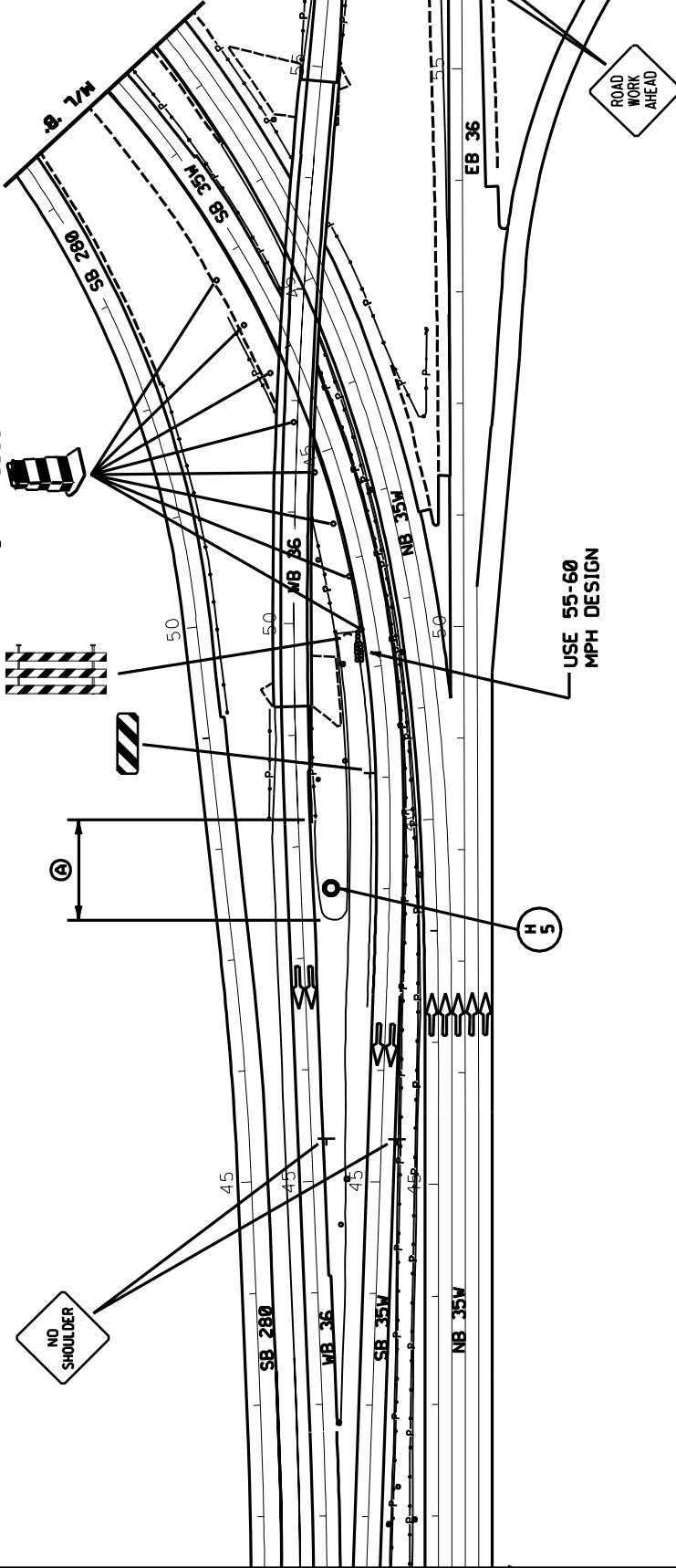

USE 55-60
MPH DESIGN

H
5

Ⓐ INSTALL PROPOSED GUARDRAIL
ON NORTH SIDE OF W.B. T.H. 36
BEFORE CONSTRUCTING TOWER

SCALE 1" = 100'

PROJECT NUMBER (SEE 1.04)	1146
SHEET NO.	3
STATE PROJ NO	6284-127 (I.H. 35W)
SHEET NO	36 OF 45 SHEETS

NOTE: SEE TYPICAL SHEET FOR DETAILS

CERTIFIED BY _____ REG NO 11940 _____ 20____

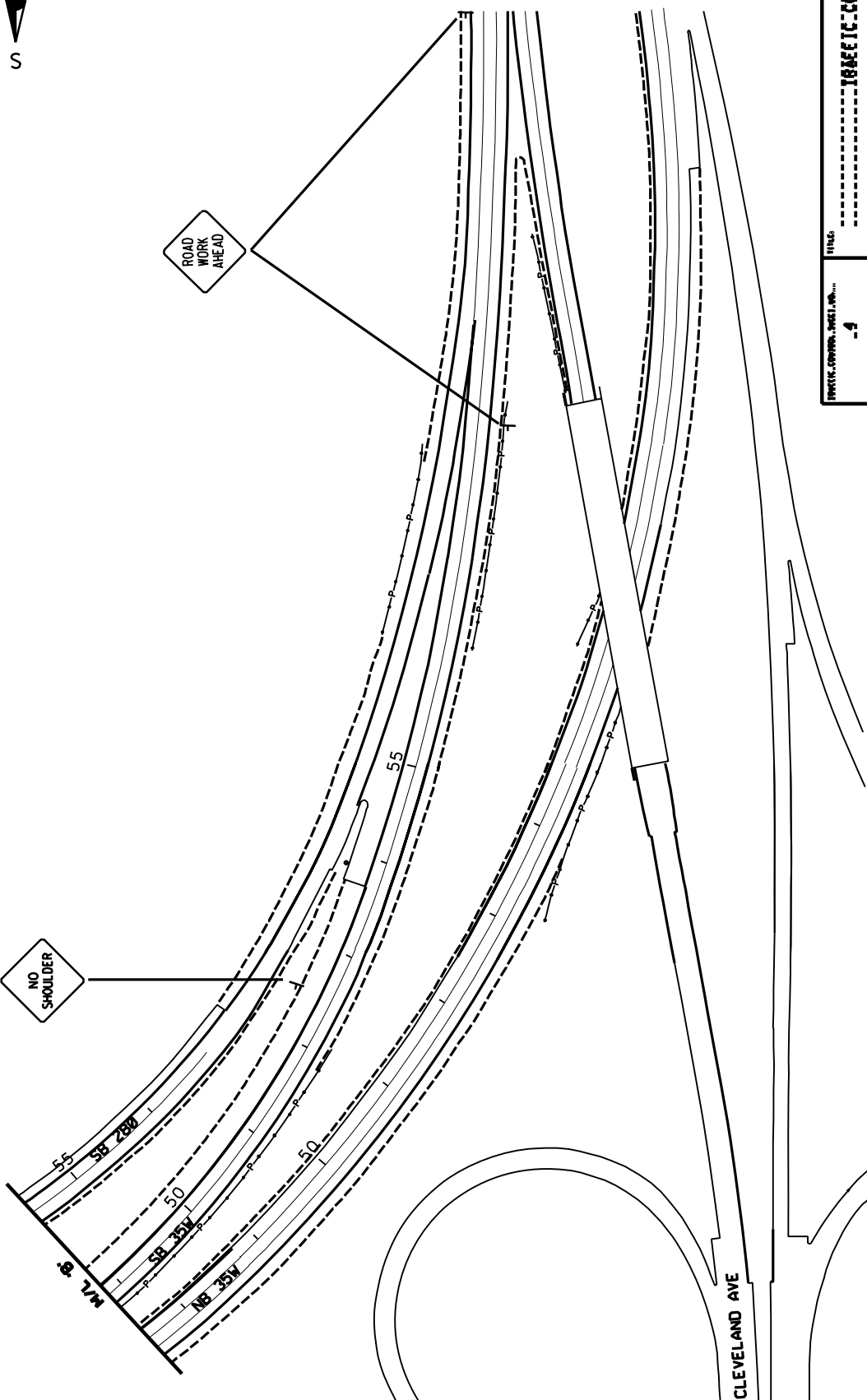

SCALE 100'

PROJECT NUMBER SHEET NO. 4

TRAFFIC CONTROL

CERTIFIED BY _____ REG NO 11940 _____ 20 _____

STATE PROJ NO 6284-127-11-H-35W1.. SHEET NO 37 OF 45 SHEETS

PORTABLE CONCRETE BARRIER PLACEMENT

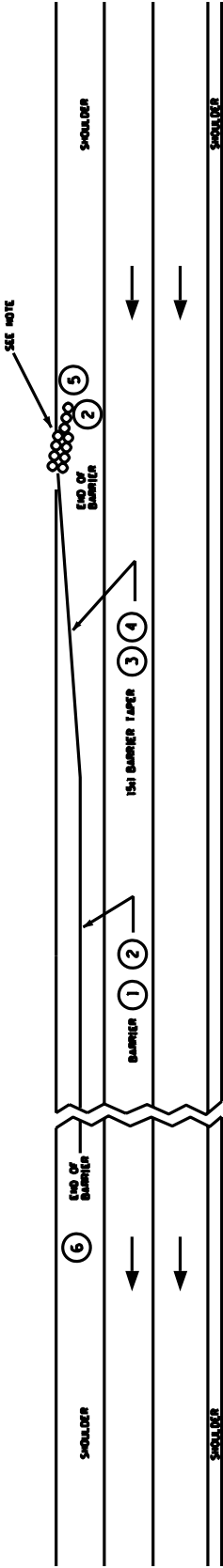

1 IT IS DESIRABLE TO MAINTAIN FULL SHOULDER WIDTH WHENEVER POSSIBLE. IF NOT POSSIBLE, MINIMUM DESIRABLE LATERAL OFFSETS ARE BASED ON THE FOLLOWING POSTED SPEEDS:

- 65 MPH - 10 FEET
- 60 MPH - 8 FEET
- 50 MPH - 6.5 FEET
- 40 MPH - 5 FEET

FOR RESTRICTED CONDITIONS, LESSER OFFSETS MAY BE USED. THE OFFSETS SHOULD BE A MINIMUM OF 2 FEET UNLESS THE CONDITIONS ARE EXTREME. LATERAL OFFSETS ARE MEASURED TO THE BOTTOM OF THE BARRIER. BARRIER OFFSET FROM EDGE OF THRU LANE SHOULD NOT EXCEED 15 FEET.

SAND FILLED BARREL ARRANGEMENT

NUMBERS INDICATE STANDARD MODULE WEIGHTS IN POUNDS.

POSTED SPEED: 70 MPH



POSTED SPEED: 65 MPH



POSTED SPEED: 35-40 MPH



POSTED SPEED: 55-60 MPH



POSTED SPEED: 30 MPH (OPTIONAL)



POSTED SPEED: 45-50 MPH



POSTED SPEED: 30 MPH RESTRICTED SPACE ONLY (OPTIONAL)



2 USE A 2100 POUND DRUM FOR ENERGITE SYSTEM AND A 1400 POUND DRUM FOR A FITCH SYSTEM.

2 DESIRABLE TREATMENTS FOR EXPOSED BARRIER ENDS ARE: A CONNECTION TO EXISTING BARRIER; IMPACT ATTENUATOR; TAPER AWAY TO THE EDGE OF THE CLEAR ZONE; AND EXTENDING THROUGH A PLATE BEAM GUARDRAIL BY REMOVING A PANEL.

FOR POSTED SPEEDS 30 MPH OR LESS, THE TAPERING AWAY FROM THE TRAFFIC IS DESIRABLE AND USE OF IMPACT ATTENUATOR ARE OPTIONAL.

3 A 10:1 TAPER MAY BE USED WHEN POSTED SPEED LIMIT IS 35 MPH OR LESS.

4 IF THE BARRIER IS TO BE EXTENDED BEYOND THE SHOULDER, ADDITIONAL FILL WILL BE NEEDED IN ORDER TO PROVIDE A FLAT (10:1) APPROACH AREA TO THE BARRIER. FILL WILL BE INCIDENTAL TO BARRIER AND/OR IMPACT ATTENUATOR. (SEE SHOULDER FILL DETAIL BELOW)

5 THE IMPACT ATTENUATOR SHOULD BE OFFSET A MINIMUM OF 2 FT. FROM THE EDGE OF THE THRU LANE (SEE SAND BARREL OFFSET DETAIL). THE IMPACT ATTENUATOR SHOULD BE ORIENTED TO ACCOMMODATE THE PROBABLE IMPACT ANGLE OF AN ENCRUISING VEHICLE. FOR MOST ROADSIDE CONDITIONS, AN ANGLE APPROXIMATELY TO DEGREES, AS MEASURED BETWEEN THE HIGHWAY AND THE IMPACT ATTENUATOR LONGITUDINAL CENTERLINE, IS CONSIDERED APPROPRIATE (SEE SHOULDER FILL DETAIL). FOR SAND BARREL ARRANGEMENT SEE DETAIL BELOW.

6 FOR TWO-LANE TWO-WAY TRAFFIC BOTH ENDS OF THE BARRIER SHOULD BE TREATED IN THE SAME MANNER AS DESCRIBED IN 2

NOTES

AT THE DIRECTION OF THE ENGINEER, OTHER APPROVED IMPACT ATTENUATORS CAN BE SUBSTITUTED IN LIEU OF THE SAND BARRELS ESPECIALLY WHERE REDIRECTION IS DESIRED OR AT WIDTH RESTRICTED AREAS.

SAND FILLED BARREL OFFSET

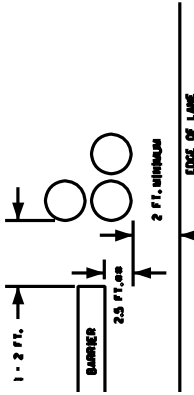

*** DISTANCE MAY BE REDUCED TO MINIMUM OF 15 IN. (1.25 FT.). THIS IS ACCEPTABLE ONLY WHERE A GREATER OFFSET WOULD CAUSE UNACCEPTABLE INTERFERENCE WITH TRAFFIC.

SHOULDER FILL

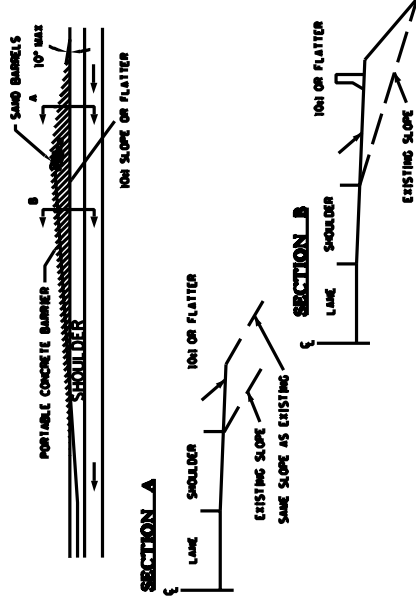

PROJECT NUMBER: 62895-127.11-A.3571
 TITLE: PORTABLE CONCRETE BARRIER END TREATMENT

CERTIFIED BY _____ REG NO 11940 _____ 20 _____

STATE PROJ NO 62895-127.11-A.3571 SHEET NO 38 OF 45 SHEETS

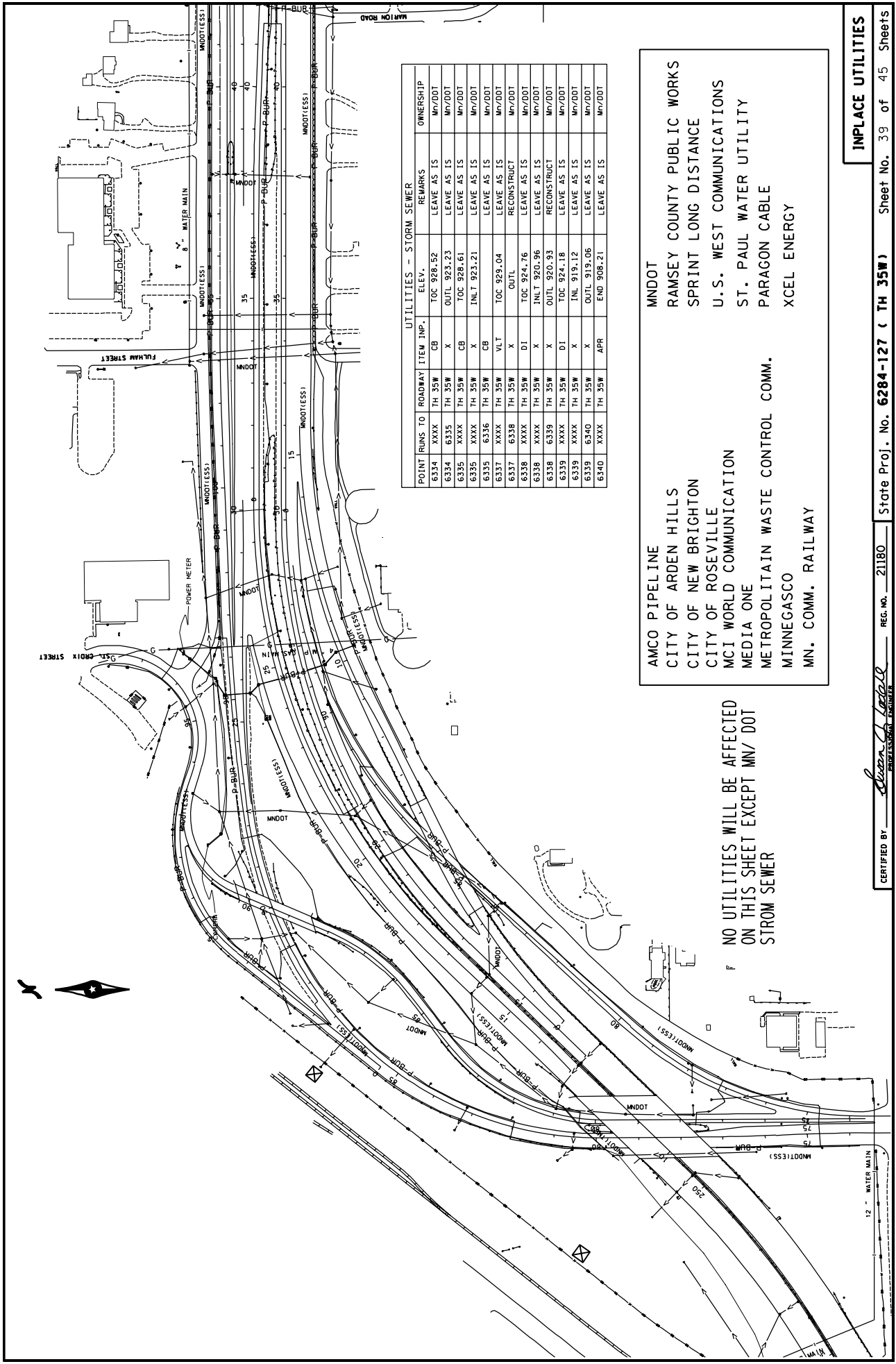

POINT	RUNS TO	ROADWAY	ITEM	IMP.	ELEV.	REMARKS	OWNERSHIP
6334	XXXX	TH 35W	CB	X	TOC 928.52	LEAVE AS IS	MN/DDT
6334	6335	TH 35W	X	X	OUTL 923.23	LEAVE AS IS	MN/DDT
6335	XXXX	TH 35W	CB	X	TOC 928.61	LEAVE AS IS	MN/DDT
6335	XXXX	TH 35W	X	X	INLT 923.21	LEAVE AS IS	MN/DDT
6335	6336	TH 35W	CB	X	TOC 929.04	LEAVE AS IS	MN/DDT
6337	XXXX	TH 35W	VLT	X	OUTL	RECONSTRUCT	MN/DDT
6338	XXXX	TH 35W	D1	X	TOC 924.76	LEAVE AS IS	MN/DDT
6338	XXXX	TH 35W	X	X	INLT 920.96	LEAVE AS IS	MN/DDT
6339	6339	TH 35W	X	X	OUTL 920.93	RECONSTRUCT	MN/DDT
6339	XXXX	TH 35W	D1	X	TOC 924.18	LEAVE AS IS	MN/DDT
6339	XXXX	TH 35W	X	X	INL 919.12	LEAVE AS IS	MN/DDT
6339	6340	TH 35W	X	X	OUTL 919.06	LEAVE AS IS	MN/DDT
6340	XXXX	TH 35W	APR	X	END 908.21	LEAVE AS IS	MN/DDT

UTILITIES - STORM SEWER

- | | |
|-----------------------------------|----------------------------|
| AMCO PIPELINE | MNDOT |
| CITY OF ARDEN HILLS | RAMSEY COUNTY PUBLIC WORKS |
| CITY OF NEW BRIGHTON | SPRINT LONG DISTANCE |
| CITY OF ROSEVILLE | U.S. WEST COMMUNICATIONS |
| MCI WORLD COMMUNICATION | ST. PAUL WATER UTILITY |
| MEDIA ONE | PARAGON CABLE |
| METROPOLITAIN WASTE CONTROL COMM. | XCEL ENERGY |
| MINNEGASCO | |
| MN. COMM. RAILWAY | |

NO UTILITIES WILL BE AFFECTED
ON THIS SHEET EXCEPT MN/ DOT
STROM SEWER

INPLACE UTILITIES

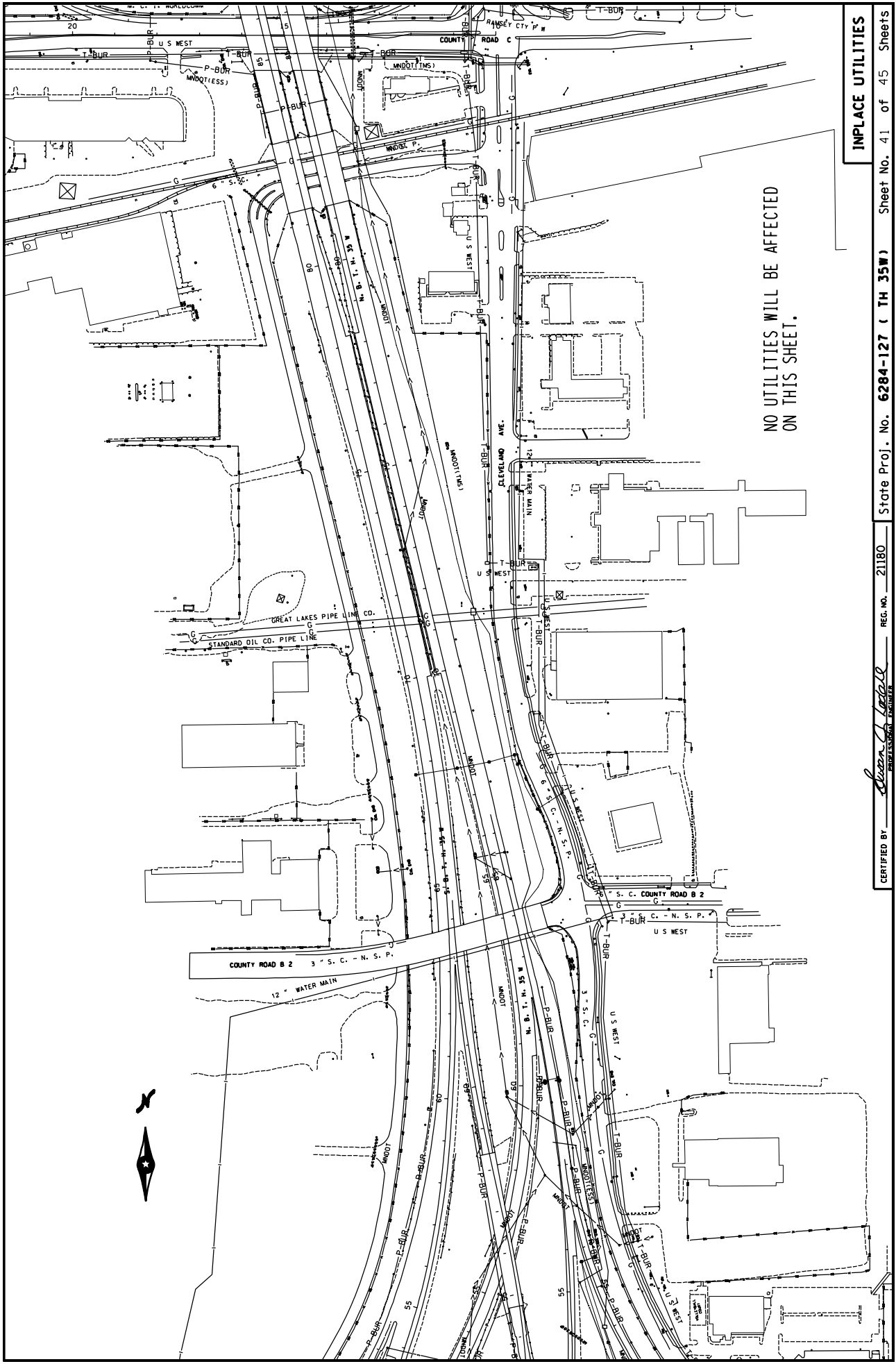

NO UTILITIES WILL BE AFFECTED
ON THIS SHEET.

INPLACE UTILITIES

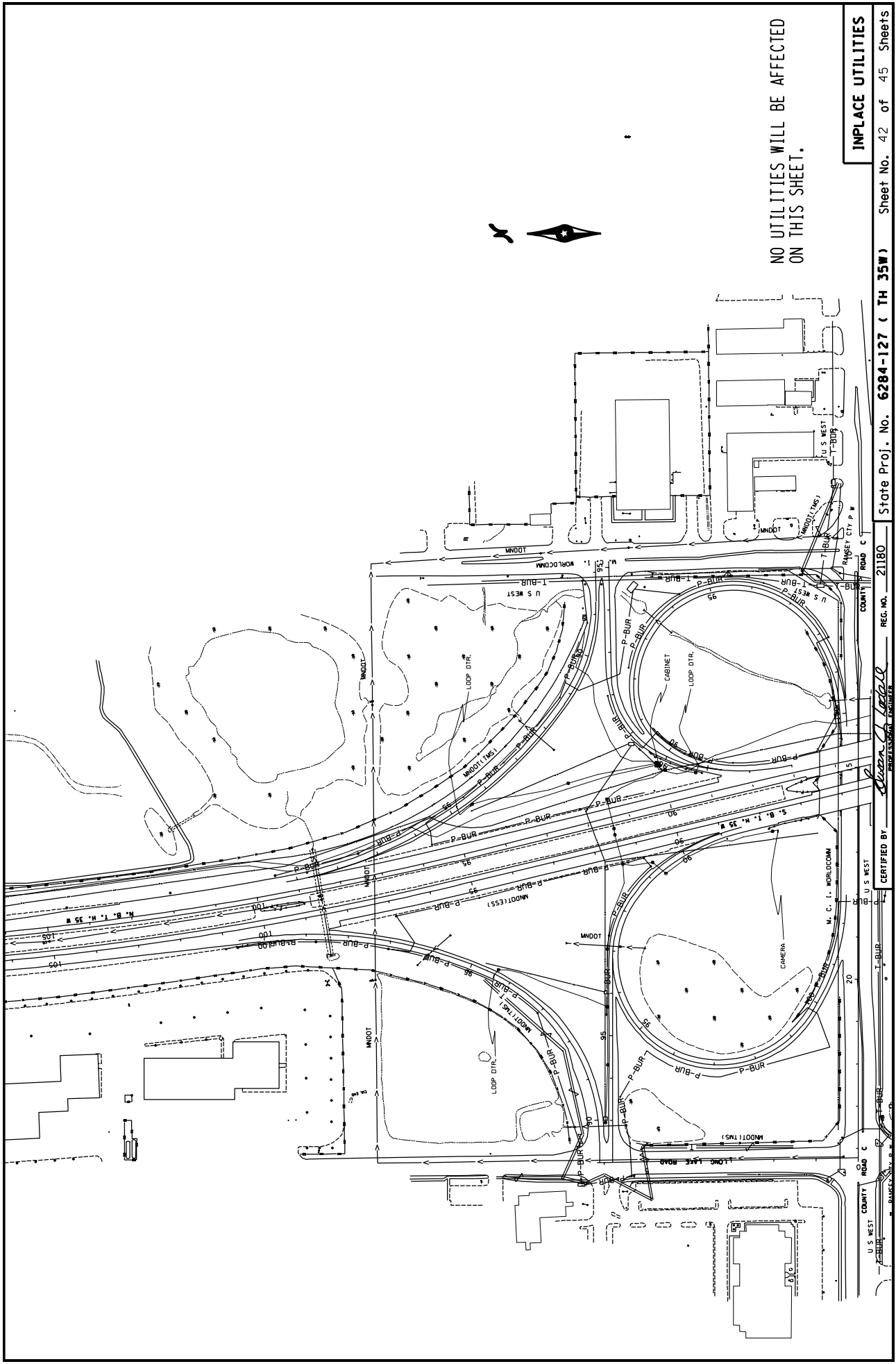

NO UTILITIES WILL BE AFFECTED
ON THIS SHEET.

INPLACE UTILITIES

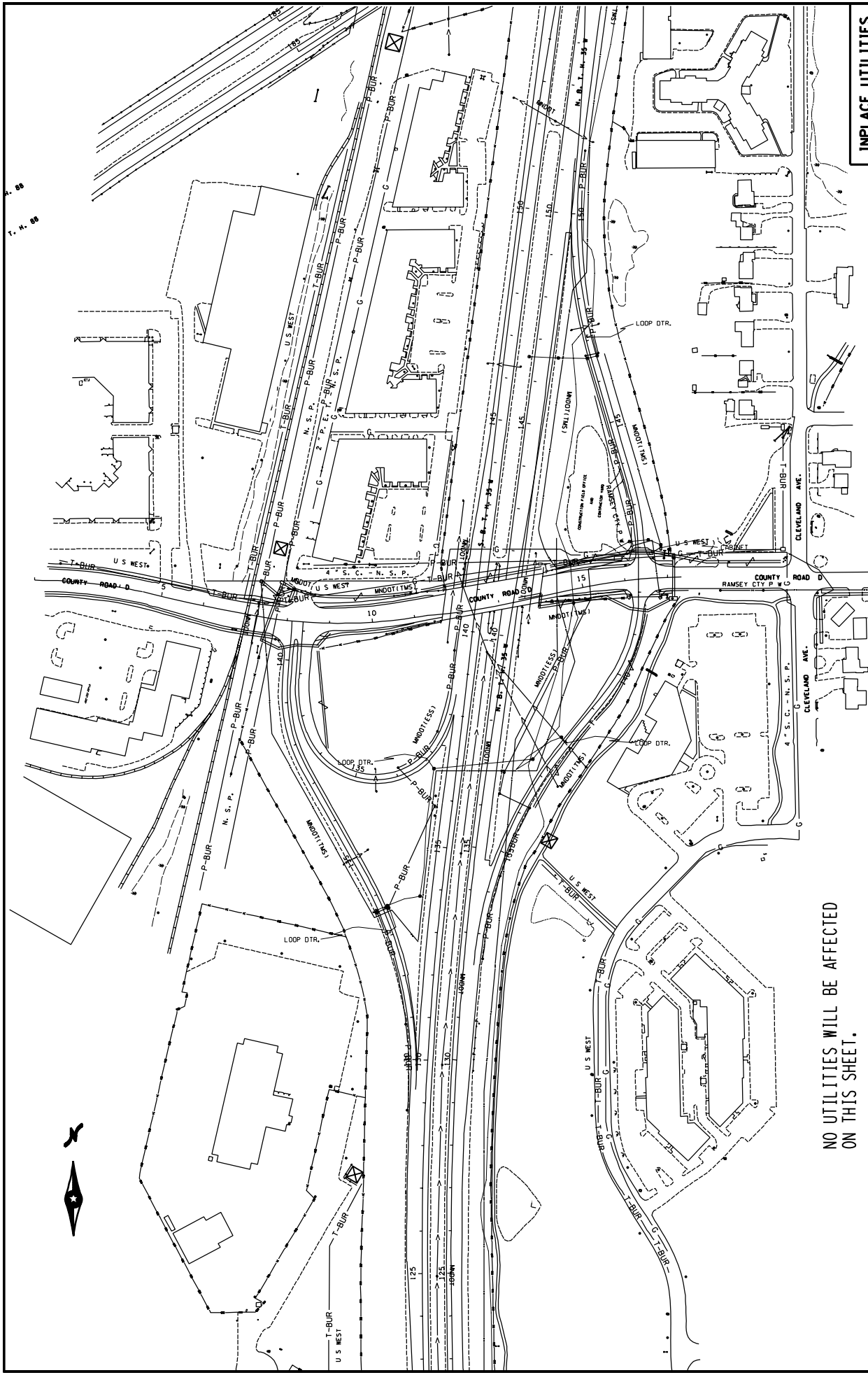

T. H. 88

NO UTILITIES WILL BE AFFECTED
ON THIS SHEET.

INPLACE UTILITIES

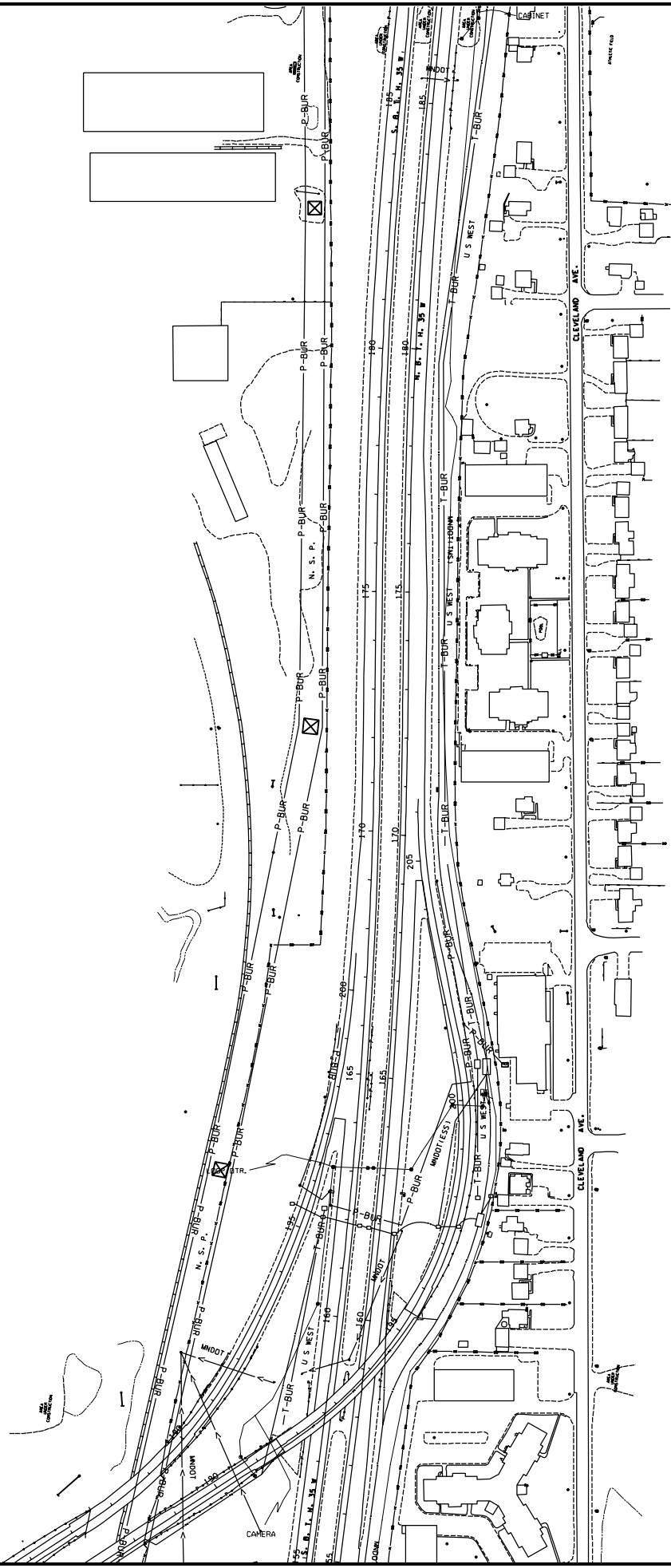

NO UTILITIES WILL BE AFFECTED
ON THIS SHEET.

INPLACE UTILITIES

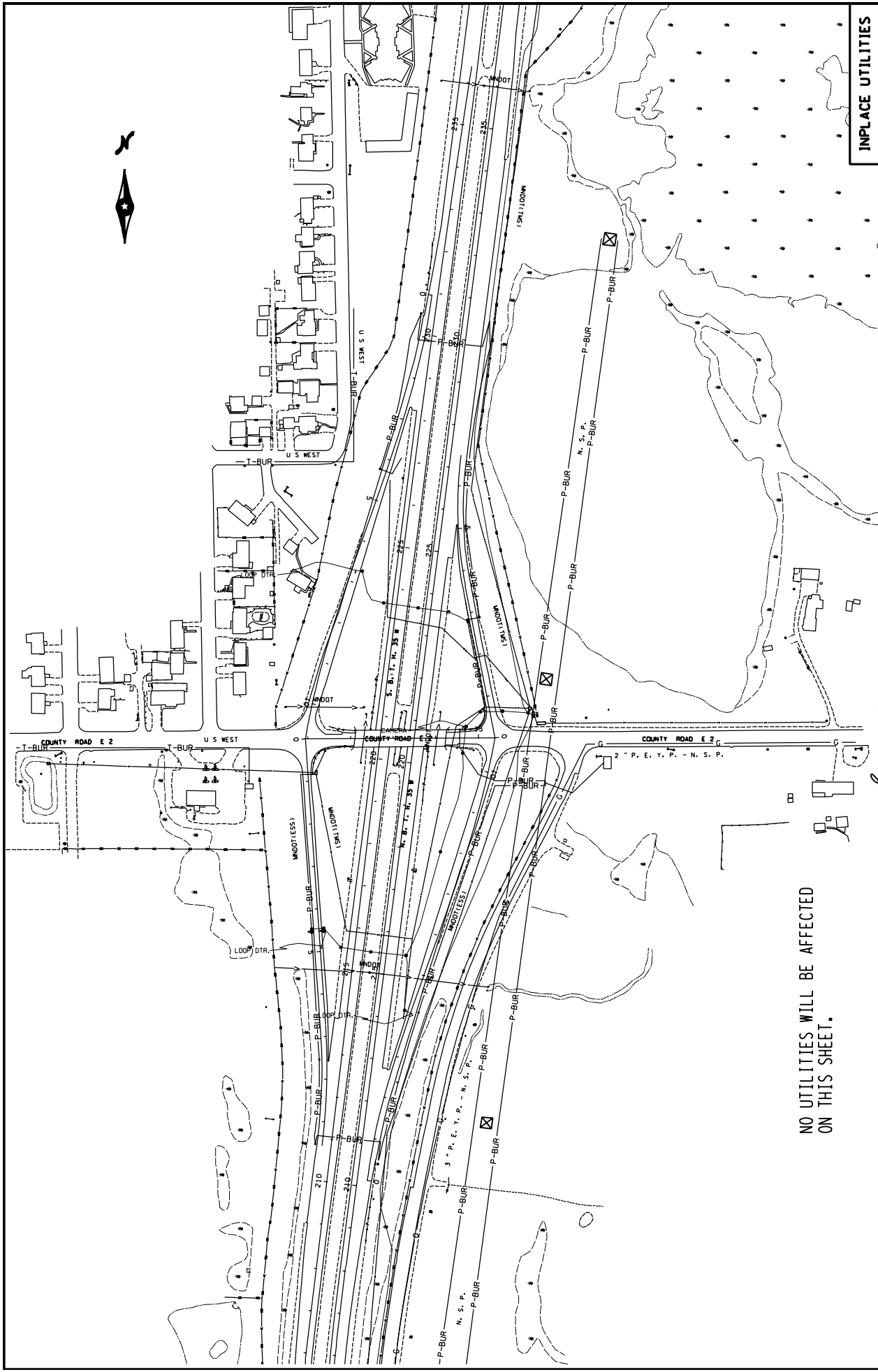

NO UTILITIES WILL BE AFFECTED
ON THIS SHEET.

INPLACE UTILITIES

THE FOLLOWING STANDARD PLATES APPROVED BY THE DEPT. OF TRANSPORTATION AND THE FEDERAL HIGHWAY ADMINISTRATION SHALL APPLY ON THIS PROJECT.

STANDARD PLATES	
PLATE NO.	DESCRIPTION
8114A	PULL BOX / HANDHOLE
8127B	LIGHT BASE DESIGN E
8140B	ROADWAY LIGHTING SERVICE CABINET

TABULATION OF LIGHTING QUANTITIES

ITEM	UNIT	S.P. 8282-96	
		ESTIMATED	QUANTITIES
REMOVE LIGHT STANDARD BASE	EACH		50
SALVAGE LIGHTING UNIT	EACH		52
SALVAGE SERVICE CABINET	EACH		1
LIGHTING UNIT TYPE PT	EACH		34
LIGHTING UNIT TYPE 6X-40	EACH		7
LIGHTING UNIT TYPE 6DX-40	EACH		9
LIGHTING UNIT TYPE 9-40	EACH		1
LIGHTING UNIT TYPE 12-40	EACH		6
LIGHTING UNIT TYPE VM-40	EACH		2
LIGHT BASE DESIGN E	EACH		23
LIGHT BASE DESIGN P	EACH		34
0.5" RIGID STEEL CONDUIT	LN FT		40
2" NON-METALLIC CONDUIT (DIRECTIONAL BORE)	LN FT		200
3" NON-METALLIC CONDUIT (DIRECTIONAL BORE)	LN FT		235
UNDERGROUND WIRE 1 CONDUCTOR, NO.4	LN FT		1600
UNDERGROUND WIRE 1 CONDUCTOR, NO.10	LN FT		600
ARMORED CABLE 3 CONDUCTOR, NO.4	LN FT		12190
SERVICE CABINET SECONDARY TYPE L2	EACH		1
HANDHOLE	EACH		2

I HEREBY CERTIFY THAT SHEETS 12 TO 23 HAVE BEEN PREPARED BY ME OR UNDER MY DIRECT SUPERVISION AND I AM A DULY LICENSED PROFESSIONAL ENGINEER UNDER THE LAWS OF THE STATE OF MINNESOTA.

SEAN DELMORE

DATE

LIC. NO. 40945



CERTIFIED BY Sean Delmore LIC. NO. 40945 State Proj. No. 8282-96 (T.H. 94) Sheet No. 12 of 28 Sheets

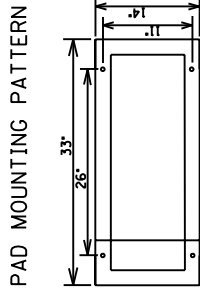
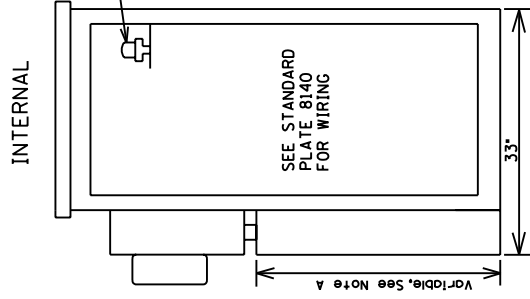
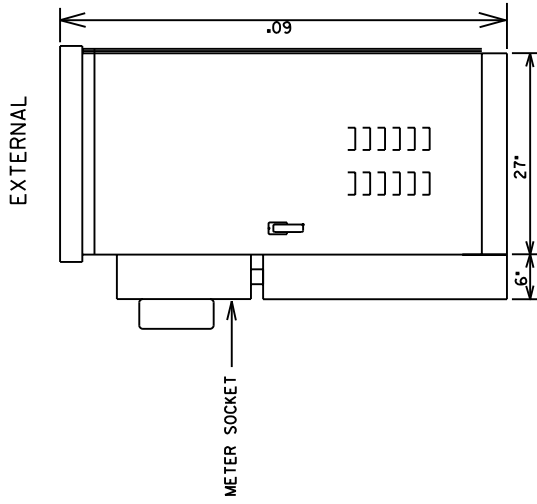

Note A: Height of compartment is approximately 33".
May vary depending upon size of meter socket.

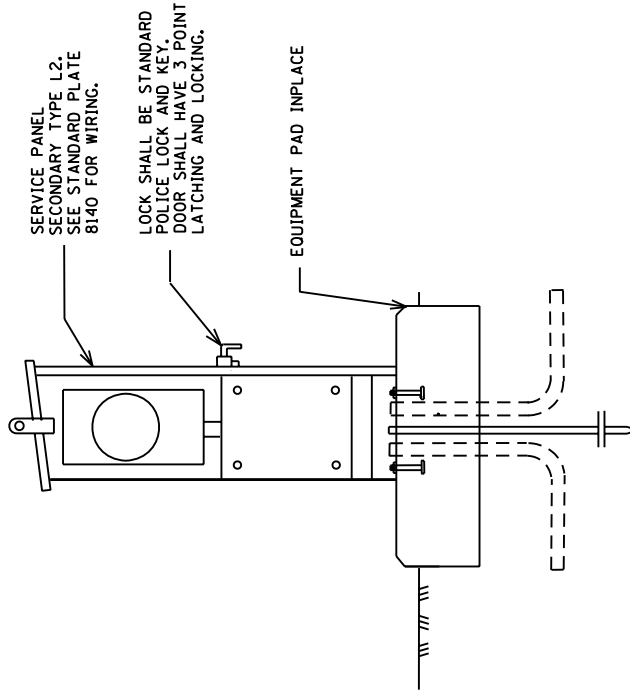

LIGHTING SERVICE CABINET
SERVICE CABINET SECONDARY TYPE L2

SIDE VIEWS

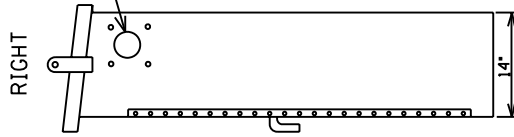
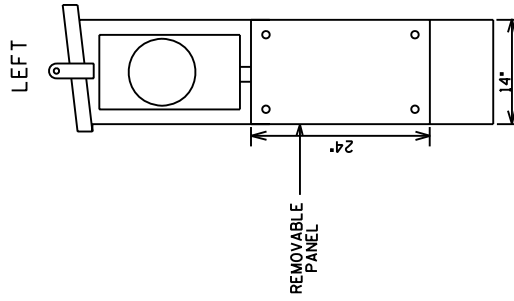

BACK VIEW

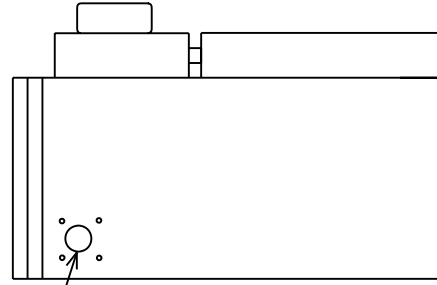

CERTIFIED BY *Sam Adams*
LICENSED PROFESSIONAL ENGINEER

LIC. NO. 40945

State Proj. No. 8282-96

(T.H. 94)

Sheet No. 13

of 28 Sheets

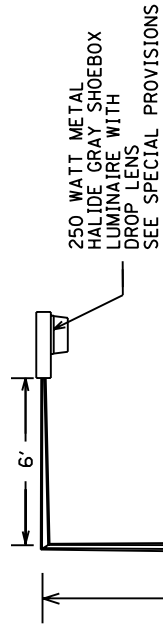

LIGHTING UNIT TYPE 6X-40

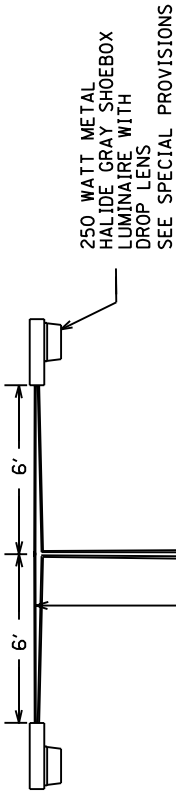

LIGHTING UNIT TYPE 6DX-40

LUMINAIRES SHALL BE AMERICAN ELECTRIC LUXMASTER SERIES 154 WITH DROP LENS OR APPROVED EQUAL. SHALL HAVE CONSTANT WATTAGE OR REGULATED BALLAST FOR 120 VOLT.

LUMINAIRE HOUSING SHALL BE AMERICAN ELECTRIC LUXMASTER SERIES 54 WITH DROP LENS OR APPROVED EQUAL.

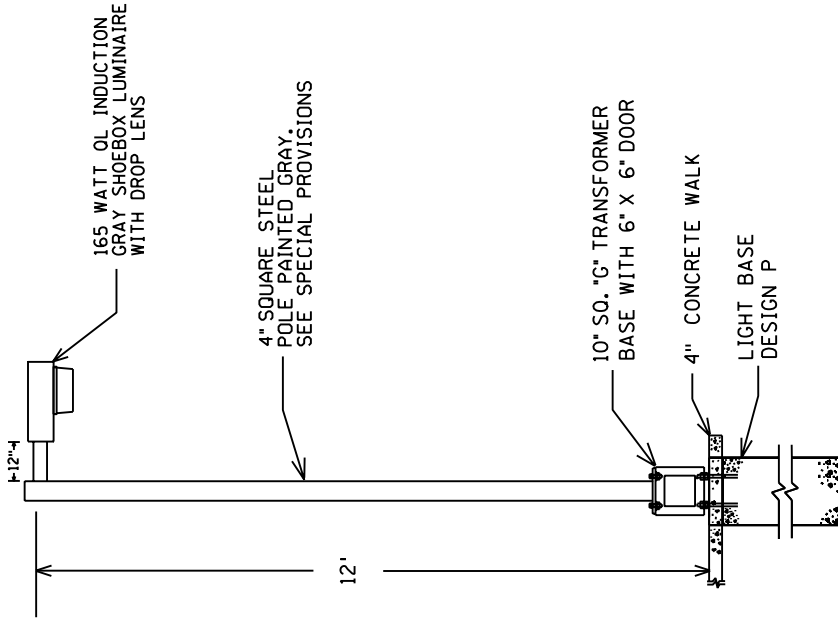

LIGHTING UNIT TYPE PT

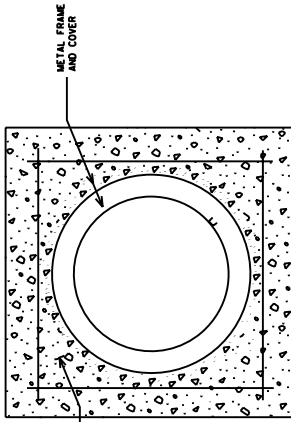

CONCRETE 12" x 12" x 4" DEEP. CONCRETE PAD. CONCRETE MIX 3432. PLACE NO. 13 REBARS AS SHOWN.

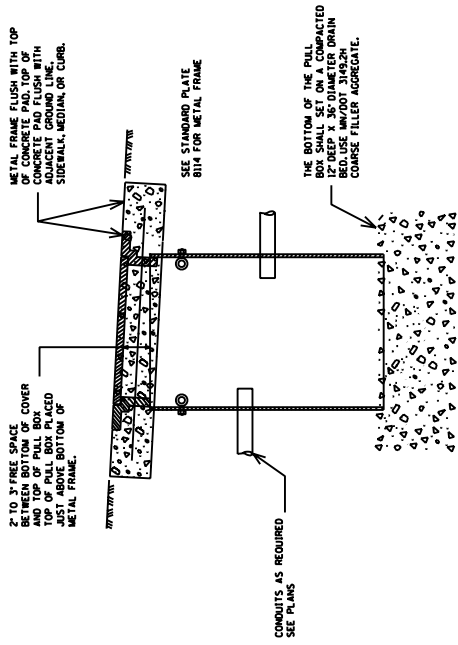

METAL FRAME FLUSH WITH TOP OF CONCRETE PAD. TOP OF CONCRETE PAD SHALL BE WITH ADJACENT GROUND LINE, SIDEWALK, MEDIAN, OR CURB.

SEE STANDARD PLATE 8114 FOR METAL FRAME

THE BOTTOM OF THE PULL BOX SHALL SET ON A COMPACTED 12" DEEP X 3/8" DIAMETER DRAIN BED. USE M/M/100/324924 COURSE FILLER AGGREGATE.

PULL BOX WITH CONCRETE SURROUND
SEE STANDARD PLATE 8114 FOR PULL BOX CONSTRUCTION DETAILS

Sam Adams
LICENSED PROFESSIONAL ENGINEER

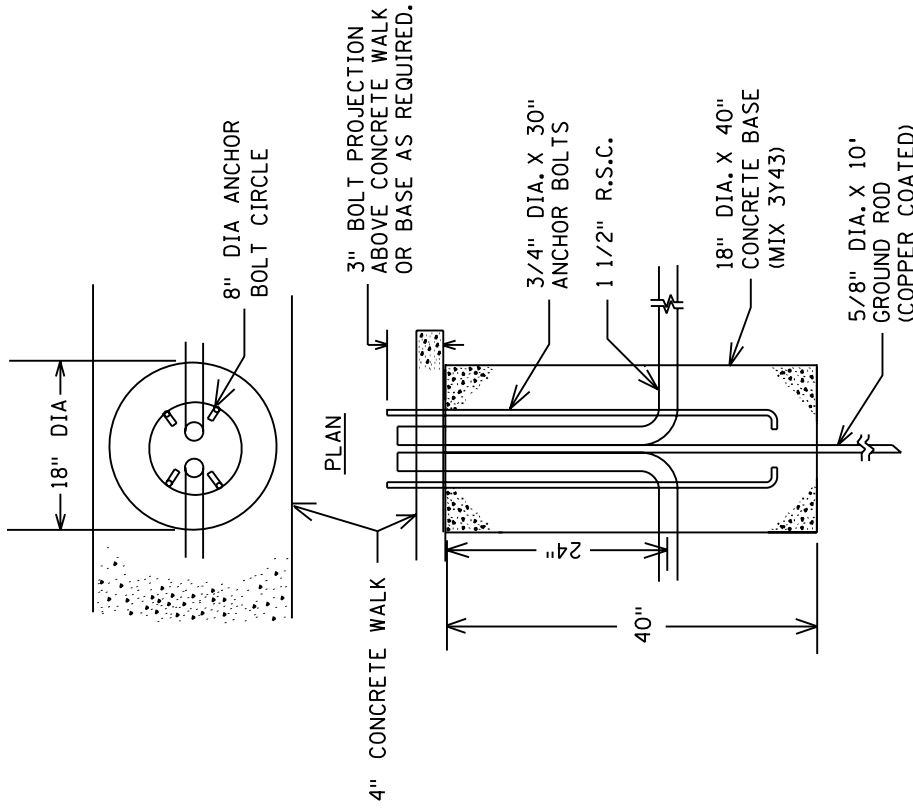

ELEV.

LIGHT BASE DESIGN P

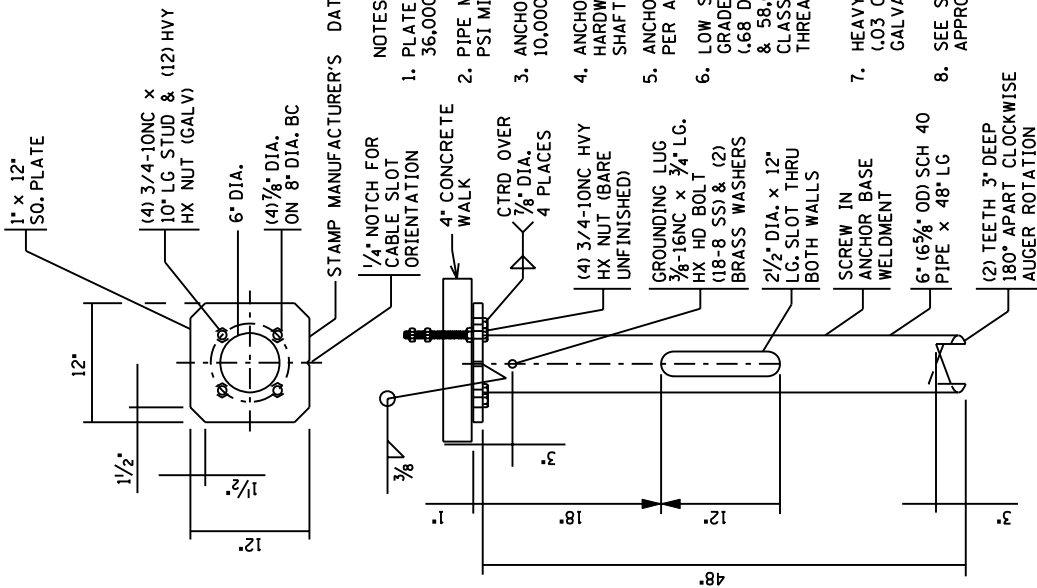

STAMP MANUFACTURER'S DATE

NOTES:

1. PLATE MATERIAL - LOW CARBON STEEL 36,000 PSI MIN YIELD PER ASTM A36
2. PIPE MATERIAL - 6" SCH 40 PIPE 35,000 PSI MIN. YIELD PER ASTM 53 GRB
3. ANCHOR BASE IS DESIGNED TO WITHSTAND 10,000 FT LBS OF INSTALLATION TORQUE
4. ANCHOR BASE SHOULD BE SHIPPED WITH HARDWARE BAGGED AND SECURED TO PIPE SHAFT
5. ANCHOR BASE TO BE HOT DIP GALVANIZED PER ASTM A123
6. LOW STRENGTH STUD PER ASTM F1554 GRADE 36, MATERIAL - ASTM A36 ROD (.68 DIA.) WITH 36,000 PSI MIN YIELD & 58,000-80,000 PSI TENSILE STRENGTH, CLASS 2A AMERICAN STD B1.1 ROLLED THREAD & GALVANIZED PER ASTM A153
7. HEAVY HEX NUTS PER ASTM A563 GR A (.03 OVER SIZED FOR GALVANIZED STUD) GALVANIZED NUTS PER ASTM A153
8. SEE SPECIAL PROVISIONS FOR APPROVED MANUFACTURERS.

OPTIONAL LIGHT BASE DESIGN STEEL (P)

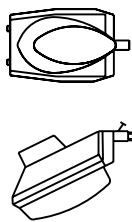

250 WATT METAL HALIDE LUMINAIRE

VERTICAL MOUNT LUMINAIRES

G.E. TURNPIKE REGULATED BALLAST FOR 120 VOLTS, CAT. NO. RPF540MOAIGLN3GRS
AMERICAN ELECTRIC INTERSTATE II, REGULATED BALLAST FOR 120 VOLTS, CAT. NO. 7760D132N000
LAMPS SHALL BE 250 WATT METAL HALIDE
LUMINAIRES SHALL HAVE A TYPE III SEMI-CUTOFF DISTRIBUTION

STAINLESS STEEL HIGH BASE
ALUMINIUM TRANSFORMER BASE
LIGHT BASE DESIGN E
STANDARD PLATE 8127

LIGHTING UNIT TYPE VM-40

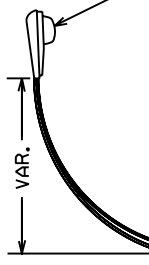

250 WATT METAL HALIDE LUMINAIRE WITH WIRE HOLDER

LUMINAIRES

COOPER LIGHTING WITH CONSTANT WATTAGE BALLAST FOR 120 VOLTS CAT NO. OVY25MCW2E
GENERAL ELECTRIC M-400R2, AUTO-REGULATOR BALLAST FOR 120 VOLTS CAT. NO. MSCL25M0A12GMC2
LUMEC - SCHREDER HELIOS HBM WITH CONSTANT WATTAGE BALLAST FOR 120 VOLTS CAT. NO. HBM250MHMS20TA120CWAGLS
LAMPS SHALL BE 250 WATT METAL HALIDE
LUMINAIRES SHALL HAVE A TYPE II MEDIUM SEMI-CUTOFF DISTRIBUTION PER 1983 ANSII/IES STANDARDS WITH SHALLOW GLASS REFRACTOR

STAINLESS STEEL HIGH BASE
ALUMINIUM TRANSFORMER BASE
LIGHT BASE DESIGN E
STANDARD PLATE 8127

LIGHTING UNIT TYPE 9-40 & 12-40

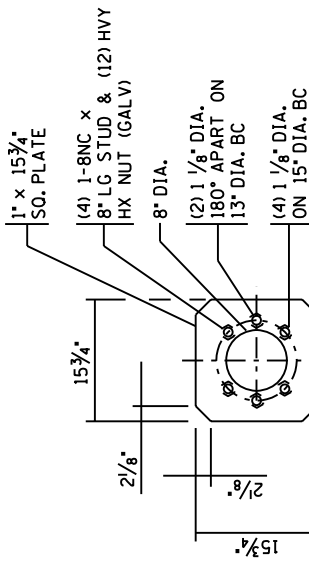

STAMP MANUFACTURER'S DATE

1/4" NOTCH FOR
CABLE SLOT
ORIENTATION

NOTES:

1. PLATE MATERIAL - LOW CARBON STEEL 36,000 PSI MIN YIELD PER ASTM A36
2. PIPE MATERIAL - 8" SCH 20 PIPE 35,000 PSI MIN. YIELD PER ASTM 53 GRB
3. ANCHOR BASE IS DESIGNED TO WITHSTAND 15,000 FT LBS OF INSTALLATION TORQUE
4. ANCHOR BASE SHOULD BE SHIPPED WITH HARDWARE BAGGED AND SECURED TO PIPE SHAFT
5. ANCHOR BASE TO BE HOT DIP GALVANIZED PER ASTM A123
6. HIGH STRENGTH STUD PER ASTM F1554 GRADE 105, MATERIAL - ASTM A29 GRADE 1541 (MODIFIED) STRESS RELIEVED ROD (.91 DIA.) WITH 105,000 PSI MIN YIELD & 125,000-150,000 PSI TENSILE STRENGTH, CLASS 2A AMERICAN STD B1.1 ROLLED THREAD & GALVANIZED PER ASTM A153
7. HEAVY HEX NUTS PER ASTM A194 GR 2H (.03 OVER SIZED FOR GALVANIZED STUD) GALVANIZED NUTS PER ASTM A153
8. SEE SPECIAL PROVISIONS FOR APPROVED MANUFACTURERS.

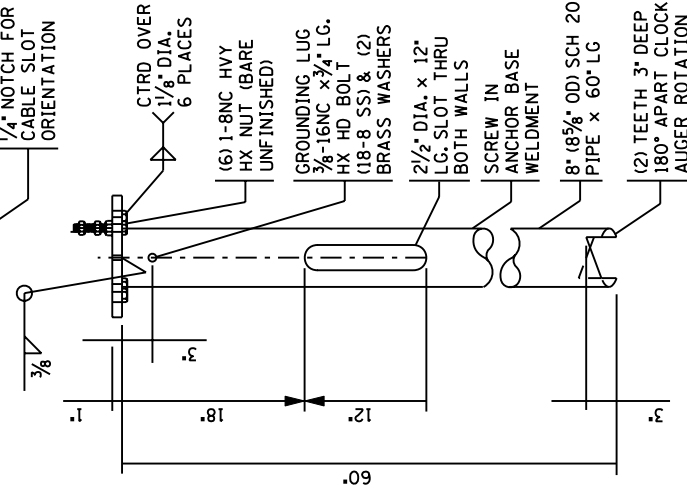

OPTIONAL LIGHT BASE DESIGN STEEL (E)

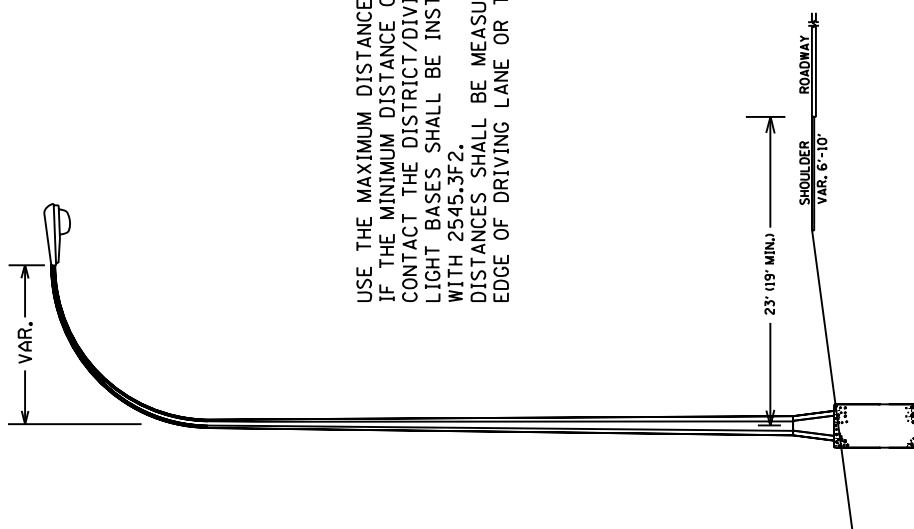

USE THE MAXIMUM DISTANCE WHENEVER POSSIBLE, IF THE MINIMUM DISTANCE CANNOT BE OBTAINED CONTACT THE DISTRICT/DIVISION TRAFFIC ENGINEER LIGHT BASES SHALL BE INSTALLED IN ACCORDANCE WITH 2545.3F2. DISTANCES SHALL BE MEASURED FROM THE EDGE OF DRIVING LANE OR TURN LANE.

LIGHTING UNIT TYPE 9-40 & 12-40

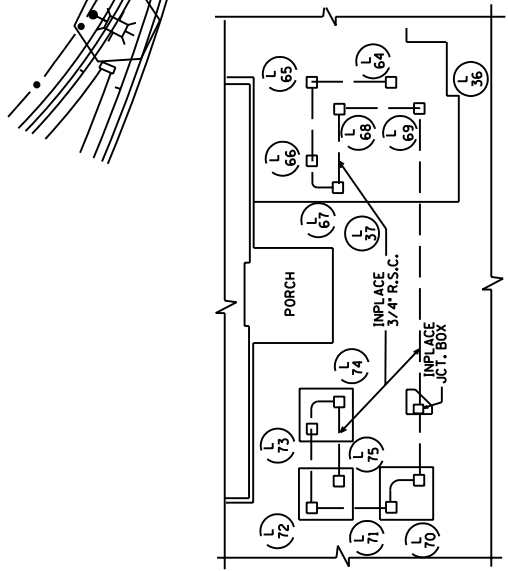

THESE LIGHTING UNITS ARE BEING REMOVED
SEE SHEET 4 OF LANDSCAPE REMOVAL

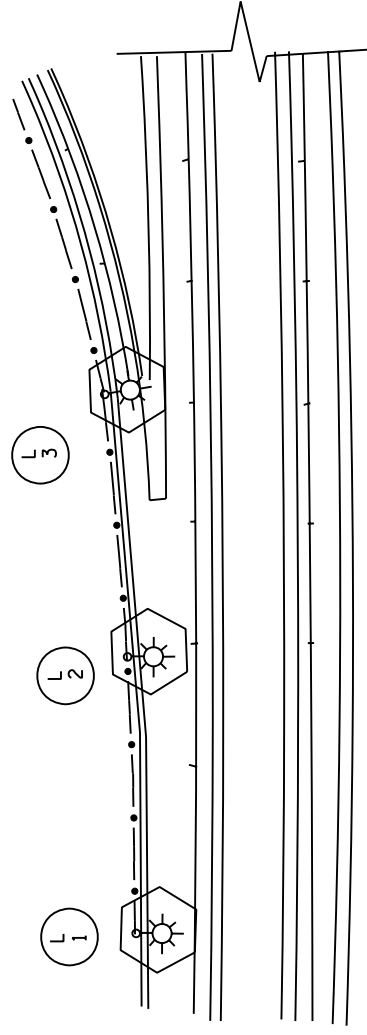
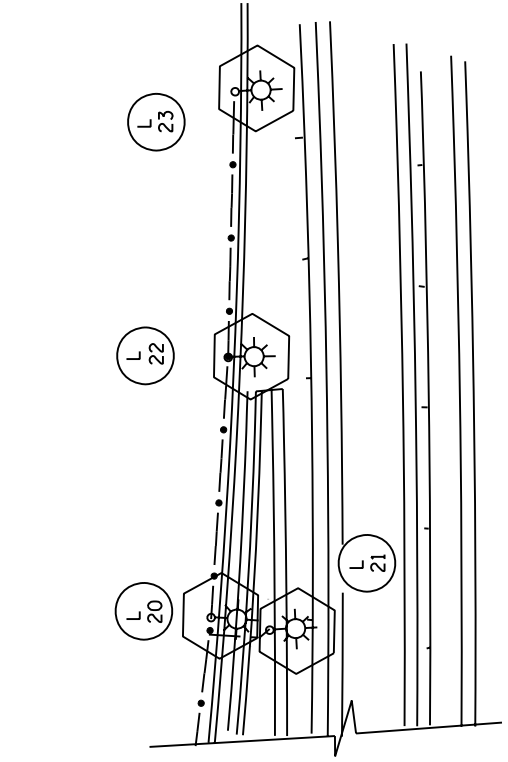



SALVAGE LIGHTING UNIT
REMOVE LIGHT STANDARD BASE

[Signature]
REGISTERED PROFESSIONAL ENGINEER

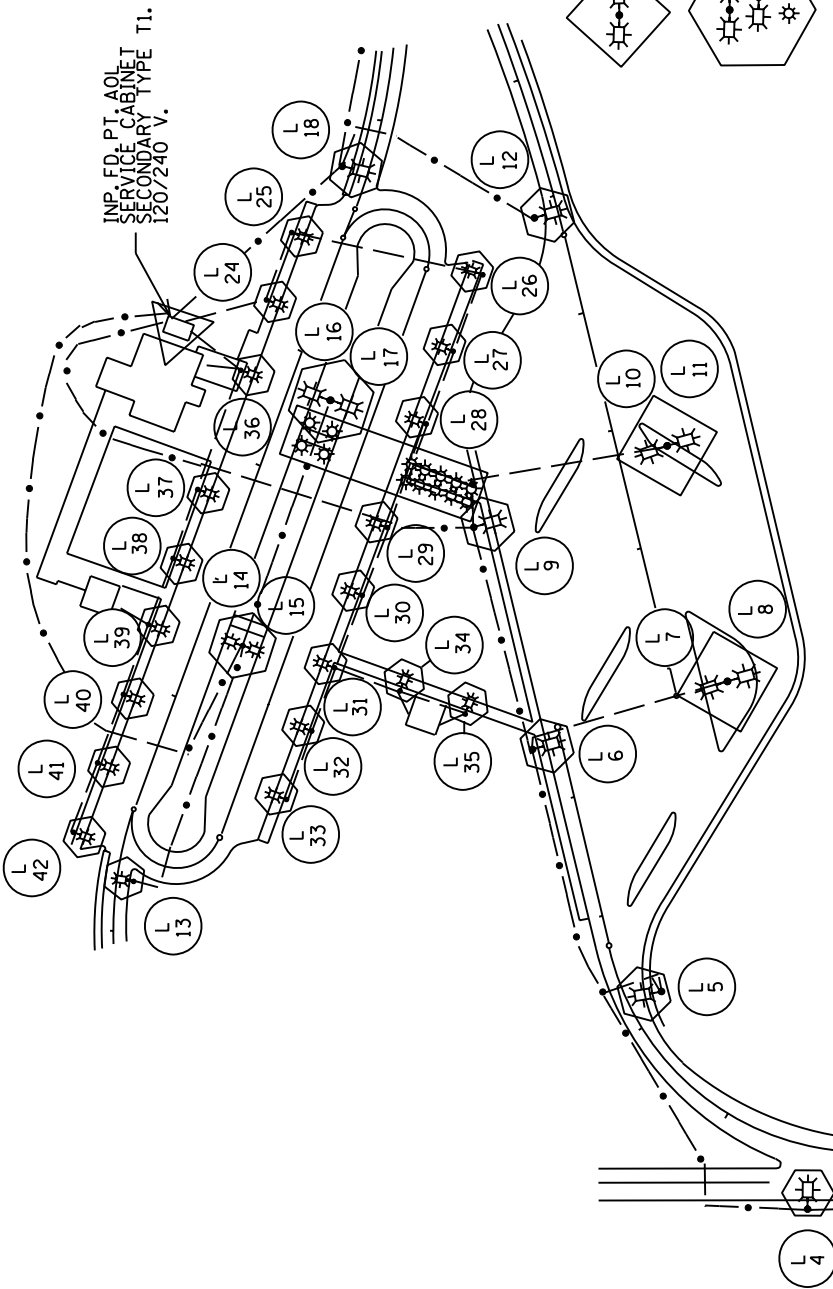
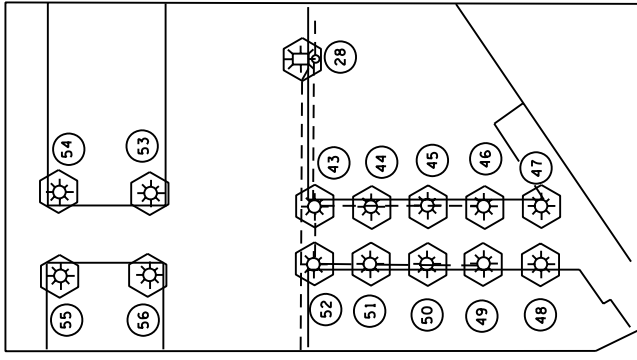
SALVAGE AND REMOVAL

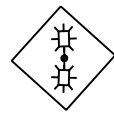
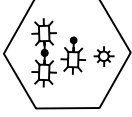

-  SALVAGE LIGHTING UNIT
-  SALVAGE LIGHTING UNIT REMOVE LIGHT STANDARD BASE
-  SALVAGE SERVICE CABINET

SALVAGE AND REMOVAL

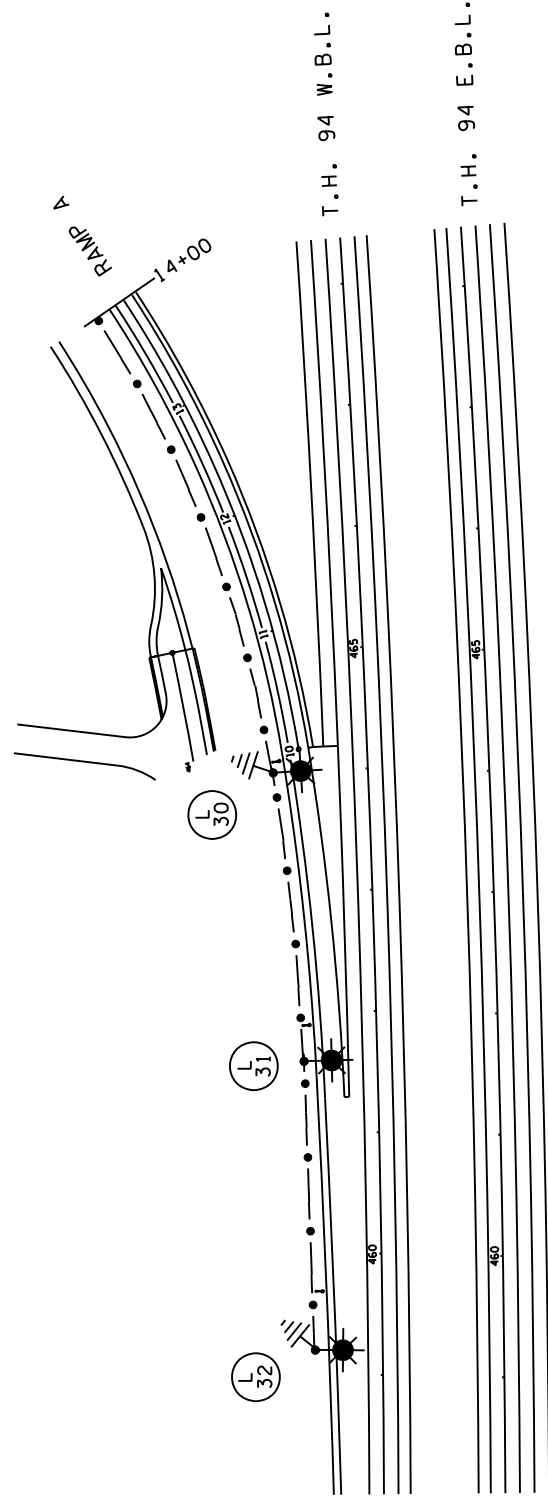
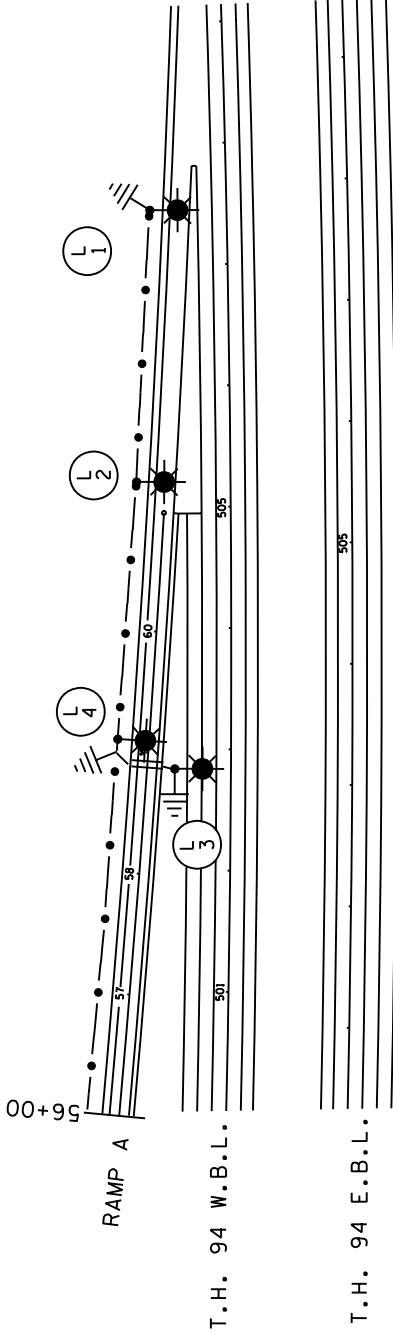

LIGHT PLAN

CERTIFIED BY *Steve Johnson*
 LICENSED PROFESSIONAL ENGINEER

LEGEND

- PAD MOUNTED SOURCE OF POWER 120/240V.
- * 165 WATT OL INDUCTION WALKWAY LIGHTING UNIT
- * 250 WATT METAL HALIDE LIGHTING UNIT (SHOEBOX)
- * 250 WATT METAL HALIDE LIGHTING UNIT (COBRAHEAD)
- * 250 WATT METAL HALIDE TWIN MAST ARM LIGHTING UNIT (SHOEBOX)
- INPLACE CONDUIT
- 3" RIGID NON-METALLIC CONDUIT SCHEDULE 80 EXCEPT AS NOTED OTHERWISE
- HANDHOLE
- ⊕ INPLACE SHELTER LIGHTING (50 WATT HPS)
- ⊖ PERMANENT GROUND ROD (25 OHMS OR LESS)
- DIRECT BURIED POWER CABLE, 3 CONDUCTOR NO. 4 AWG ARMORED CABLE SPEC NO 3815

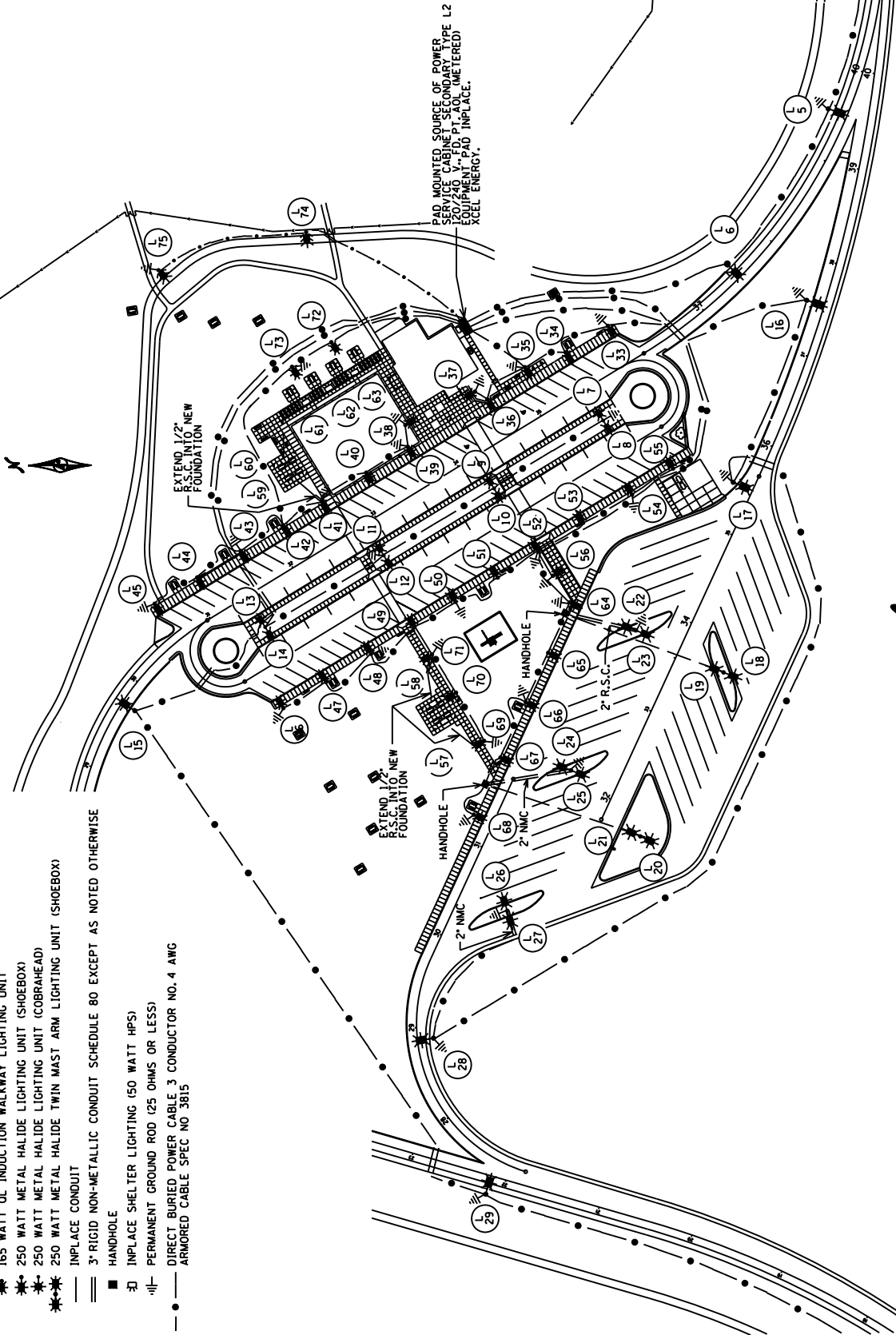

PAD MOUNTED SOURCE OF POWER L2
 120/240 V. 3 PH. 3 W. (METERED)
 EQUIPMENT PAD IN PLACE.
 XCEL ENERGY.

LIGHTING STANDARDS AND BASES			
NO.	STATION	L.T. RT.	LOCATION TYPE
(2)	1	507+45	-
(2)	2	505+15	-
(2)	3	502+85	-
(2)	4	502+85	-
(2)	5	39+50	-
(3)	6	37+50	-
(3)	7	35+60	-
(3)	8	34+20	-
(3)	9	34+20	-
(3)	10	32+80	-
(3)	11	31+40	-
(3)	12	29+75	-
(3)	13	37+50	-
(3)	14	35+50	-
(3)	15	33+68	-
(3)	16	31+80	-
(3)	17	33+68	-
(3)	18	32+10	-
(3)	19	30+51	-
(3)	20	28+85	-
(3)	21	22+15	-
(3)	22	464+00	-
(3)	23	461+70	-
(3)	24	459+40	-
(3)	25	AS SHOWN	-
(3)	26	AS SHOWN	-
(3)	27	AS SHOWN	-
(3)	28	AS SHOWN	-
(3)	29	AS SHOWN	-
(3)	30	AS SHOWN	-
(3)	31	AS SHOWN	-
(3)	32	AS SHOWN	-
(3)	33	AS SHOWN	-
(3)	34	AS SHOWN	-
(3)	35	AS SHOWN	-
(3)	36	AS SHOWN	-
(3)	37	AS SHOWN	-
(3)	38	AS SHOWN	-
(3)	39	AS SHOWN	-
(3)	40	AS SHOWN	-
(3)	41	AS SHOWN	-
(3)	42	AS SHOWN	-
(3)	43	AS SHOWN	-
(3)	44	AS SHOWN	-
(3)	45	AS SHOWN	-
(3)	46	AS SHOWN	-
(3)	47	AS SHOWN	-
(3)	48	AS SHOWN	-
(3)	49	AS SHOWN	-
(3)	50	AS SHOWN	-
(3)	51	AS SHOWN	-
(3)	52	AS SHOWN	-
(3)	53	AS SHOWN	-
(3)	54	AS SHOWN	-
(3)	55	AS SHOWN	-
(3)	56	AS SHOWN	-
(3)	57	AS SHOWN	-
(3)	58	AS SHOWN	-
(3)	59	AS SHOWN	-
(3)	60	AS SHOWN	-

LIGHTING STANDARDS AND BASES			
NO.	STATION	L.T. RT.	LOCATION TYPE
61	INPLACE		ARBOR
62	INPLACE		ARBOR
63	INPLACE		ARBOR
64	AS SHOWN		WALKWAY
65	AS SHOWN		PT
66			
67			
68			
69			
70			
71			
72			
73			
74			
75	AS SHOWN		

FD. PT. AOL
120/240 VOLT

16 CIRCUIT BREAKERS

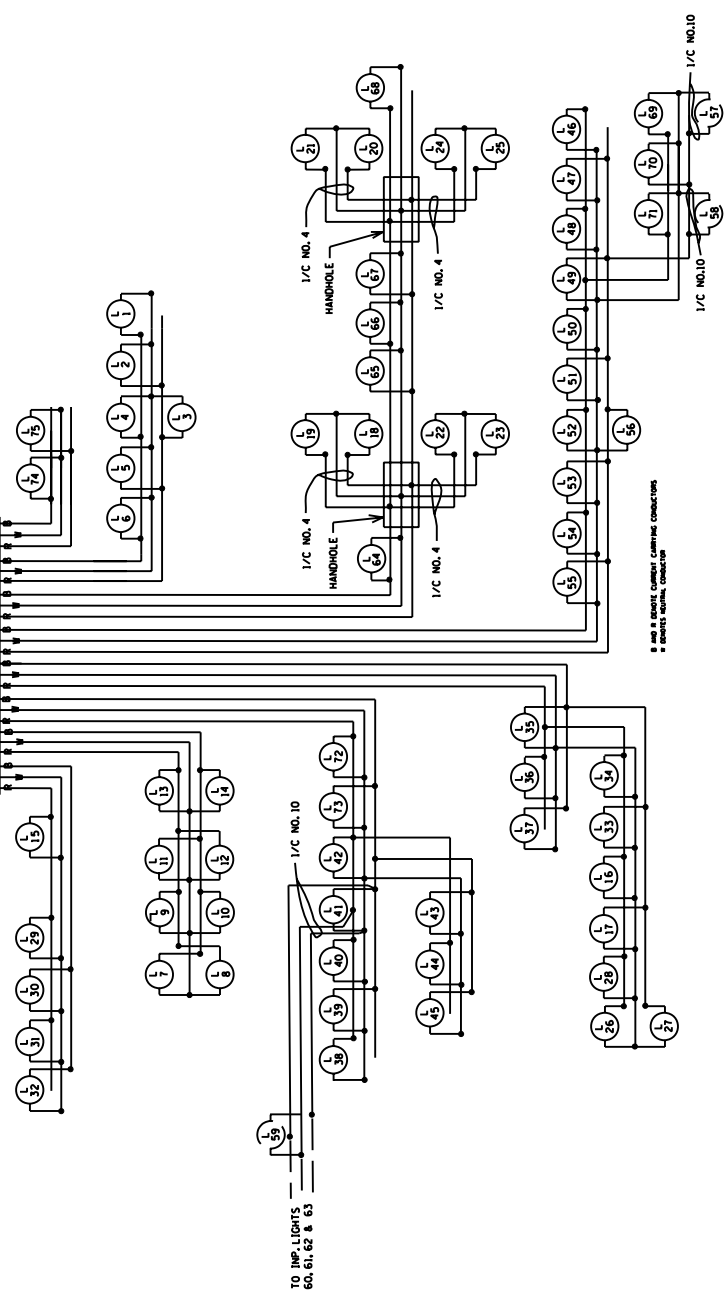

TO IMP LIGHTS
60, 61, 62 & 63

(1) FOUNDATION INPLACE
(2) SEE PLACEMENT DETAIL SHEET
(3) PLACE 9" BEHIND BIT, SHOULDER OR CURB
LOCATION AND DISTANCE OUT OF ALL OTHER LIGHTING
AND ENGINEER IN FIELD

CERTIFIED BY *Sam Alsharrah*
LICENSED PROFESSIONAL ENGINEER

Appendix A - Glossary of Lighting Terms

Cone of Vision - A fan-shaped field of view extending in front of a vehicle operator.

Ambient Light - Illumination at, near, or around a traffic facility but outside of the right-of-way.

Ballast - An auxiliary device used with high intensity discharge (HID) lamps to provide proper starting and operating characteristics. It limits the current through the lamp and may also regulate the voltage.

Candela - The unit of luminous intensity (the force generating the luminous flux). Formerly the term "candle" was used.

Complete Interchange Lighting - Applying lighting to the interchange to achieve illumination of all roadways in the interchange.

Davit Mast Arm - One-piece shaft which curves from vertical to horizontal.

Efficacy, Luminous Efficacy – The quotient of the total luminous flux delivered from a lamp to the total power input to the lamp, expressed in lumens per watt.

Glare - The brightness of a light source which causes eye annoyance, discomfort, or loss in visual performance and visibility.

Gore - On a freeway or expressway, the area where the mainline of the roadway and the ramp diverge or converge.

High Base - Transformer base which tapers from a base plate to a smaller shaft.

Illumination – The density of luminous flux incident on a surface; it is the quotient of the luminous flux by the area of the surface when the latter is uniformly illuminated, expressed in lumens per square meter.

Lamp - A source of light. The device within a luminaire which converts the electrical energy to light.

Light-Loss Factor - A depreciation factor which is applied to the calculated initial average lux to determine the value of depreciated average illumination at a predetermined time in the operating cycle, usually just prior to relamping, and which reflects the decrease in effective light output of a lamp and luminaire during its life.

Lumen – The unit of luminous flux (time rate of flow of light).

Luminance - The luminous intensity of any surface in a given direction per unit of projected area of the surface as viewed from that direction, expressed in candela per square meter.

Lux - The International System (SI) unit of illumination. One lux is defined as the illumination incident on a surface of one square meter, all points of which are one meter from a uniform source of one candela.

Partial Interchange Lighting - Illuminating only the parts of the interchange that are most critical to the night driver.

Pavement Reflection Factor (or Reflectance) - The ratio of the light reflected by a pavement surface to the light incident upon it.

Post Top Lighting Unit - A light pole with a short vertical shaft for mounting the luminaires

Progressive-Shear Base - A high base that is riveted or spot-welded to a base plate designed to shear progressively on impact.

Shoe Base - A low profile casting that connects the shaft to the pole base plate.

Slip Base - A pole base plate designed to slide off a lower plate on impact.

Specular Glare - Glare resulting from light being reflected from polished or glossy surfaces.

Transformer Base - A box-like structure between the foundation and pole base plate which can be used to accommodate the ballast and the underground wiring connections.

Truss Mast Arm - A horizontal bracket used to support the luminaires

Appendix B - List of References

A Policy on Geometric Design of Highways and Streets, American Association of State Highway and Transportation Officials, Washington, DC, 2001.

Roadway Lighting Design Guide, American Association of State Highway and Transportation Officials, Washington, DC, 2005.

Homburger, W.S., J.H. Kell, R.C. Loutzenheiser, W.R. Reilly, Fundamentals of Traffic Engineering, 14th Edition, Institute of Transportation Studies, University of California at Berkeley, Berkeley, CA, 1996.

Manual of Uniform Traffic Control Devices, Federal Highway Administration, Washington, DC, 2000.

Minnesota Manual of Uniform Traffic Control Devices, Minnesota Department of Transportation, December 2001.

Minnesota Traffic Engineering Manual, Minnesota Department of Transportation, Amended 2000.

Roadway Lighting Handbook, Federal Highway Administration, Washington, DC, 1978.

Traffic Control Devices Handbook, Institute of Transportation Engineers, Washington, DC, 2001.

Appendix C - Safety Benefits of Roadway Lighting Report

Summary Report

HSIS
HIGHWAY SAFETY INFORMATION SYSTEM

The Highway Safety Information System (HSIS) is a multi-State safety data base that contains crash, roadway inventory, and traffic volume data for a select group of States. The participating States—Illinois, Maine, Michigan, Minnesota, and Utah—were selected based on the quality of their data, the range of data available, and their ability to merge data from the various files. The HSIS is used by FHWA staff, contractors, university researchers, and others to study current highway safety issues, direct research efforts, and evaluate the effectiveness of crash countermeasures.



U.S. Department of Transportation
Federal Highway Administration

Research and Development
Turner-Fairbank Highway
Research Center
6300 Georgetown Pike
McLean, Virginia 22101-2296

COMPARISON OF THE SAFETY OF LIGHTING OPTIONS ON URBAN FREEWAYS



Nationwide accident statistics show that more than 50 percent of fatal accidents occur during the hours of darkness. Because only 25 percent of travel occurs during the same period, the fatality rate is about three times higher at night than during the day. The installation of overhead lighting is a potential countermeasure to this nighttime accident problem. However, this is expensive, and much of the research to date offers inconclusive results about its effect on highway safety.

Many previous studies have evaluated the relationship of urban freeway lighting and highway safety. However, the majority of these studies were conducted in the 1960's and early 1970's, and the results from these studies may be outdated. On our Nation's highways, there have been many changes in traffic flow, vehicle fleet, and road-user demography in the past 20 to 30 years. Clearly, the volume of traffic on urban freeways is significantly higher today, and congestion is a greater problem.

This study compared the safety of continuously lighted urban freeways and urban freeways with interchange lighting only. A freeway section with continuous lighting has overhead lighting at the interchanges and between the interchanges, as opposed to overhead lighting at the interchanges only.

State Data Bases Used

Minnesota was the only HSIS State with a sufficient number of urban freeway sections with roadway lighting that had complete accident, roadway, and lighting information to permit a safety analysis of roadway lighting on urban freeways. In addition, at the time of the study, Minnesota was the only HSIS State with a videodisc photolog system. The Minnesota videodisc photolog system is a key tool in the HSIS laboratory, which allows users to have automatic computer access to all video images of the State-maintained roadway network. This system is used to collect supplementary data for studies and to verify existing data.

Currently, the HSIS laboratory has videodisc photolog systems for Minnesota and Michigan.

Analysis Methods

A cross-section approach was used in this research study to assess the safety effects of urban freeway lighting. The cross-section approach compares the safety of sites that are different. Two groups of sites were compared in this study: urban freeway sections with continuous lighting and urban freeway sections with interchange lighting only. The urban freeways evaluated in this study are located in the Minneapolis-St. Paul metropolitan area.

A review of the Minnesota HSIS data files revealed that most of the desired accident and roadway variables needed to conduct this study were present. However, the files did not have the lighting information or 24-h traffic distributions needed to develop day versus night accident rates. The Minnesota Department of Transportation (MnDOT) was able to provide needed supplementary information to support HSIS data. MnDOT provided lighting information (identification of urban freeway sections with roadway lighting, type of lighting, etc.) and automatic traffic recorder reports that provided summaries of 24-h traffic distributions. Sunrise and sunset information was acquired from the United States Naval Observatory to classify accident and traffic volume data by day and night.

A total of 87.9 km of urban freeway segments with continuous lighting and 57.1 km of urban freeway segments with interchange lighting only was used in the study. There is one major roadway difference between the urban freeway sections with continuous lighting and those with interchange lighting only. This difference pertains to the number of interchanges per mile. The average spacing between interchanges is 1.3 km on the continuously lighted sections and 1.9 km on the sections with interchange lighting only. All of the interchanges are of the diamond type, except three that are cloverleafs.

Results

Day and night accident rates were calculated for the study sections. Accident data from 1985 through 1990 were used. Table 1 shows the total day accident rates, total night accident rates, and the total night/day accident-rate ratios. The total day accident rate is 3 times higher for the continuously lighted sections than the total day accident rate for the interchange lighting only sections. This contrast in the total day accident rate signifies differences exist between the subject sections. Comparisons between the subject sections can not be made without accounting for these differences. Night/day accident-rate ratios were calculated to adjust for roadway, traffic, driver, and/or other differences between the freeway sections with continuous lighting and those with interchange lighting only. The night/day accident rate ratio is computed by dividing the night accident rate by the day accident

rate. This ratio gives an indication of the relative magnitude of the night accident problem to the day accident problem.

The total night/day accident-rate ratio for the sections with interchange lighting only is 12 percent higher than the total night/day accident-rate ratio for sections with continuous lighting (a larger night/day accident-rate ratio indicates a relatively more hazardous night condition).

Figure 1 shows serious injury, injury, and property damage only (PDO) night/day accident-rate ratios. The only meaningful difference between the ratios is that the PDO night/day accident-rate ratio is 19 percent higher for the freeway sections with interchange lighting only than the PDO night/day accident-rate ratio for the continuously lighted sections.

Figure 2 shows the accident-rate ratios for interchange and non-interchange areas. For interchange areas, the night/day accident-rate ratios are statistically equal for continuously lighted sections and sections with interchange lighting only. One would expect these ratios to be similar since overhead lighting exists at the interchanges located on the sections with continuous lighting and the sections with interchange lighting only.

The night/day accident-rate ratio for non-interchange areas is 18 percent higher for sections with interchange lighting only than it is for continuously lighted sections. Statistically, the night/day accident-rate ratios for non-interchange areas are different. The primary focus of the study was to compare the non-interchange areas of the continuously lighted sections and interchange lighting only sections. The non-interchange areas of the continuously lighted sections are **lighted** and the non-interchange areas of the interchange lighting only sections are **unlighted**. A detailed analysis of the non-interchange areas was conducted.

Crash costs for lighted and unlighted sections for non-interchange areas were calculated. The costs were calculated for each accident severity by multiplying the accident frequency by the corresponding

Table 1. Accident rates.

	Continuous Lighting	Interchange Lighting	Difference
Total Day Accident Rate	1.50	0.48	
Total Night Accident Rate	1.95	0.70	
Total Night/Day Accident-Rate Ratio	1.30	1.46	+12%*

* Indicates that the ratios are statistically different.

Accident rate is per 1 million vehicle-miles traveled.

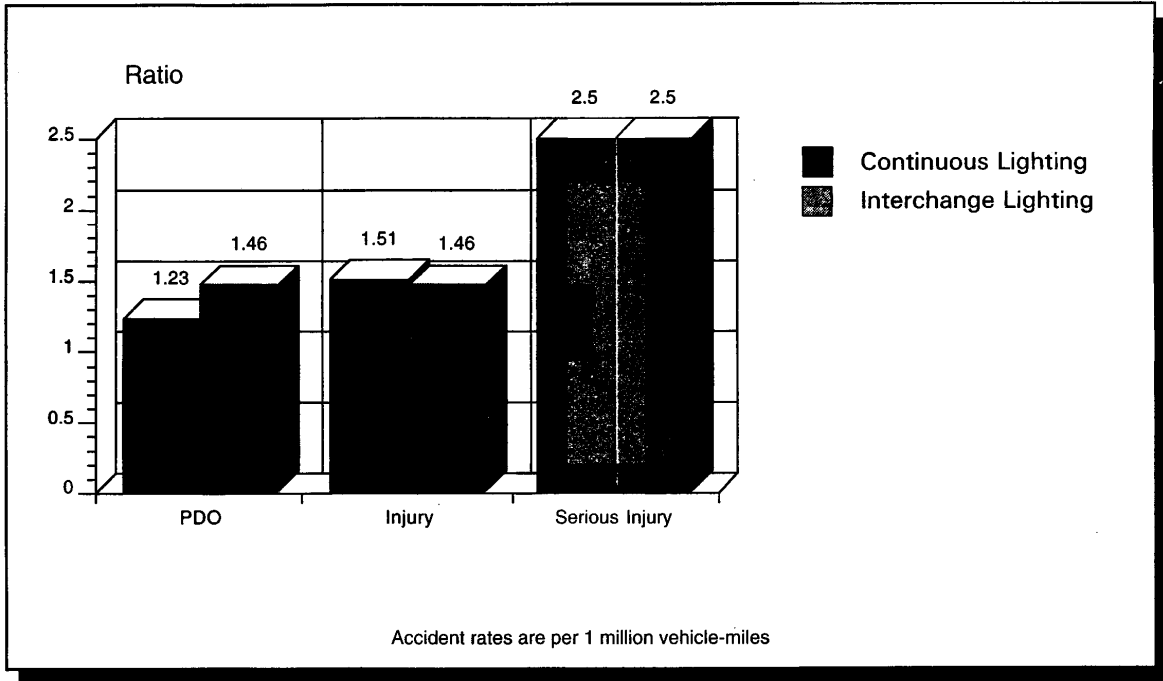

Figure 1. Night/day rate ratios

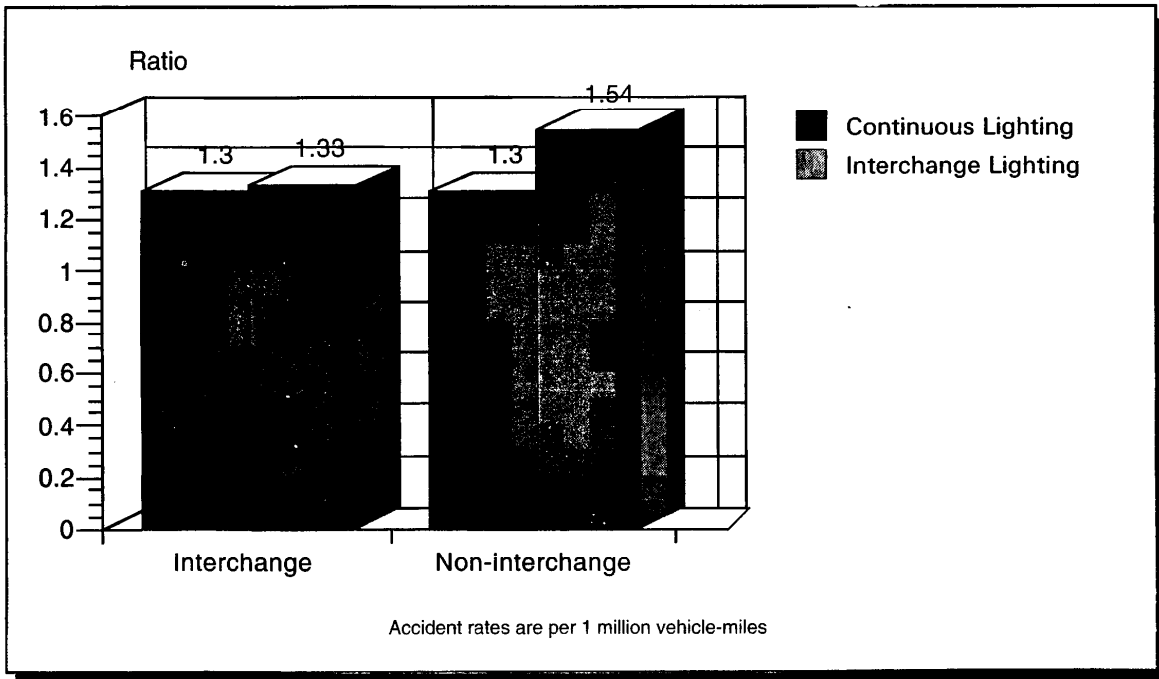

Figure 2. Total night/day rate ratios

cost per crash. The costs per crash used in 1988 dollars were: \$2,722,548 (K-fatal), \$228,568 (A-incapacitating), \$48,333 (B-evident), \$25,228 (C-possible), and \$4,489 (O-property damage).¹¹ For the lighted sections between interchange areas, the total crash costs for night and day were \$37,617,605 and \$46,270,320, respectively. For the unlighted sections between interchange areas, the total crash costs for night and day were \$17,727,099 and \$17,228,489, respectively.

Night/day crash-cost ratios were computed using the crash costs. The night/day crash-cost ratios for freeway sections between interchange areas with lighting and without lighting were $\$37,617,605 / \$46,270,320 = 0.81$ and $\$17,727,099 / \$17,228,489 = 1.03$, respectively. The night/day crash-cost ratio for freeway sections between interchange areas without overhead lighting is 27 percent higher than the night/day crash-cost ratio for freeway sections between interchange areas with overhead lighting.

A benefit/cost analysis was conducted for the freeway sections between the interchange areas with lighting. The hardware, installation, and electric power costs for an urban freeway lighting system were obtained from a New York Department of Transportation (NYDOT) official. The use of lighting system costs from New York was not deemed to be ideal. However, these costs could not be obtained from Minnesota DOT. The costs of overhead lighting systems can vary across different regions of the country and, therefore, the benefit/cost results should not be considered definitive.

Based on the NYDOT cost information, it's estimated that the total costs (hardware, installation, and power) from 1985 through 1990 for the 35 km of continuously lighted freeways between the interchange areas were \$2.7 million. The hardware and installation costs were established on a 20-year amortization period. These calculations are based on the assumption that the entire roadway lighting system was installed in 1984. The overhead lighting system was actually

installed between 1960 and 1984 at the study locations.

For the benefit/cost analysis, the expected night crash costs (if roadway lighting did not exist at these locations) had to be calculated for the 35 km of continuously lighted freeways between the interchange areas. This was found by using the night/day crash-cost ratio for the unlighted sections between the interchange areas. One would expect that if roadway lighting was not installed on the 35 km of continuously lighted freeways between interchange areas that the night/day crash-cost ratio would equal 1.03 (night/day crash-cost ratio for the unlighted sections) and not 0.81. The expected night crash costs were equal to \$47,658,429 ($\$46,270,320 \times 1.03$).

The actual night crash costs were \$37,617,605; this was \$10,040,824 less than the expected night costs. Therefore, the estimated economic benefit of roadway lighting is \$7,340,824 ($\$10,040,824 - \$2,700,000$ [estimated hardware, installation, and power costs]) for the years 1985 through 1990. The benefit/cost ratio equals 3.7 ($\$10,040,824 / \$2,700,000$).

Study Implications

Accurate estimates of the safety benefits of roadway lighting for urban freeways are needed. These estimates are required to better understand the potential impact roadway lighting can have on the nighttime accident problem for urban freeways. The majority of the previous research is 20 to 30 years old and it's inconclusive. This study provided new accurate information and found a positive relationship between roadway lighting and urban freeway safety.

Jurisdictions considering the installation of a roadway lighting system for an urban freeway facility need to assess its potential economic impact. Benefit/cost analyses should be conducted for the different types of freeway lighting systems that are being considered. The benefit/cost ratio of overhead lighting for the study's 35 km of urban freeway sections between

interchange areas is 3.7. This ratio is primarily a function of the reduction of property damage only (PDO) accidents.

Additional research is needed to develop an even stronger knowledge base on the safety effects of roadway lighting for urban freeways. A before-and-after study would be desirable with data from several States that have urban freeway lighting systems in service with a wide range of maintained illumination levels.

The warranting conditions for continuous freeway lighting, complete interchange lighting, and partial interchange lighting can be found in publication *The American Association of State Highway and Transportation Officials (AASHTO's) Informational Guide for Roadway Lighting*.

For More Information

This research was conducted by Michael S. Griffith, a mathematical statistician with FHWA in the Office of Safety and Traffic Operations R&D. The final report was published in the Autumn 1994 issue of FHWA's *Public Roads*. To obtain more information about the study or HSIS, contact Jeffrey F. Paniati, HSIS Program Manager, at (703) 285-2568.

Reference

1. *The Costs of Highway Crashes*, Federal Highway Administration, October 1991, FHWA-RD-91-055.

Appendix D - Standard Plates and Details

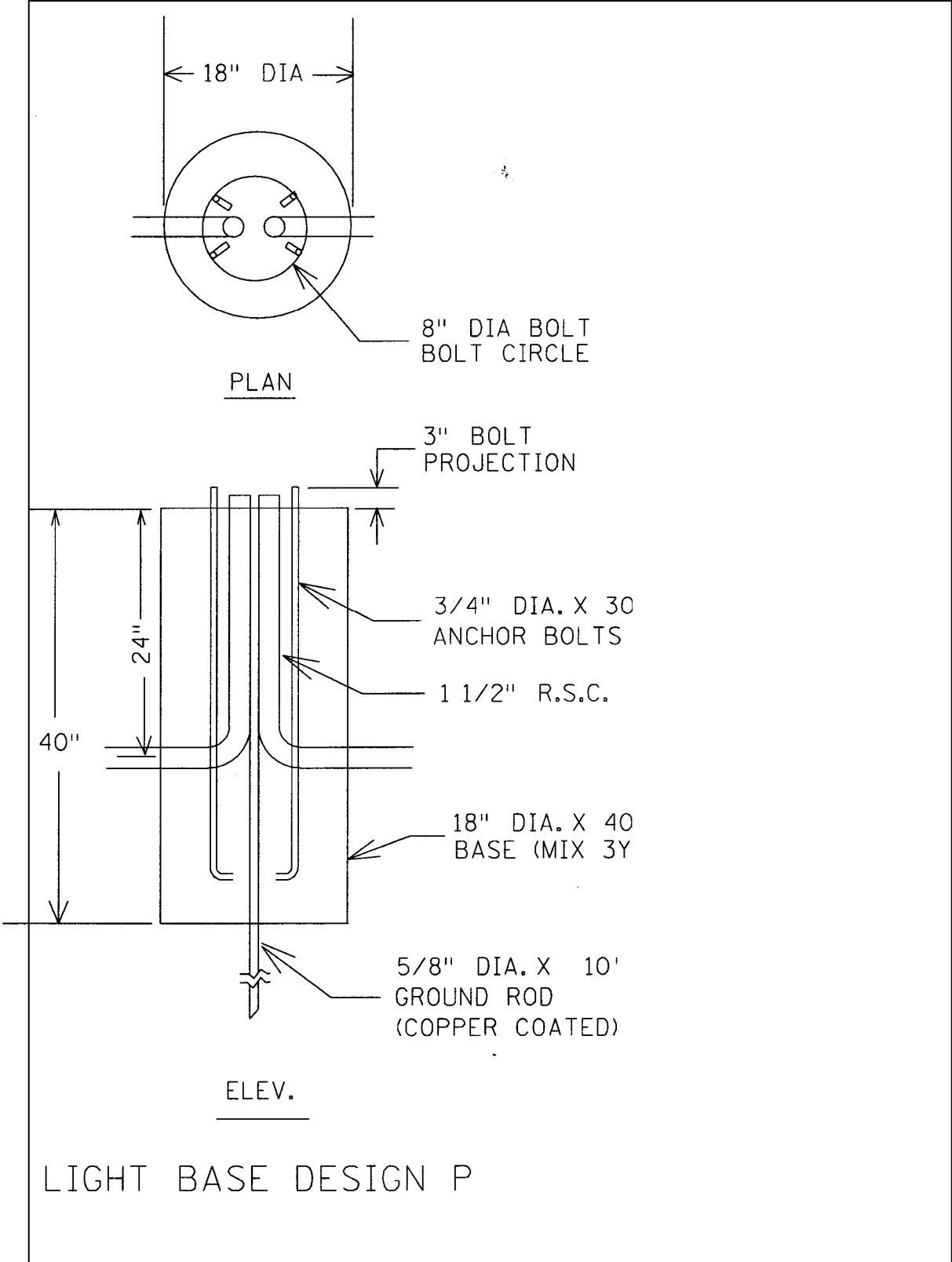

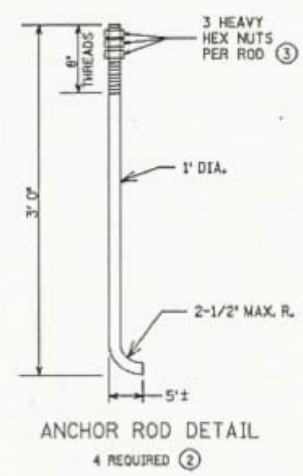
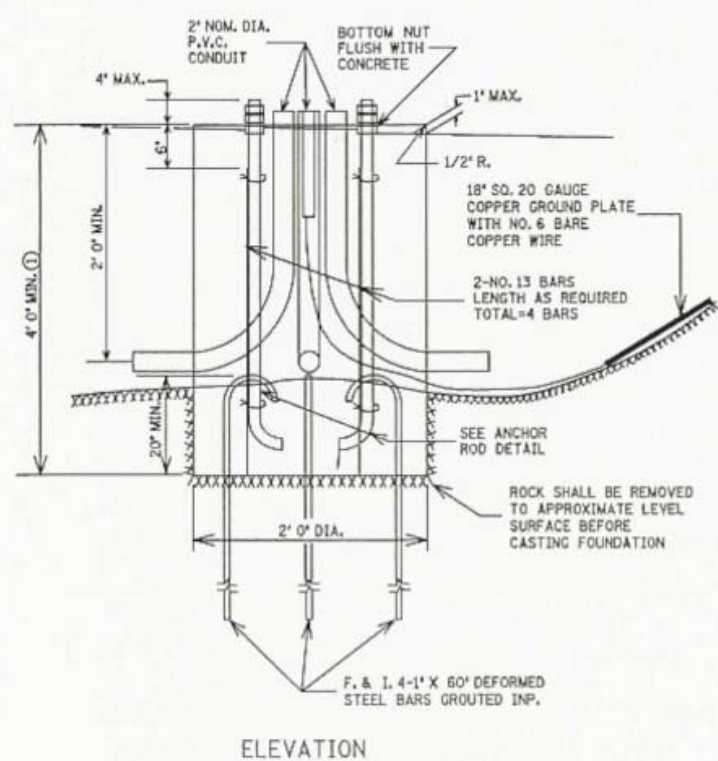
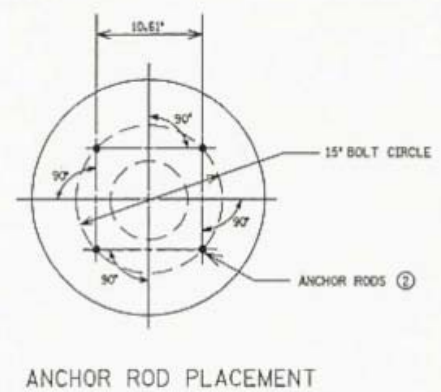
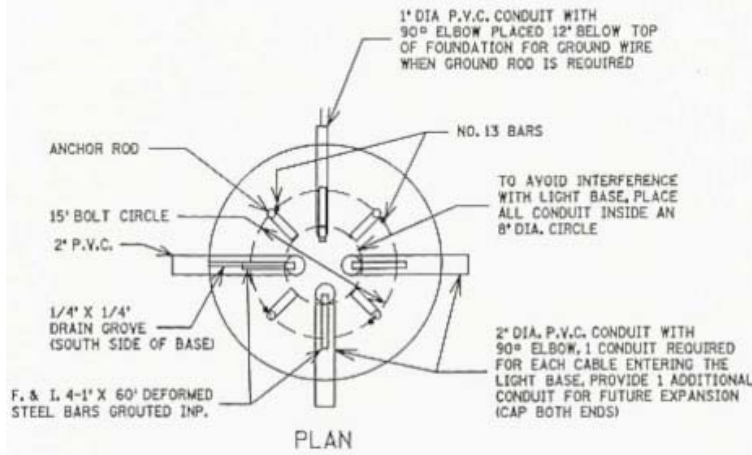

TYPICAL CONCRETE BASE IN ROCK
LIGHT BASE DESIGN R-40

- NOTES:
- CONCRETE SHALL BE MIX NO. 3Y43.
- FOUNDATIONS MAY BE CONSTRUCTED IN AUGURED HOLES UNLESS THE NATURAL SOILS WILL NOT STAND OPEN, IN WHICH CASE FORMING WILL BE REQUIRED.
- P.V.C. CONDUIT PER SPEC. 3803 SHALL BE PROJECTED 1" ABOVE THE FOUNDATION BEFORE THE MORTAR IS PLACED AND SHALL BE THE SIZE AND NUMBER SHOWN IN THE PLAN.
- A TEMPLATE SHALL BE PROVIDED FOR ANCHOR ROD PLACEMENT AND SHALL BE LEFT IN PLACE UNTIL THE CONCRETE HAS SET.
- ① THE DEPTH OF THE FOUNDATION MAY BE CHANGED IN THE PLANS OR SPECIAL PROVISIONS.
 - ② ANCHOR RODS PER SPEC. 3385, TYPE B OR C SHALL BE PLACED AT RIGHT ANGLES TO THE DIRECTION OF THE MAST ARM. GALVANIZE THE TOP 1 FT. OF THE ANCHOR ROD AND NUTS PER SPEC. 3392.
 - ③ WRAP THREADS OF ANCHOR RODS BELOW BOTTOM NUT WITH 3 LAYERS OF PLASTIC ELECTRICAL TAPE.

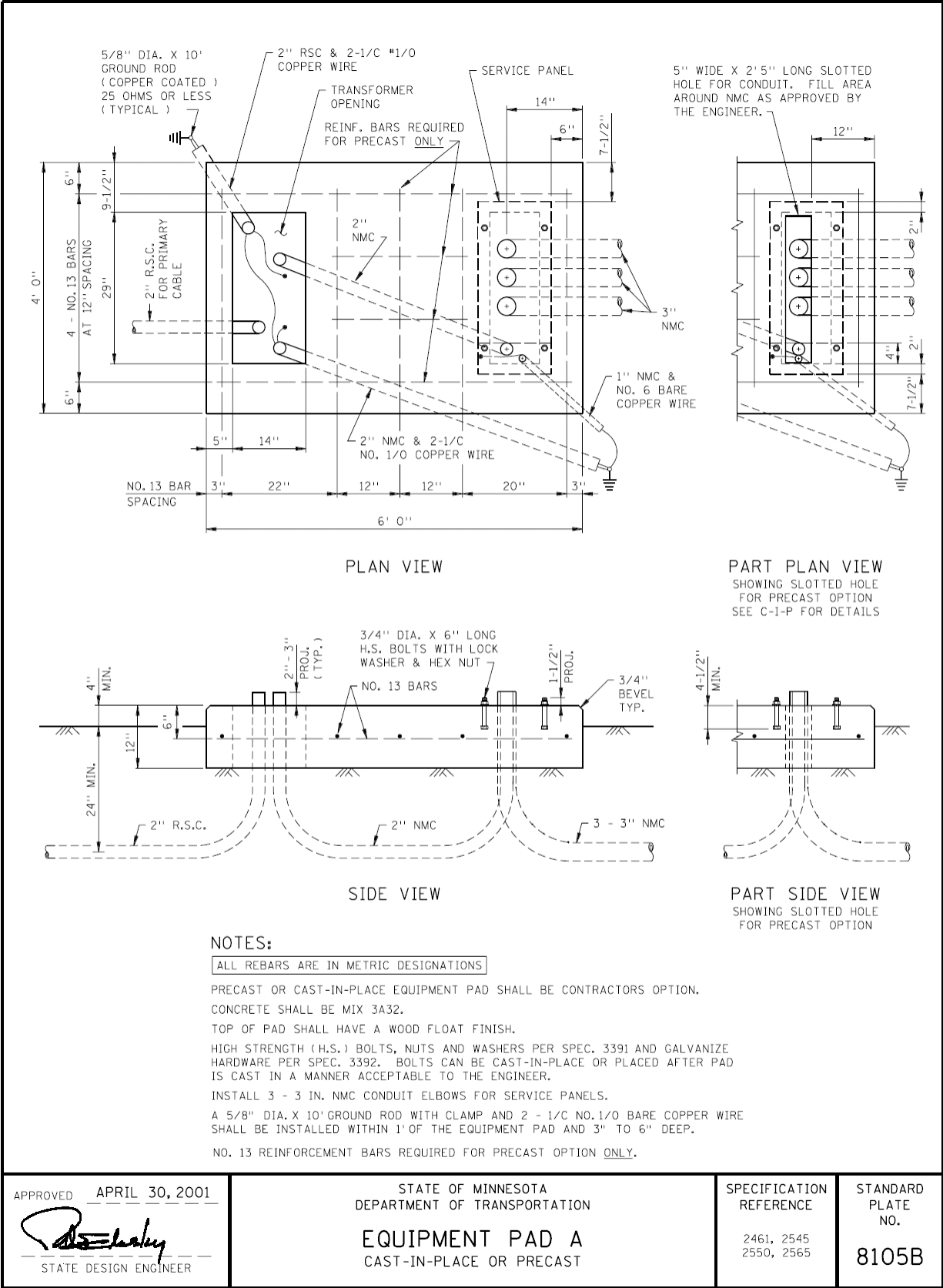

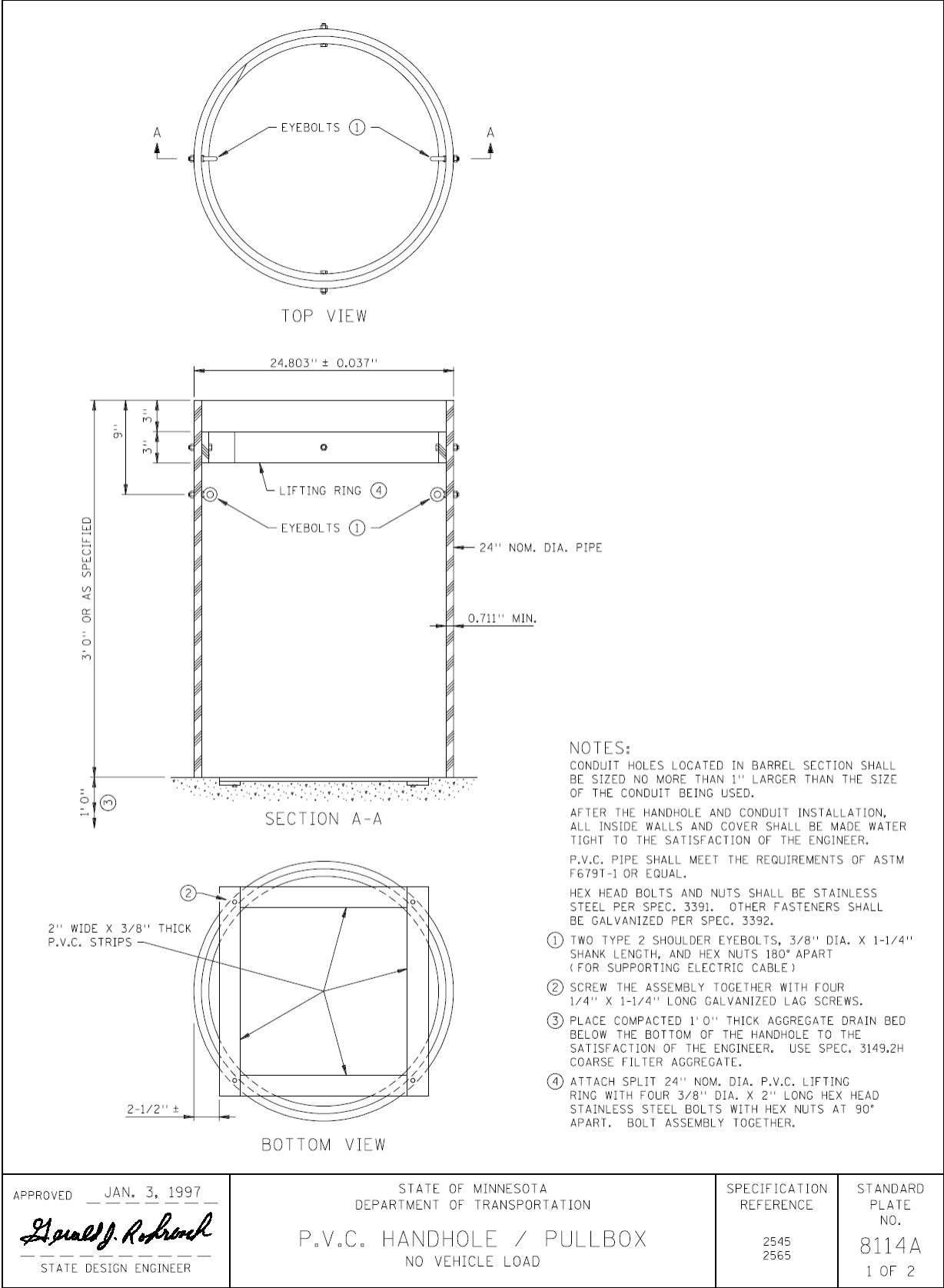

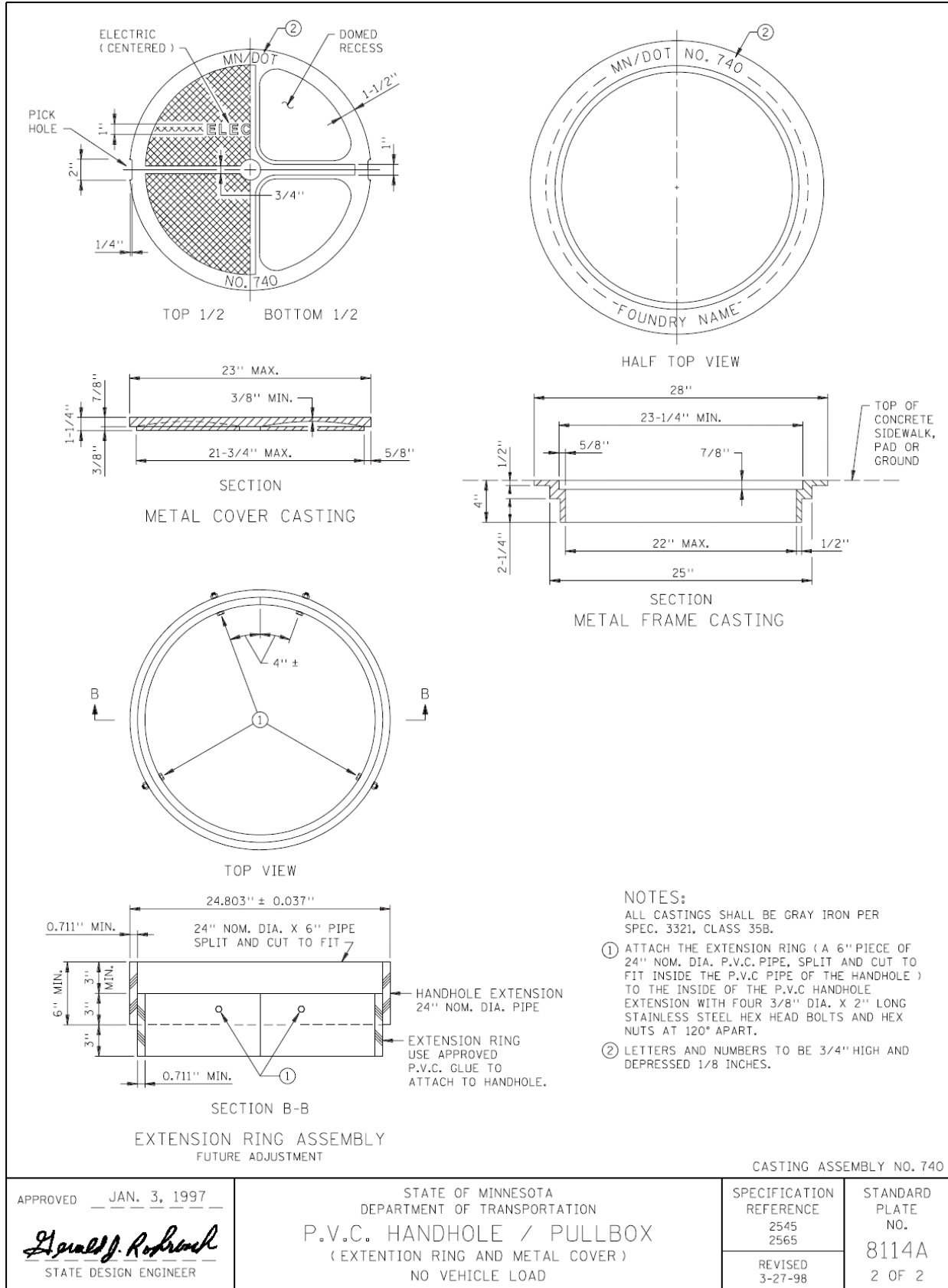

APPROVED JAN. 3, 1997

Donald J. Rodman
 STATE DESIGN ENGINEER

STATE OF MINNESOTA
 DEPARTMENT OF TRANSPORTATION
P.V.C. HANDHOLE / PULLBOX
 (EXTENSION RING AND METAL COVER)
 NO VEHICLE LOAD

SPECIFICATION REFERENCE
 2545
 2565
 REVISED 3-27-98

STANDARD PLATE NO.
8114A
 2 OF 2

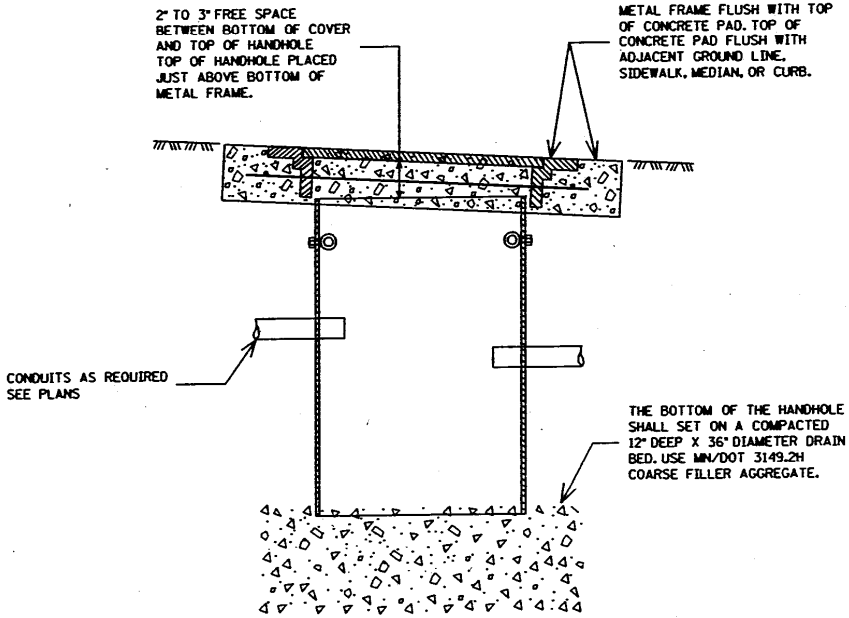
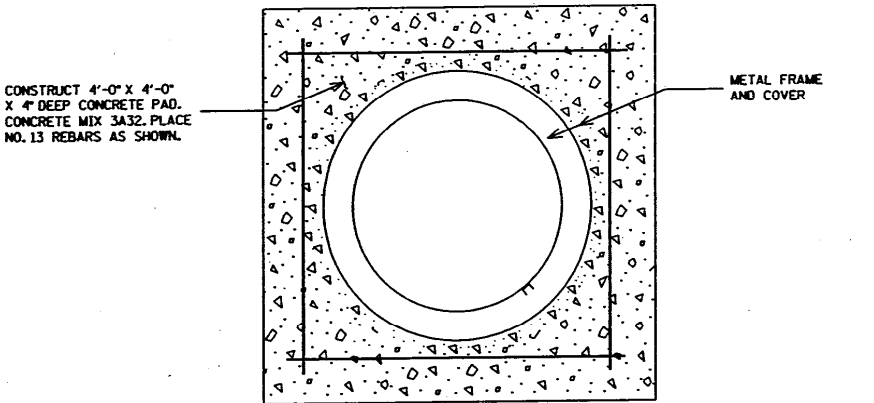

HANDHOLE WITH CONCRETE SURROUND
SEE STANDARD PLATE 8114 FOR
HANDHOLE CONSTRUCTION DETAILS

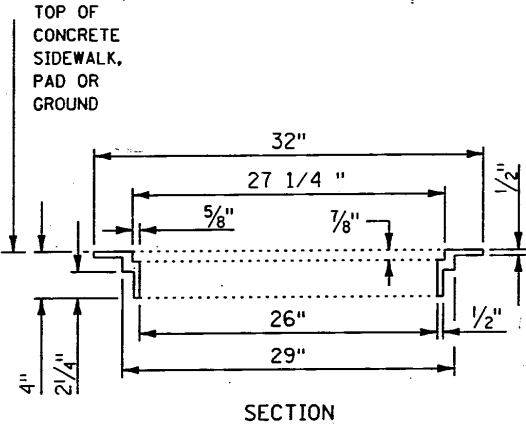
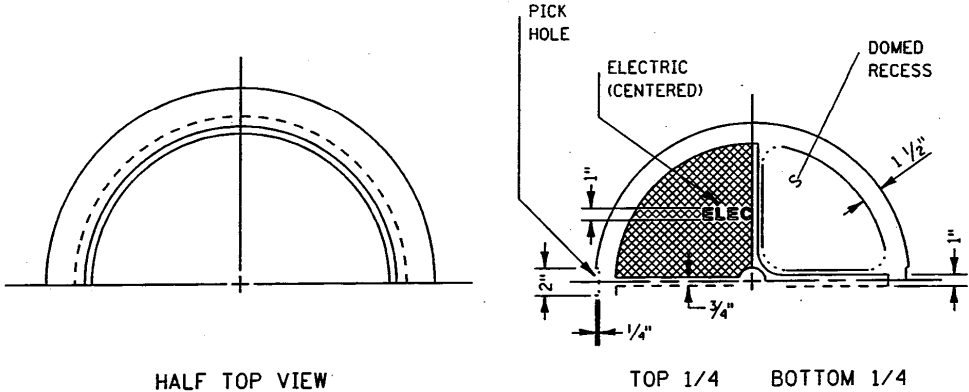

METAL FRAME CASTING

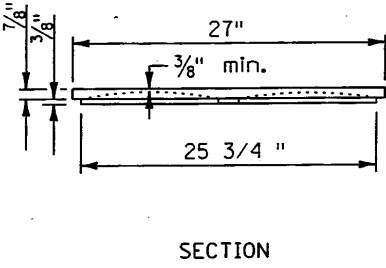

METAL COVER CASTING

- NOTE :
1. ALL CASTINGS SHALL BE GREY IRON AS PER SPEC. 3321, CLASS 35B.
 2. SPECIFICATION REFERENCE: 2545 & 2565.
 3. REFERENCE STANDARD PLATE NO. 8114 FOR DETAILS ON P.V.C. HANDHOLE/PULLBOX AND EXTENSION RING.

MODIFIED FRAME AND COVER CASTING DETAIL

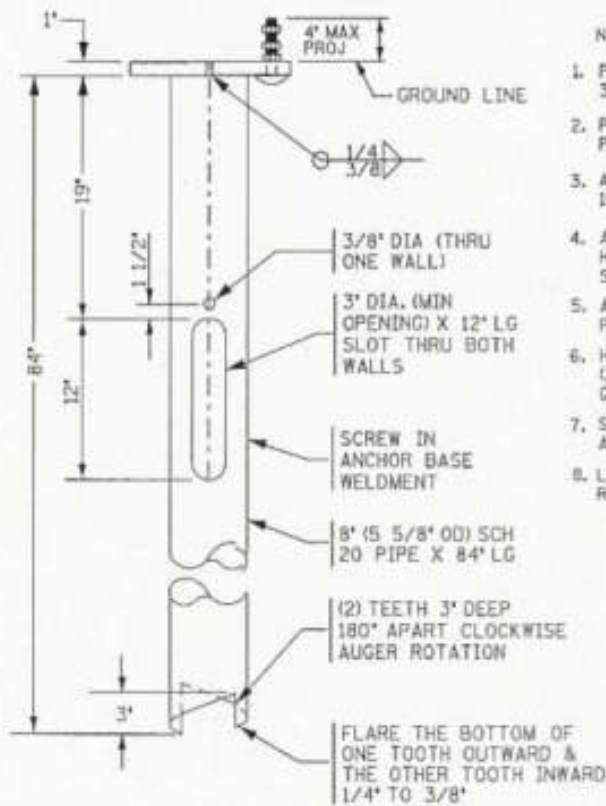
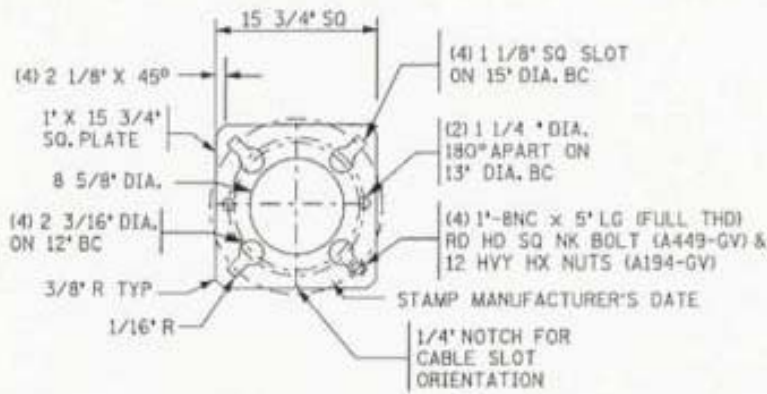

NOTES:

1. PLATE MATERIAL- LOW CARBON STEEL 36,000 PSI MIN YIELD PER ASTM A36
2. PIPE MATERIAL- 8" SCH 20 PIPE 35,000 PSI MIN. YIELD PER ASTM 53 GRB
3. ANCHOR BASE IS DESIGNED TO WITHSTAND 15,000 FT LBS OF INSTALLATION TORQUE.
4. ANCHOR BASE SHOULD BE SHIPPED WITH HARDWARE BAGGED AND SECURED TO PIPE SHAFT
5. ANCHOR BASE TO BE HOT DIP GALVANIZED PER ASTM A123
6. HEAVY HEX NUTS PER ASTM A194 GR 2H L03 OVER SIZED FOR GALVANIZED STUD; GALVANIZED NUTS PER ASTM A153
7. SEE SPECIAL PROVISIONS FOR APPROVED MANUFACTURERS.
8. LEVELING OF LIGHTING UNIT AS RECOMMENDED BY MANUFACTURER

LIGHT BASE DESIGN STEEL (E)

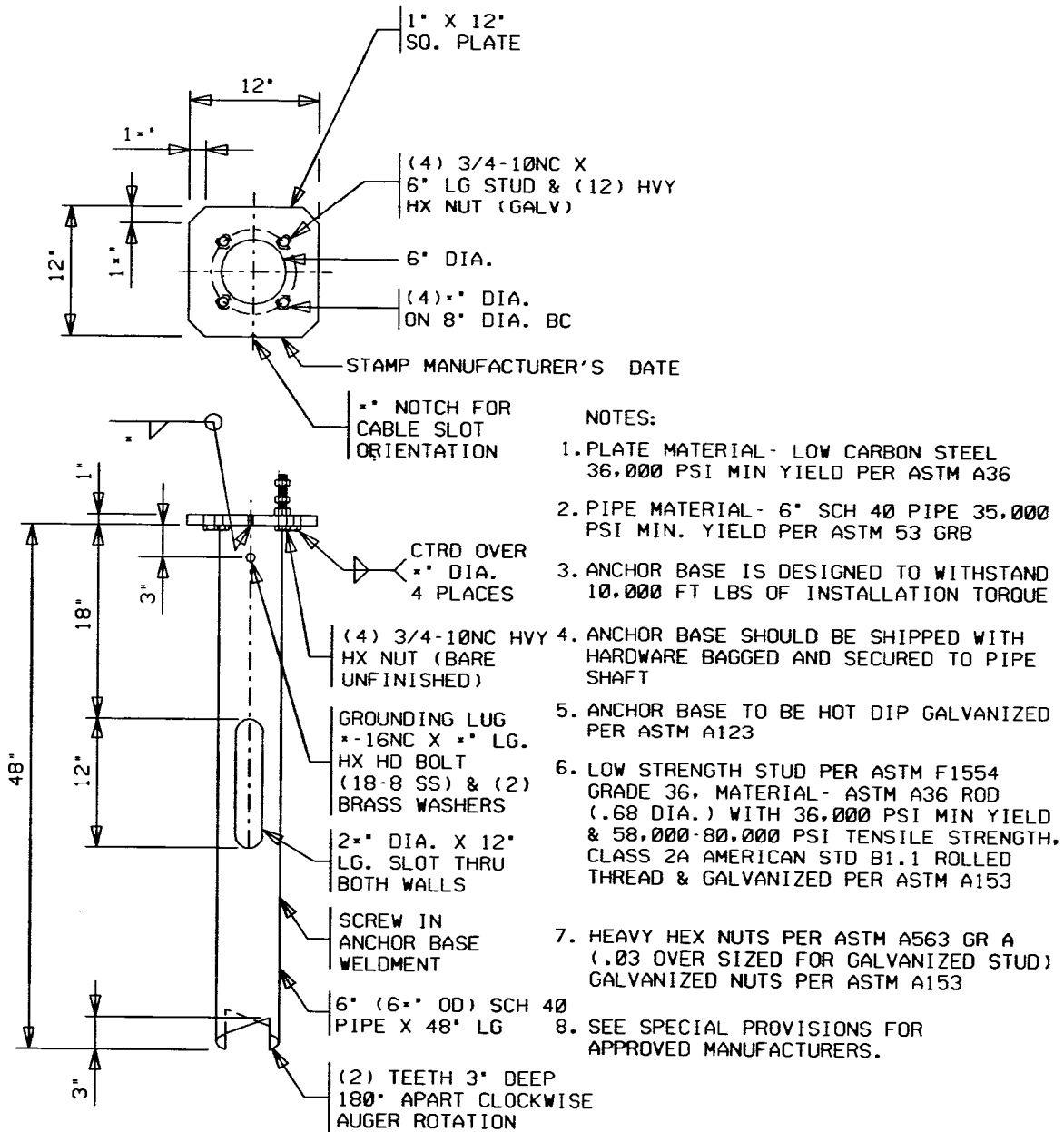

LIGHT BASE DESIGN STEEL (P)

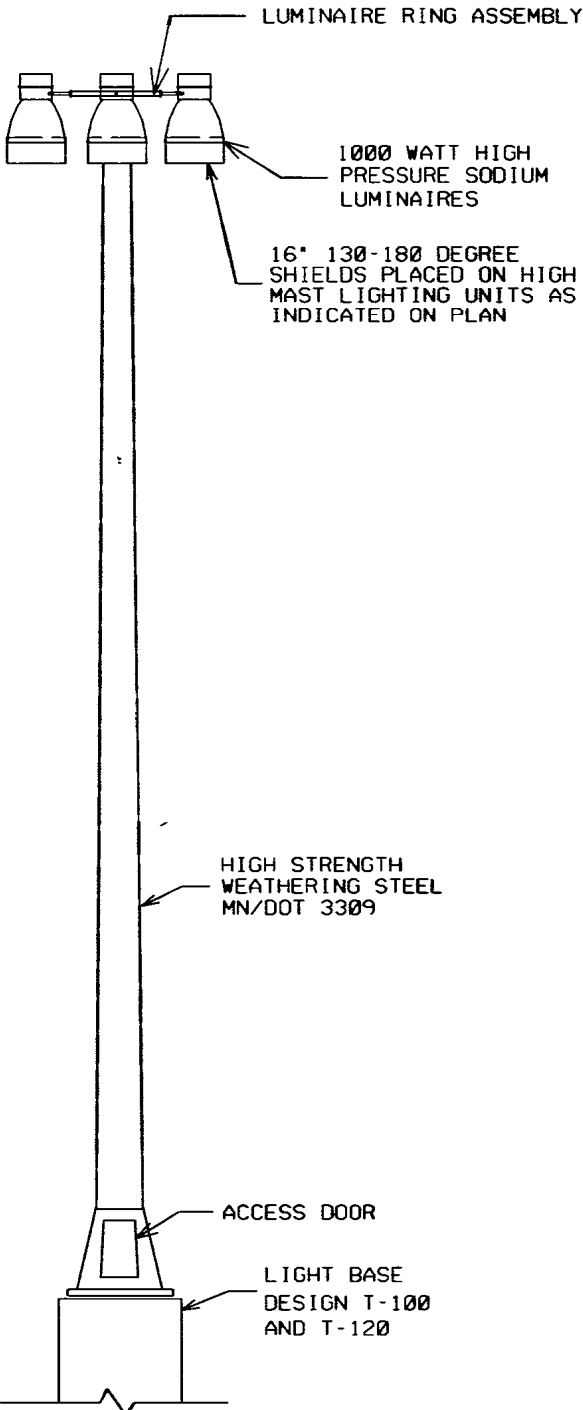

LIGHTING UNIT TYPE 3-100, AND 4-120

Appendix E - Sample Special Provisions

“SAMPLE” ROADWAY LIGHTING SYSTEM SPECIAL PROVISIONS (April 08, 2010)
This “sample” set of Lighting System Special Provisions will require editing (add, delete, modify, update, etc.) prior to use on a specific project.

DIVISION SL

The following paragraph is required for all Mn/DOT or State Aid project contracts. All RED text must be removed from the special provisions prior to the Special Provisions being submitted for project letting

SL-1 (1802) QUALIFICATION OF WORKERS

The provisions of Mn/DOT Specification 1802 are hereby supplemented with the following:

Signal and Lighting Certification will be required for all Contractors, Supervisors or Foremen involved in the field installation of the Traffic Signal and/or Lighting portion of this Project. Signal and Lighting Certification, Level II, is available through the Mn/DOT Technical Certification Program. Questions regarding certification or past certification may be directed to Technical Certification Coordinator at telephone (651) 366-4201.

SL-2 (2104) REMOVING MISCELLANEOUS STRUCTURES

SL-2.1 DESCRIPTION

This work shall consist of removing or salvaging miscellaneous structures in accordance with the provisions of Mn/DOT 2104 and the following:

Salvaged items shall be stored and protected from damage by the contractor until ready for reinstallation or delivery to storage. Any damage resulting from the Contractor's operations shall be repaired or replaced like in kind or better to that condition existing prior to the salvage operation.

Existing lighting service cabinets and other painted items may have been painted with lead-based paint. If this is the case, the Contractor shall be responsible for the proper handling, transportation, and disposal of these materials as hazardous waste and the handling, transportation, and disposal of these items shall be in accordance with Occupational Safety & Health Administration (OSHA) and the Minnesota Pollution Control Agency (MPCA) regulations.

The Contractor certifies that he or she is familiar with, and will comply with, the applicable requirements in OSHA 29 CFR 1926.62 and Minnesota Rules Chapter 5206, 7025, 7035, 7045 relating to disposal and/or the removal of these lead painted materials.

The Contractor shall provide to the Engineer a completed "Contractor Certification of Disposal" form included elsewhere in these Special Provisions.

SL-2.2 MATERIALS

None

1-SL

“SAMPLE” ROADWAY LIGHTING SYSTEM SPECIAL PROVISIONS (April 08, 2010)
This “sample” set of Lighting System Special Provisions will require editing (add, delete, modify, update, etc.) prior to use on a specific project.

SL-2.3 CONSTRUCTION REQUIREMENTS

A. Remove Light Standard Base

Item 2104.509 (Remove Light Standard Base) shall consist of removing the in place light standard bases as indicated in the Plan. All holes remaining from the removal of the light standard base must be backfilled in accordance with Mn/DOT 2545.3C.

B. Remove Cables

Item 2104.501 (Remove Armored Cable) shall consist of removing cables as directed by the Engineer. Removed cables shall become the property of the Contractor.

C. Remove Service Cabinet

Item 2104.509 (Remove Service Cabinet) shall consist of removing the in place service cabinet as indicated in the Plan. Removed service cabinet shall become the property of the Contractor.

D. Remove Lighting Unit

Item 2104.509 (Remove Lighting Unit) shall consist of removing the in place lighting units as shown in the Plan. The lighting unit includes pole, mast arm, luminaire, lamp, transformer base, and base anchorage. Wiring to removed lighting units shall be disconnected from any lighting units remaining in place. Removed lighting units shall become the property of the Contractor.

E. Remove Luminaire

Item 2104.509 (Remove Luminaire) shall consist of removing the in place luminaires, lamps, and ballasts located on the in place light standards as indicated in the Plan. Removed luminaires shall become the property of the Contractor.

F. Remove Equipment Pad

Item 2104.509 (Remove Equipment Pad) shall consist of removing the equipment pad as indicated in the Plan. All holes remaining from the removal of the equipment pad must be backfilled in accordance with Mn/DOT 2545.3C.

G. Salvage Service Cabinet

Item 2104.523 (Salvage Service Cabinet) shall consist of salvaging the in place service cabinet as indicated in the Plan. Salvaged service cabinet shall be delivered to storage location as specified herein, or as directed by the Engineer. Any damage to the salvaged materials resulting from the hauling operation shall be repaired and replaced at the Contractor's expense.

H. Salvage Lighting Unit

2-SL

“SAMPLE” ROADWAY LIGHTING SYSTEM SPECIAL PROVISIONS (April 08, 2010)
This “sample” set of Lighting System Special Provisions will require editing (add, delete, modify, update, etc.) prior to use on a specific project.

Item 2104.523 (Salvage Lighting Unit) shall consist of salvaging the lighting units as directed by the Engineer. The lighting unit includes pole, mast arm, luminaire, lamp, transformer base, and base anchorage. Wiring to the salvaged lighting units shall be disconnected from any lighting units remaining in place. Salvaged lighting units shall be delivered to storage location as specified herein, or as directed by the Engineer. Any damage to the salvaged materials resulting from the hauling operation shall be repaired and replaced at the Contractor's expense.

I. Blank

J. Salvage Luminaire

Item 2104.523 (Salvage Luminaire) shall consist of removing and salvaging the luminaires and lamps as indicated in the Plan. Salvaged luminaires shall be delivered to storage location as specified herein, or as directed by the Engineer. Any damage to the salvaged luminaires resulting from the hauling operation shall be repaired and replaced at the Contractor's expense.

K. Salvage Steel Light Base

Item 2104.523 (Salvage Steel Light Base) shall consist of removing and salvaging the steel light bases as directed by the Engineer. The steel light bases must be cleaned of all dirt and debris before delivery to storage. All holes remaining from the removal of the steel light base must be backfilled in accordance with Mn/DOT 2545.3C. Salvaged steel light base shall be delivered to storage location as specified herein, or as directed by the Engineer. Any damage to the salvaged materials resulting from the hauling operation shall be repaired and replaced at the Contractor's expense.

(The following language is used for Non-Federally Funded Projects Only)

All Red text must be removed from the special provisions prior to the special provisions being submitted for project letting.

L. Delivery of Salvaged Materials

Salvaged materials shall be disassembled as directed by the Engineer and, unless otherwise specified, shall be delivered to the Department at the Electrical Services Section (ESS), 6000 Minnehaha Avenue, St. Paul, MN., 55111. The Contractor shall notify Mr. Mike Schroeder (651-366-5719) of Mn/DOT Electrical Services Section at least three (3) normal working days in advance of the time the Contractor intends to deliver the salvaged materials. **THE ENGINEER SHALL BE NOTIFIED IN ADVANCE OF NOTIFICATION TO MR. SCHROEDER.**

The Contractor shall obtain a salvaged material receipt from the Mn/DOT Central Electrical Inventory Center indicating that Mn/DOT has received the salvaged material. The Contractor shall give the project Engineer a copy of this receipt for the permanent project records.

(The following Section to be used for Federally Funded Lighting Projects Only)

All Red text must be removed from the special provisions prior to the special provisions being submitted for project letting.

3-SL

“SAMPLE” ROADWAY LIGHTING SYSTEM SPECIAL PROVISIONS (April 08, 2010)
This “sample” set of Lighting System Special Provisions will require editing (add, delete, modify, update, etc.) prior to use on a specific project.

SL-3 (2104) HAUL SALVAGED MATERIAL

This work shall consist of loading and hauling materials designated for salvage and storage in accordance with the provisions of Mn/DOT 2104 and the following:

Salvaged materials shall be disassembled as directed by the Engineer and shall be delivered to the Department at the Electrical Services Section (ESS), 6000 Minnehaha Avenue, St. Paul, MN., 55111. The Contractor shall notify Mr. Mike Schroeder (651-366-5719) of Mn/DOT Electrical Services Section at least three (3) normal working days in advance of the time the Contractor intends to deliver the salvaged materials. **THE ENGINEER SHALL BE NOTIFIED IN ADVANCE OF NOTIFICATION TO MR. SCHROEDER.**

Any damage to the salvaged materials resulting from the hauling operation shall be repaired and replaced at the Contractor's expense.

The Contractor shall obtain a salvaged material receipt from the Mn/DOT Central Electrical Inventory Center indicating that Mn/DOT has received the salvaged material. The Contractor shall give the project Engineer a copy of this receipt for the permanent project records.

All hauling of salvaged materials to the Department at the location specified herein shall be paid for under Item No. 2104.601 (HAUL SALVAGED MATERIAL) at the contract LUMP SUM price which shall be payment in full for all costs relative to hauling the materials to, and depositing the materials, at the location specified herein.

SL-4 (2545) ELECTRIC LIGHTING SYSTEMS

This work shall consist of furnishing labor, equipment, and materials for construction of an electric lighting system in accordance with the applicable provisions of Mn/DOT 2471, Mn/DOT 2545, current edition of the National Electric Code, the Plans, and the following:

SL-4.1 GENERAL

A. "As Built Plans"

The Contractor shall furnish "as built Plans" that contain any changes in the following:

- Cable locations.
- Conduit locations.
- Light pole locations.
- Feedpoint locations.
- Handhole locations.

Any discrepancy or additions between the final plan and how the lighting system was actually built **must be indicated** on the "as built plan".

4-SL

“SAMPLE” ROADWAY LIGHTING SYSTEM SPECIAL PROVISIONS (April 08, 2010)
This “sample” set of Lighting System Special Provisions will require editing (add, delete, modify, update, etc.) prior to use on a specific project.

The “as built Plans” shall be in a form that is satisfactory to the Engineer. The Contractor furnished “as built Plans” shall be considered incidental work.

B. Maintain Existing Street Lighting

Except during any periods of authorized work suspension, the Contractor shall be responsible for all maintenance of the existing lighting system within the limits of the construction project in accordance with the applicable provisions of Mn/DOT 1514. This maintenance shall include: lighting units, luminaires, lamps (after 30% or more of the lamps are burned out), lighting service cabinet(s), photoelectric controls, foundations (concrete or steel), cable, and damage and knockdowns (due to Contractor operations) until final written acceptance of the project by the Engineer (Mn/DOT 1716). This work shall be considered incidental work.

Any damage, that in the opinion of the Engineer, has occurred by someone, other than the Contractor operation, shall be maintained and repaired by the Contractor and will be paid for in accordance with Mn/DOT 1403 (EXTRA WORK).

During any periods of authorized work suspension, the Department will provide and maintain all items of the existing lighting system.

THE CONTRACTOR SHALL FURNISH TO THE DEPARTMENT THE NAMES AND PHONE NUMBERS OF CONTACT PERSONNEL FOR BOTH DAY AND NIGHT OPERATION FOR THE MAINTENANCE OF THE EXISTING LIGHTING SYSTEM.

C. Temporary Lighting System

The Contractor shall install the State-furnished and other materials described within the specifications at the jobsite and as directed by the Engineer. The Contractor shall also furnish and install all additional materials and electrical equipment needed to provide a complete and operating temporary lighting system. These materials may include but are not limited to: risers, weatherheads, conduit and conduit fittings, ground rod electrodes and cable, bonding and grounding materials and connections, and galvanized steel strapping.

The cost of any additional contractor-furnished materials and the cost of the labor for their installation shall be considered incidental to the cost of the temporary lighting system.

The Contractor shall pay all power costs including any extension of power lines by the Power Company, and shall maintain the temporary lighting system in good working order throughout the duration of the contract, this includes but not limited to knockdowns, light pole hits, and luminaire or lamp failures. All costs incurred shall be incidental to the cost of the Project.

D. Locating Underground Utilities

The Contractor must adhere to all requirements of Gopher State One Call including the

5-SL

“SAMPLE” ROADWAY LIGHTING SYSTEM SPECIAL PROVISIONS (April 08, 2010)
This “sample” set of Lighting System Special Provisions will require editing (add, delete, modify, update, etc.) prior to use on a specific project.

following:

The Contractor is responsible for marking the proposed excavation area by utilizing white markings. The white markings must delineate the actual excavation area where the locating of underground facilities is required.

SL-4.2 MATERIALS

A. Shop Drawings

THE CONTRACTOR SHALL PROVIDE SHOP DETAIL DRAWINGS FOR ALL MATERIALS AND ELECTRICAL EQUIPMENT AS SPECIFIED IN THE CONTRACT DOCUMENT.

B. Conduit

The Contractor shall furnish and install either rigid steel conduit (R.S.C.) or non-metallic conduit (N.M.C.) at the locations indicated in the Plans. The size of the conduit shall be as indicated in the Plan. All conduit shall be in accordance with the following:

1. Rigid Steel Conduit (R.S.C.):

Shall be in accordance with Mn/DOT 3801.

2. Non-Metallic Conduit:

Shall be in accordance with Mn/DOT 3803, except as follows:

- a. Shall be Schedule 80 conduit and fittings for all installations.
- b. For HDPE continuous type conduit, all conduit fittings shall be appropriate for use with HDPE continuous length conduit.
- c. Shall be capable of being installed by plowing, trenching, or directional boring methods.
- d. Shall be either “GREY” or “RED” in color.
- e. Shall be marked on the outside of conduit indicating manufacturer’s name, size of conduit, type of conduit (HDPE, etc.), ASTM F 2160, UL Listing, and any other markings required by the N.E.C.
- f. Before the cables and conductors are installed, non-metallic conduit bell ends (**appropriately sized for the HDPE type conduit**) shall be installed to prevent damage to the cables and conductors

6-SL

“SAMPLE” ROADWAY LIGHTING SYSTEM SPECIAL PROVISIONS (April 08, 2010)
This “sample” set of Lighting System Special Provisions will require editing (add, delete, modify, update, etc.) prior to use on a specific project.

All conduit from concrete foundations to the nearest handhole shall be either rigid steel conduit (R.S.C) or rigid non-metallic conduit (N.M.C.), **HDPE continuous length conduit is not allowed for use between concrete foundations and the nearest handhole.**

C. Handholes

New Handholes shall be Mn/DOT approved Handholes and Handhole Covers listed on the Mn/DOT Approved/Qualified Products Lists WEB site for Signals:

<http://www.dot.state.mn.us/products/index.html>

D. Luminaire Wire Holder

The Contractor shall furnish and install a wire holder that supports the luminaire cable/conductors within the end of the luminaire slipfitter near the connection point of the luminaire. Mn/DOT approved Wire Holders are listed on the Mn/DOT Approved/Qualified Products Lists WEB site for Lighting:

<http://www.dot.state.mn.us/products/index.html>

(The following Section should be included when you want to use Standard Life Lamps)
All Red text must be removed from the special provisions prior to the special provisions being submitted for project letting.

E. Lamps

Lamps for luminaires shall be in accordance with the provisions of Mn/DOT 2545.2F4.

Mn/DOT approved Lamps are listed on the Mn/DOT Approved/Qualified Products Lists WEB site for Lighting:

<http://www.dot.state.mn.us/products/index.html>

(The following Section should be included when you want to use Extended Life Lamps)
All Red text must be removed from the special provisions prior to the special provisions being submitted for project letting.

F. Extended Life Lamps

The Contractor shall furnish and install Extended Life Lamps in each new luminaire and as specified herein and in the Plan, mark the date of installation with a “black oil based paint marker” on the lamp socket base; provide and install all wiring, connections, and miscellaneous hardware required to bypass the existing igniter in the luminaire in accordance with manufacturers directions for a complete and operating lamp installation.

7-SL

“SAMPLE” ROADWAY LIGHTING SYSTEM SPECIAL PROVISIONS (April 08, 2010)
This “sample” set of Lighting System Special Provisions will require editing (add, delete, modify, update, etc.) prior to use on a specific project.

Mn/DOT approved Extended Life Lamps are listed on the Mn/DOT Approved/Qualified Products Lists WEB site for Lighting:

<http://www.dot.state.mn.us/products/index.html>

G. Aboveground Splices

Aboveground splices shall be in accordance with the provisions of Mn/DOT 2545.3G4 and 2565.3J4. When above ground splices are allowed, the Contractor may substitute approved insulated wire splice connector blocks for the specified “split bolt” connector:

Mn/DOT approved Insulated Wire Splice Connector Blocks are listed on the Mn/DOT Approved/Qualified Products Lists WEB site for Lighting:

<http://www.dot.state.mn.us/products/index.html>

The Contractor shall apply two layers of protective vinyl electrical tape over the insulated wire splice connector blocks in the area where the conductors enter the block and extend the wrap at least one (1) inch over the incoming conductor insulation.

H. Above Ground Wiring

Above ground wiring in roadway lighting standards shall be in accordance with Mn/DOT 2545.3G3 and as follows:

The term “14-2 UF” shall be deleted the term “12-2 UF with ground” shall be inserted.

Fuse holders shall be of the breakaway type.

Shall have 6 amp fuses when a 240/480 volt system is installed and 8 amp fuses when a 120/240 volt system is installed.

Mn/DOT approved Fuse Holders are listed on the Mn/DOT Approved/Qualified Products Lists WEB site for Lighting:

<http://www.dot.state.mn.us/products/index.html>

After the conductors have been crimped to the fuse holder the Contractor shall apply two layers of protective vinyl electrical tape over the breakaway fuse holder in the area where the conductors are crimped to the fuse holder. Cover any un-insulated portion of the fuse holder barrel and extend the wrap at least one (1) inch over the incoming conductor insulation.

I. Blank

J. Underground Cable Splice

8-SL

“SAMPLE” ROADWAY LIGHTING SYSTEM SPECIAL PROVISIONS (April 08, 2010)
This “sample” set of Lighting System Special Provisions will require editing (add, delete, modify, update, etc.) prior to use on a specific project.

The following text should be used when the project calls for a direct buried underground splice that is not placed in a handhole:
All Red text must be removed from the special provisions prior to the special provisions being submitted for project letting.

a. Underground Cable Splice Direct Buried

The Contractor shall furnish and install a direct buried underground cable splice in accordance with the provisions of Mn/DOT 2545.3G4 and as follows:

1. Shall have each individual cable spliced together using a NRTL listed compression –type butt splice barrel connector that is rated for the size of conductor being spliced.
2. Shall use the manufacturer specific compression tool for crimping the barrel connector to the conductors.
3. Shall cover the entire wire splice with appropriately sized shrink tubing. The shrink tubing shall also cover a minimum of ¼ inch of the conductor insulation on both sides of the splice. After the tubing is slid into position to properly cover the splice it must be heated and shrunk to form a tight seal around the splice and the insulation of the conductor on both sides of the splice.
4. Shall wrap each conductor splice after compression and installation of the shrink tubing with at least two layers of electrical tape to insulate individual conductors prior to encapsulation.
5. Shall have the armor spliced together by drilling a hole in each piece of armor and then bolting the pieces together with brass nuts and bolts and flat washers to form an electrical bond between the two pieces. The bolt head must be facing the cables and the shaft of the bolt must be facing outward.
6. Shall have all splices assembled per the manufacturers installation instructions.
7. Shall place the entire cable splice inside the approved power cable splice encapsulation kit such that when the encapsulating material is poured in the mold it seals up the conductor splices, cable armor and the outer jacket of the armored cable to form one complete assembly. There should be no individual conductor insulation or cable armor exposed when the splice is complete.
See the picture below for an example of a partially assembled splice prior to casting.

Mn/DOT approved Power Cable Splice Encapsulation Kits are listed on the Mn/DOT Approved/Qualified Products Lists WEB site for [Lighting](http://www.dot.state.mn.us/products/index.html):

<http://www.dot.state.mn.us/products/index.html>

8. The power cable splice encapsulation kit shall be assembled per the manufacturer’s installation instructions and as follows:
 - a. Wrap electrical insulating tape around the end of each funnel assembly where it

9-SL

“SAMPLE” ROADWAY LIGHTING SYSTEM SPECIAL PROVISIONS (April 08, 2010)
This “sample” set of Lighting System Special Provisions will require editing (add, delete, modify, update, etc.) prior to use on a specific project.

meets the cable assemble outer jacket to prevent epoxy from leaking out of the mold prior to curing.



9. Shall allow the resin to harden and cool after which all conductors of the splice shall be tested and found in compliance with Mn/DOT 2545.3K1

The following text should be used when the project calls for a 2 way cable splice in a handhole: A typical use would be to feed a branch circuit for underpass lighting from a handhole.
All Red text must be removed from the special provisions prior to the special provisions being submitted for project letting.

b. Two Way Underground Handhole Cable Splice

The Contractor shall furnish and install a two way underground handhole cable splice in accordance with the provisions of Mn/DOT 2545.3G4 and as follows:

1. Shall have adequate slack in the cable assembly to allow each individual cable to extend at least 3 feet above the top of the hand hole prior to stripping the cable.
2. Shall strip off the outer jacket of the cable assembly to within 6 inches of where the cable enters the handhole.
3. Shall un-wrap the bronze armor to within 6 inches of where the cable enters the hand hole.
4. Shall have armor spliced together by drilling a hole in each piece of armor and then bolting the pieces together with brass nuts, bolts and flat washers to form an electrical bond between the two pieces of bronze armor.
5. Shall apply pole base terminal block coating to the entire armor splice point.

10-SL

“SAMPLE” ROADWAY LIGHTING SYSTEM SPECIAL PROVISIONS (April 08, 2010)
This “sample” set of Lighting System Special Provisions will require editing (add, delete, modify, update, etc.) prior to use on a specific project.

Mn/DOT approved Pole Base Terminal Block Coatings are listed on the Mn/DOT Approved/Qualified Products Lists WEB site for Signals:

<http://www.dot.state.mn.us/products/index.html>

6. Shall splice each individual conductor of the 4 conductor cable assemblies separately.
7. Shall maintain proper circuit color identification within each splice.
8. Shall splice each conductor pair together using a NRTL listed compression –type butt splice barrel connector that is rated for the size of cable being spliced.
9. Shall use the manufacturer specific compression tool for crimping the barrel connector to the conductors.

10. Each individual conductor splice shall be separately encapsulated with a loop detector splice encapsulation kit.

Mn/DOT approved Loop Detector Splice Encapsulation Kits are listed on the Mn/DOT Approved/Qualified Products Lists WEB site for Signals:

<http://www.dot.state.mn.us/products/index.html>

11. The loop detector splice encapsulation kit shall be assembled per the manufacturer’s installation instructions and as follows:
 - a. Wrap electrical insulating tape around the end of each of the funnel assembly where it meets the conductor to prevent epoxy from leaking out of the mold prior to curing.



11-SL

“SAMPLE” ROADWAY LIGHTING SYSTEM SPECIAL PROVISIONS (April 08, 2010)
This “sample” set of Lighting System Special Provisions will require editing (add, delete, modify, update, etc.) prior to use on a specific project.

12. Shall allow the resin to harden and cool after which all conductors of the splice shall be tested and found in compliance with Mn/DOT 2545.3K1

The following text should be used when the project calls for a 3 way cable splice in a handhole: A typical use would be to feed a branch circuit for underpass lighting from a handhole.
All Red text must be removed from the special provisions prior to the special provisions being submitted for project letting.

c. Three Way Underground Handhole Cable Splice

The Contractor shall furnish and install a three way underground handhole cable splice in accordance with the provisions of Mn/DOT 2545.3G4 and as follows:

1. Shall have adequate slack in the cable assembly to allow each individual cable to extend at least 3 feet above the top of the hand hole prior to stripping the cable.
2. Shall strip off the outer jacket of the cable assembly to within 6 inches of where the cable enters the hand hole.
3. Shall un-wrap the bronze armor to within 6 inches of where the cable enters the hand hole.
4. Shall have armor spliced together by drilling a hole in each piece of armor and then bolting the pieces together with brass nuts, bolts and flat washers to form an electrical bond between the three pieces of bronze armor.
5. Shall apply pole base terminal block coating to the entire armor splice point
Mn/DOT approved Pole Base Terminal Block Coatings are listed on the Mn/DOT Approved/Qualified Products Lists WEB site for Signals:
<http://www.dot.state.mn.us/products/index.html>
6. Shall splice each individual conductor of the 4 conductor cable assemblies separately.
7. Shall maintain proper circuit color identification within each splice.
8. Shall splice the three conductors together using a NRTL listed Split Bolt splice connector that is rated for the size and number of the conductors being spliced.
9. Shall insure the split bolt is adequately tightened.
10. Each individual conductor splice shall be separately encapsulated with a 3 way power cable

12-SL

“SAMPLE” ROADWAY LIGHTING SYSTEM SPECIAL PROVISIONS (April 08, 2010)
This “sample” set of Lighting System Special Provisions will require editing (add, delete, modify, update, etc.) prior to use on a specific project.

splice encapsulation kit.

Mn/DOT approved 3 Way Power Cable Splice Encapsulation Kits are listed on the Mn/DOT Approved/Qualified Products Lists WEB site for Lighting:

<http://www.dot.state.mn.us/products/index.html>

11. The 3 way power cable splice encapsulation kits shall be assembled per the manufacturer’s installation instructions and as follows:

- a. Wrap electrical insulating tape around the end of each Y on the assembly where it meets the conductor to prevent epoxy from leaking out of the mold prior to curing.



12. Shall allow the resin to harden and cool after which all conductors of the splice shall be tested and found in compliance with Mn/DOT 2545.3K1

K. Overhead Light Cable 4 Conductor No. 4

The Contractor shall furnish and install Overhead Light Cable 4 Cond. No. 4 for overhead

13-SL

“SAMPLE” ROADWAY LIGHTING SYSTEM SPECIAL PROVISIONS (April 08, 2010)
This “sample” set of Lighting System Special Provisions will require editing (add, delete, modify, update, etc.) prior to use on a specific project.

distribution circuits. The overhead light cable shall be in accordance with Mn/DOT 3815.

Within 15 days after the Contract approval notice mailing date, the Contractor shall furnish evidence to the Engineer, in writing, that orders have been placed for all armored cable required.

L. Armored Underground Cable

Specification 3815.2C1 is hereby deleted. Armored underground cable shall be in accordance with the following:

1. Shall be listed as meeting the requirements of UL 44 and 1277.
2. Shall meet the requirements of ICEA S-95-658 (NEMA WC 70).
3. Shall have four conductors # 4 AWG.
4. Conductors shall be Class C (19 strand) soft drawn, bare copper wires per ASTM B3 and ASTM B 8.
5. Shall be suitable for use in cable trays, aerial, or direct burial installations
6. Shall be rated for 600 Volts
7. Shall be heat resistant.
8. Shall be moisture resistant.
9. Shall be sunlight resistant.
10. Shall have insulation acceptable for use in wet or dry locations at 90°C.
11. Shall have insulated conductors with chemically cross-linked thermosetting polyethylene (XLPE) insulation.
12. Shall have individual conductors constructed with circuit identification in accordance with method 1 of ICEA S-73-532 (NEMA WC-57) Table E-1 (Black, White, Red and Green) .
13. Shall have a bronze tape armor wrapped around the binder tape and under the outer jacket
The armor shall be a single thickness bronze tape meeting ASTM B 130 with a minimum thickness of 254 µm (0.01 inch) and a spiral overlap of not less than 6.35 mm (0.25 inch).
14. Shall have a polyvinyl chloride (PVC) outer jacket.
15. The jacket shall have a minimum average thickness of 2.03 mm (80 mils) and a minimum thickness at any point of 1.62 mm (64 mils).
16. Shall be constructed using a tape binder
17. Shall have non-hygroscopic fillers used in the interstices of the cable where necessary to give the completed cable assembly a circular cross-section. Fillers made of Jute or Paper are not acceptable.
18. Shall have an outer cable jacket that has a substantially circular cross-section. The outer cable jacket shall not be convoluted and shall not have a rope appearance.
19. Shall have the outer jacket surface ink printed with the following information:
 - a. Manufacturer Name
 - b. Year of Manufacture (Date Code)
 - c. Type of Cable (i.e. TC SHIELDED, XHHW-2)
 - d. Size and Number of Conductors (i.e. 4/C #4)
 - e. Voltage rating
 - f. Conductor Insulation Rating

14-SL

“SAMPLE” ROADWAY LIGHTING SYSTEM SPECIAL PROVISIONS (April 08, 2010)
This “sample” set of Lighting System Special Provisions will require editing (add, delete, modify, update, etc.) prior to use on a specific project.

- g. Labeled UL Listed
- h. Labeled as sunlight resistant (Sun Res) and direct burial (Dir Bur)
- i. Foot markers

Within 15 days after the Contract approval notice mailing date, the Contractor shall furnish evidence to the Engineer, in writing, that the orders have been placed for all cable required.

M. Light Base, Design E

The Contractor shall furnish and install a concrete Light Base, Design E in accordance with Mn/DOT 2545.3F and Mn/DOT Standard Plate 8127, at the locations indicated in the Plan.

Except in paved areas, and with approval by the Engineer, the Contractor may furnish and install, as an alternative to the concrete Light Base Design E, a Light Base, Design Steel E. The Light Base, Design Steel E shall be as follows:

The Contractor shall furnish and install a Light Base, Design Steel E at the locations indicated in the Plan.

Mn/DOT approved Light Bases Design Steel E are listed on the Mn/DOT Approved/Qualified Products Lists WEB site for Lighting:

<http://www.dot.state.mn.us/products/index.html>

The base plate is to be machine smooth cut both on the external edges and on the inner hole that provides access to the foundation shaft interior. During the fabricating process, the foundation type stamp is to be permanently and plainly marked on the top in a highly visible manner.

The foundation shaft is to be machine smooth-flame cut to length. Cableway openings shall be machine smooth-cut on both sides of the shaft 180 degrees apart. The cableway openings are to be parallel to the axis of the shaft +/- 1/2 degrees as measured along their full length. The minimum torque capacity indicated on the drawing for the entire foundation assembly shall take into account any diminished value that would be dictated by the cableway openings in the shaft. The appropriate edges/areas of the shaft are to be mechanically cleaned before the prescribed welding operations.

“SAMPLE” ROADWAY LIGHTING SYSTEM SPECIAL PROVISIONS (April 08, 2010)
This “sample” set of Lighting System Special Provisions will require editing (add, delete, modify, update, etc.) prior to use on a specific project.

The Light Base, Design Steel E is acceptable for installation in the following soils:

SOIL DESCRIPTIONS	Probe Values in.-lbs. (N/m)	Typical Blow Count "N" per ASTM-D1586
Dense sands, and gravel; hard silts and clays.	500-600 (65-78)	35-50
Medium dense sandy gravel; very stiff to hard silts and clays.	400-500 (52-65)	24-40
Medium dense coarse sand and sandy gravel; stiff to very stiff silt and clays.	300-400 (39-52)	14-25
Loose to medium dense fine to coarse sand; firm to stiff clays and silts.	200-300 (26-39)	7-14

N. Light Base, Design E Modified

The Contractor shall furnish and install a Light Base, Design E Modified at locations shown in the Plan. The Light Base, Design E Modified shall be in accordance with Mn/DOT 2545.3F and Mn/DOT Standard Plate 8127B except that it shall be modified to fit the bolt circle specific to the light pole manufacturer as detailed in the shop drawings to be provided.

O. Blank

P. Light Base, Design Steel E

The Contractor shall furnish and install a Light Base, Design Steel E at the locations indicated in the Plan.

Mn/DOT approved Light Bases Design Steel E are listed on the Mn/DOT Approved/Qualified Products Lists WEB site for Lighting:

<http://www.dot.state.mn.us/products/index.html>

The base plate is to be machine smooth cut both on the external edges and on the inner hole that provides access to the foundation shaft interior. During the fabricating process, the foundation type stamp is to be permanently and plainly marked on the top in a highly visible manner.

The foundation shaft is to be machine smooth-flame cut to length. Cableway openings shall be machine smooth-cut on both sides of the shaft 180 degrees apart. The cableway openings are to be parallel to the axis of the shaft +/- 1/2 degrees as measured along their full length. The minimum torque capacity indicated on the drawing for the entire foundation assembly shall take into account

“SAMPLE” ROADWAY LIGHTING SYSTEM SPECIAL PROVISIONS (April 08, 2010)
This “sample” set of Lighting System Special Provisions will require editing (add, delete, modify, update, etc.) prior to use on a specific project.

any diminished value that would be dictated by the cableway openings in the shaft. The appropriate edges/areas of the shaft are to be mechanically cleaned before the prescribed welding operations.

The Light Base, Design Steel E is acceptable for installation in the following soils:

SOIL DESCRIPTIONS	Probe Values in.-lbs. (Nim)	Typical Blow Count "N" per ASTM-D1586
Dense sands, and gravel; hard silts and clays.	500-600 (65-78)	35-50
Medium dense sandy gravel; very stiff to hard silts and clays.	400-500 (52-65)	24-40
Medium dense coarse sand and sandy gravel; stiff to very stiff silt and clays.	300-400 (39-52)	14-25
Loose to medium dense fine to coarse sand; firm to stiff clays and silts.	200-300 (26-39)	7-14

Q. Light Base, Design H

The Contractor shall furnish and install a concrete Light Base, Design H in accordance with Mn/DOT 2545.3F and Mn/DOT Standard Plate 8128, at the locations indicated in the Plan.

R. Light Base, Design P

The contractor shall furnish and install a Light Base, Design P in accordance with the detail shown in the Plan and the applicable provisions of Mn/DOT Standard Plate 8127.

Except in paved areas, and with approval by the Engineer, the Contractor may furnish and install, as an alternative to the concrete Light Base, Design P, a Light Base, Design Steel P. The Light Base, Design Steel P shall be as follows:

The Contractor shall furnish and install a Light Base, Design Steel P at the locations indicated in the Plan.

Mn/DOT approved Light Bases Design Steel P are listed on the Mn/DOT Approved/Qualified Products Lists WEB site for Lighting:

<http://www.dot.state.mn.us/products/index.html>

The base plate is to be machine smooth cut both on the external edges and on the inner hole that

“SAMPLE” ROADWAY LIGHTING SYSTEM SPECIAL PROVISIONS (April 08, 2010)
This “sample” set of Lighting System Special Provisions will require editing (add, delete, modify, update, etc.) prior to use on a specific project.

provides access to the foundation shaft interior. During the fabricating process, the foundation type stamp is to be permanently and plainly marked on the top in a highly visible manner.

The foundation shaft is to be machine smooth-flame cut to length. Cableway openings shall be machine smooth-cut on both sides of the shaft 180 degrees apart. The cableway openings are to be parallel to the axis of the shaft +/- 1/2 degrees as measured along their full length. The minimum torque capacity indicated on the drawing for the entire foundation assembly shall take into account any diminished value that would be dictated by the cableway openings in the shaft. The appropriate edges/areas of the shaft are to be mechanically cleaned before the prescribed welding operations.

The Light Base, Design Steel P is acceptable for installation in the following soils:

SOIL DESCRIPTIONS	Probe Values in.-lbs. (Nim)	Typical Blow Count "N" per ASTM-D1586
Dense sands, and gravel; hard silts and clays.	500-600 (65-78)	35-50
Medium dense sandy gravel; very stiff to hard silts and clays.	400-500 (52-65)	24-40
Medium dense coarse sand and sandy gravel; stiff to very stiff silt and clays.	300-400 (39-52)	14-25
Loose to medium dense fine to coarse sand; firm to stiff clays and silts.	200-300 (26-39)	7-14

S. Light Base, Design P Mod.

The contractor shall furnish and install a Light Base, Design P Mod. in accordance with the detail shown in the Plan and the applicable provisions of Mn/DOT Standard Plate 8127.

T. Light Base, Design Steel P

The Contractor shall furnish and install a Light Base, Design Steel P at the locations indicated in the Plan.

Mn/DOT approved Light Bases Design Steel P are listed on the Mn/DOT Approved/Qualified Products Lists WEB site for Lighting:

<http://www.dot.state.mn.us/products/index.html>

“SAMPLE” ROADWAY LIGHTING SYSTEM SPECIAL PROVISIONS (April 08, 2010)
This “sample” set of Lighting System Special Provisions will require editing (add, delete, modify, update, etc.) prior to use on a specific project.

The base plate is to be machine smooth cut both on the external edges and on the inner hole that provides access to the foundation shaft interior. During the fabricating process, the foundation type stamp is to be permanently and plainly marked on the top in a highly visible manner.

The foundation shaft is to be machine smooth-flame cut to length. Cableway openings shall be machine smooth-cut on both sides of the shaft 180 degrees apart. The cableway openings are to be parallel to the axis of the shaft +/- 1/2 degrees as measured along their full length. The minimum torque capacity indicated on the drawing for the entire foundation assembly shall take into account any diminished value that would be dictated by the cableway openings in the shaft. The appropriate edges/areas of the shaft are to be mechanically cleaned before the prescribed welding operations.

The Light Base, Design Steel P is acceptable for installation in the following soils:

SOIL DESCRIPTIONS	Probe Values in.-lbs. (N/m)	Typical Blow Count "N" per ASTM-D1586
Dense sands, and gravel; hard silts and clays.	500-600 (65-78)	35-50
Medium dense sandy gravel; very stiff to hard silts and clays.	400-500 (52-65)	24-40
Medium dense coarse sand and sandy gravel; stiff to very stiff silt and clays.	300-400 (39-52)	14-25
Loose to medium dense fine to coarse sand; firm to stiff clays and silts.	200-300 (26-39)	7-14

U. Light Base, Design R-40

The Contractor shall furnish and install a Light Base Design R-40 constructed in accordance with Mn/DOT 2545.3F and the detail shown in the Plan, in lieu of using a Light Base Design E when rock is encountered in the construction of the light base. A copper ground plate in accordance with the detail shall be provided with the Light Base, Design R-40 at the locations indicated in the Plan.

V. Equipment Pad A

The Contractor shall furnish and install a complete concrete pad in accordance with Mn/DOT Standard Plate No. 8105 and as indicated in the Plan. The equipment pad shall include the conduits and anchorage hardware within the concrete foundation, reinforcement bars if using the pre cast option, all wiring and hardware necessary, and all grounding and bonding materials.

“SAMPLE” ROADWAY LIGHTING SYSTEM SPECIAL PROVISIONS (April 08, 2010)
This “sample” set of Lighting System Special Provisions will require editing (add, delete, modify, update, etc.) prior to use on a specific project.

W. Equipment Pad B

The Contractor shall furnish and install a complete concrete pad in accordance with Mn/DOT Standard Plate No. 8106, at the locations indicated in the Plan. The equipment pad shall be constructed in accordance with Mn/DOT 2545.3F except the concrete shall be Mix No. 3A32.

The equipment pad mentioned will be used for mounting of a lighting service cabinet. The reinforcement bars for use in the foundation shall conform to the requirements of Mn/DOT 3301.

Equipment Pad B Modified

The Contractor shall furnish and install a complete concrete pad in accordance with Mn/DOT Standard Plate No. 8106 with the modifications shown in the Plan, at the locations indicated in the Plan. The equipment pad shall be constructed in accordance with Mn/DOT 2545.3F except the concrete shall be Mix No. 3A32.

The equipment pad mentioned will be used for mounting of a lighting service cabinet and meter socket.

The reinforcement bars for use in the foundation shall conform to the requirements of Mn/DOT 3301.

The mounting bracket assembly for the service equipment that is to be installed on the equipment pad shall be constructed in accordance with the detail in the Plans using 3/8" (9.5 mm) bolts anchored in the equipment pad.

X. Equipment Pad Signal Service

The Contractor shall furnish and install a complete concrete pad in accordance with the detail provided in the plan. The anchor rod pattern for the Department furnished cabinet is 483 mm (19 inches) by 356 mm (14 inches) rectangular, measured from the anchor rod centers. The anchor rods shall project above the concrete foundation to accommodate the 13 mm (1/2 inch) thick gasket.

Y. Service Cabinet, Secondary Type L1 (120/240 VAC)

The Contractor shall furnish and install a Service Cabinet, Secondary Type L1, for supplying power to an electric lighting system, on an equipment pad concrete foundation at the location indicated in the Plans.

Mn/DOT approved Service Cabinet's Secondary Type L1 are listed on the Mn/DOT Approved/Qualified Products Lists WEB site for Lighting:

<http://www.dot.state.mn.us/products/index.html>

“SAMPLE” ROADWAY LIGHTING SYSTEM SPECIAL PROVISIONS (April 08, 2010)
This “sample” set of Lighting System Special Provisions will require editing (add, delete, modify, update, etc.) prior to use on a specific project.

**Z. Service Cabinet, Secondary Type L1 (240/480 VAC)
With Cold Sequence Disconnect**

The Contractor shall furnish and install a Service Cabinet, Secondary Type L1 with a Cold Sequence Disconnect before meter socket, for supplying power to an electric lighting system, on an equipment pad concrete foundation at the location indicated in the Plans.
Mn/DOT approved Service Cabinet’s Secondary Type L1 with Cold Sequence Disconnect are listed on the Mn/DOT Approved/Qualified Products Lists WEB site for Lighting:

<http://www.dot.state.mn.us/products/index.html>

AA. Service Cabinet, Secondary Type L2 (120/240 VAC)

The Contractor shall furnish and install a Service Cabinet, Secondary Type L2, for supplying power to an electric lighting system, on an equipment pad concrete foundation at the location indicated in the Plans.

Mn/DOT approved Service Cabinet’s Secondary Type L2 are listed on the Mn/DOT Approved/Qualified Products Lists WEB site for Lighting:

<http://www.dot.state.mn.us/products/index.html>

**BB. Service Cabinet, Secondary Type L2 (240/480 VAC)
With Cold Sequence Disconnect**

The Contractor shall furnish and install a Service Cabinet, Secondary Type L2 with a Cold Sequence Disconnect before meter socket, for supplying power to an electric lighting system, on an equipment pad concrete foundation at the location indicated in the Plans. Mn/DOT approved Service Cabinet’s Secondary Type L2 with Cold Sequence Disconnect are listed on the Mn/DOT Approved/Qualified Products Lists WEB site for Lighting:

<http://www.dot.state.mn.us/products/index.html>

CC. Service Cabinet, Secondary Type A

The Contractor shall furnish and install a Mn/DOT approved Service Cabinet, Secondary Type A 240/480 VAC with meter socket, for supplying power to an electric lighting system, on a wood pole at the location indicated in the Plan. Meter will be furnished and installed by others.

Mn/DOT approved Service Cabinet’s Secondary Type A are listed on the Mn/DOT Approved/Qualified Products Lists WEB site for Lighting:

<http://www.dot.state.mn.us/products/index.html>

“SAMPLE” ROADWAY LIGHTING SYSTEM SPECIAL PROVISIONS (April 08, 2010)
This “sample” set of Lighting System Special Provisions will require editing (add, delete, modify, update, etc.) prior to use on a specific project.

The contractor shall furnish and install on the in place power pole, a meter socket, service cabinet, photocell and shield, conduit fittings, and all wiring and materials necessary for a complete service cabinet installation.

Service cabinet control shall be obtained by circuit breakers and a lighting contactor located in a single phase, 3 wire, 240/480 volt weatherproof pole mounted cabinet.

Mn/DOT approved Contactors are listed on the Mn/DOT Approved/Qualified Products Lists WEB site for Lighting:

<http://www.dot.state.mn.us/products/index.html>

DD. Service Cabinet, Secondary Type B

The Contractor shall furnish and install a Mn/DOT approved Service Cabinets, Secondary Type B for supplying power to an electric lighting system, on mounting bracket assemblies as indicated in the Plan. Meters will be furnished and installed by others.

Mn/DOT approved Service Cabinet’s Secondary Type B are listed on the Mn/DOT Approved/Qualified Products Lists WEB site for Lighting:

<http://www.dot.state.mn.us/products/index.html>

Conduits may enter the cabinet through the bottom of the cabinet utilizing appropriate weatherproof hubs, or through the side of the cabinet utilizing appropriate Type L condulets.

EE. Signal Service Cabinets With Battery Backup

The Contractor shall furnish and install a Signal Service Cabinet with Battery Backup for supplying power to an electric lighting system, on an equipment pad concrete foundation at the location indicated in the Plans. The service cabinet shall conform to the wiring requirements of Mn/DOT Standard Plate No. 8140 for a Type L2-D-120 lighting service cabinet, to the provisions in Mn/DOT 3850, to the details in the Plan, and shall include all internal and external wiring and materials required for a complete cabinet installation.

The Contractor shall install the rubber gasket sections between the bottom of each cabinet base and the concrete foundation. The Contractor shall leave one 13 mm (1/2 inch) gap in the gasket to ensure proper water drainage.

“SAMPLE” ROADWAY LIGHTING SYSTEM SPECIAL PROVISIONS (April 08, 2010)
This “sample” set of Lighting System Special Provisions will require editing (add, delete, modify, update, etc.) prior to use on a specific project.

Mn/DOT approved Signal Service Cabinets with Battery Back UP are listed on the Mn/DOT Approved/Qualified Products Lists WEB site for Signals:

<http://www.dot.state.mn.us/products/index.html>

Lighting Unit Options - Vertical Mounts types:

All Red text must be removed from the special provisions prior to the special provisions being submitted for project letting.

FF. Lighting Units, Type VMD-45 and VM-45 (Vertical Mount)

The Contractor shall furnish and install Lighting Units Type VMD-45 and VM-45 in accordance with the applicable provisions of Mn/DOT 2545.2R. A Lighting unit shall consist of a light standard, provisions for mounting of luminaire(s), vertical mount luminaire(s), lamp(s), and all miscellaneous equipment required for a complete lighting unit installation. Lighting units shall be fabricated from stainless steel or aluminum.

Lighting units fabricated from aluminum shall have a factory installed vibration dampener, 10 inch butt diameter, aluminum wall thickness of 0.188 inches, and luminaire tenons of 2-7/8 inches.

All vertical mount luminaires shall be mounted at a tilt of 45 degrees.

The Plan must indicate the following:

1. Lamp type
2. Operating Voltage
3. Wattage
4. Local Photo Cell control
5. Lens type

All Red text must be removed from the special provisions prior to the special provisions being submitted for project letting.

The Vertical Mount Luminaires shall be as indicated on the Plan.
The luminaires shall have a Type III medium semi-cutoff distribution per 1983 ANSI/IES standards, shall conform to the requirements of Mn/DOT 2545.2F and Mn/DOT 3810.

New Vertical Mount Luminaires shall be Mn/DOT approved Vertical Mount Luminaires listed on the Mn/DOT Approved/Qualified Products Lists WEB site for Lighting:

<http://www.dot.state.mn.us/products/index.html>

“SAMPLE” ROADWAY LIGHTING SYSTEM SPECIAL PROVISIONS (April 08, 2010)
This “sample” set of Lighting System Special Provisions will require editing (add, delete, modify, update, etc.) prior to use on a specific project.

GG. Lighting Unit, Type VMD-45

Lighting Unit, Type VMD-45 shall be stainless steel or aluminum, breakaway, and designed for 1 1/4 inch anchor bolts in a four bolt cluster as shown in Mn/DOT Standard Plate No. 8128. The light standard shall be in accordance with the detail shown in the Plan, shall have a 45 foot nominal luminaire mounting height, and shall have a luminaire mounting assembly for double luminaires.

All vertical mount luminaires shall be mounted at a tilt of 45 degrees.

The Plan must indicate the following:

1. Lamp type
2. Operating Voltage
3. Wattage
4. Local Photo Cell control
5. Lens type

All Red text must be removed from the special provisions prior to the special provisions being submitted for project letting.

The Vertical Mount Luminaires shall be as indicated on the Plan.

The luminaires shall have a Type III medium semi-cutoff distribution per 1983 ANSI/IES standards, shall conform to the requirements of Mn/DOT 2545.2F and Mn/DOT 3810.

New Vertical Mount Luminaires shall be Mn/DOT approved Vertical Mount Luminaires listed on the Mn/DOT Approved/Qualified Products Lists WEB site for Lighting:

<http://www.dot.state.mn.us/products/index.html>

HH. Lighting Unit, Type VM-45

Lighting Unit, Type VM-45 shall be stainless steel or aluminum, breakaway, and designed for 1 1/4 inch anchor bolts in a four bolt cluster as shown in Mn/DOT Standard Plate No. 8128. The light standard shall be in accordance with the detail shown in the Plan, shall have a 45 foot nominal luminaire mounting height, and shall have a luminaire mounting assembly for single luminaires.

All vertical mount luminaires shall be mounted at a tilt of 45 degrees.

The Plan must indicate the following:

1. Lamp type
2. Operating Voltage
3. Wattage
4. Local Photo Cell control
5. Lens type

All Red text must be removed from the special provisions prior to the special provisions being submitted for project letting.

“SAMPLE” ROADWAY LIGHTING SYSTEM SPECIAL PROVISIONS (April 08, 2010)
This “sample” set of Lighting System Special Provisions will require editing (add, delete, modify, update, etc.) prior to use on a specific project.

The Vertical Mount Luminaires shall be as indicated on the Plan.
The luminaires shall have a Type III medium semi-cutoff distribution per 1983 ANSI/IES standards, shall conform to the requirements of Mn/DOT 2545.2F and Mn/DOT 3810.

New Vertical Mount Luminaires shall be Mn/DOT approved Vertical Mount Luminaires listed on the Mn/DOT Approved/Qualified Products Lists WEB site for Lighting.

<http://www.dot.state.mn.us/products/index.html>

II. Lighting Unit, Type VMB-40 (Vertical Mount, Barrier Mounting)

The Contractor shall furnish and install a Lighting Unit, Type VMB-40. A Lighting Unit, Type VMB-40 shall consist of a light standard, provisions for mounting of a luminaire, vertical mount luminaire, lamp, and all miscellaneous equipment required for a complete lighting unit installation. The light standard shall be non-breakaway, designed for one inch anchor bolts in a six (6) bolt cluster as shown in the Plan, shall be high base style, shall be in accordance with the applicable provisions of Mn/DOT 2545.2R and with the details shown in the Plan.

Doors in the base of bridge or median mounted lighting units shall be at zero degrees to the mast arm and shall face the same direction.

All vertical mount luminaires shall be mounted at a tilt of 45 degrees.

The Plan must indicate the following:

1. Lamp type
2. Operating Voltage
3. Wattage
4. Local Photo Cell control
5. Lens type

All Red text must be removed from the special provisions prior to the special provisions being submitted for project letting.

The Vertical Mount Luminaires shall be as indicated on the Plan.
The luminaires shall have a Type III medium semi-cutoff distribution per 1983 ANSI/IES standards, shall conform to the requirements of Mn/DOT 2545.2F and Mn/DOT 3810.

New Vertical Mount Luminaires shall be Mn/DOT approved Vertical Mount Luminaires listed on the Mn/DOT Approved/Qualified Products Lists WEB site for Lighting.

<http://www.dot.state.mn.us/products/index.html>

“SAMPLE” ROADWAY LIGHTING SYSTEM SPECIAL PROVISIONS (April 08, 2010)
This “sample” set of Lighting System Special Provisions will require editing (add, delete, modify, update, etc.) prior to use on a specific project.

JJ. Lighting Units, Type VM-40 (Vertical Mount)

The Contractor shall furnish and install Lighting Units Type VM-40. A Lighting unit shall consist of a light standard, provisions for mounting of luminaire, vertical mount luminaire, lamp, and all miscellaneous equipment required for a complete lighting unit installation. Lighting units shall be breakaway, designed for one inch anchor bolts in a four bolt cluster as shown in Mn/DOT Standard Plate No. 8127, shall have a 40 foot nominal luminaire mounting height, shall have a luminaire mounting assembly for single luminaire, and shall be in accordance with the applicable provisions of Mn/DOT 2545.2R.

Lighting units fabricated from aluminum shall have a factory installed vibration dampener, 10 inch butt diameter, aluminum wall thickness of 0.188 inches, and luminaire tenons of 2-7/8 inches.

All vertical mount luminaires shall be mounted at a tilt of 45 degrees.

The Plan must indicate the following:

1. Lamp type
2. Operating Voltage
3. Wattage
4. Local Photo Cell control
5. Lens type

All Red text must be removed from the special provisions prior to the special provisions being submitted for project letting.

The Vertical Mount Luminaires shall be as indicated on the Plan.
The luminaires shall have a Type III medium semi-cutoff distribution per 1983 ANSI/IES standards, shall conform to the requirements of Mn/DOT 2545.2F and Mn/DOT 3810.

New Vertical Mount Luminaires shall be Mn/DOT approved Vertical Mount Luminaires listed on the Mn/DOT Approved/Qualified Products Lists WEB site for Lighting.

<http://www.dot.state.mn.us/products/index.html>

KK. Lighting Units, Type VMD-40 (Vertical Mount, Double)

The Contractor shall furnish and install Lighting Units Type VMD-40. A Lighting unit shall consist of a light standard, provisions for mounting of luminaire(s), vertical mount luminaire(s), lamp(s), and all miscellaneous equipment required for a complete lighting unit installation. Lighting units shall be designed for one inch anchor bolts in a four (4) bolt cluster as shown in Mn/DOT Standard Plate No. 8127, shall have a 40 foot nominal luminaire mounting height, shall have a luminaire mounting assembly for double luminaires, and shall be in accordance with the applicable provisions of Mn/DOT 2545.2R.

“SAMPLE” ROADWAY LIGHTING SYSTEM SPECIAL PROVISIONS (April 08, 2010)
This “sample” set of Lighting System Special Provisions will require editing (add, delete, modify, update, etc.) prior to use on a specific project.

Lighting units fabricated from aluminum shall have a factory installed vibration dampener, 10 inch butt diameter, aluminum wall thickness of 0.188 inches, and luminaire tenons of 2-7/8 inches.

All vertical mount luminaires shall be mounted at a tilt of 45 degrees.

The Plan must indicate the following:

1. Lamp type
2. Operating Voltage
3. Wattage
4. Local Photo Cell control
5. Lens type

All Red text must be removed from the special provisions prior to the special provisions being submitted for project letting.

The Vertical Mount Luminaires shall be as indicated on the Plan.

The luminaires shall have a Type III medium semi-cutoff distribution per 1983 ANSI/IES standards, shall conform to the requirements of Mn/DOT 2545.2F and Mn/DOT 3810.

New Vertical Mount Luminaires shall be Mn/DOT approved Vertical Mount Luminaires listed on the Mn/DOT Approved/Qualified Products Lists WEB site for Lighting:

<http://www.dot.state.mn.us/products/index.html>

Lighting Unit Options - Davit types:

All Red text must be removed from the special provisions prior to the special provisions being submitted for project letting.

LL. Lighting Unit, Type 9-30

The Contractor shall furnish and install a Lighting Unit, Type 9-30 in accordance with the applicable provisions of Mn/DOT 2545.2R. The light standard shall be non-breakaway, shall be designed for one inch anchor bolts in a four bolt cluster as shown in Mn/DOT Standard Plate No. 8127, shall be in accordance with the details shown in the Plan, shall have a 30 foot nominal luminaire mounting height, and shall have a nine (9) foot davit type mast arm.

Doors in the base of single mast arm units shall be at 180 degrees counterclockwise from the mast arm.

The Plan must indicate the following:

1. Lamp type
2. Operating Voltage
3. Wattage
4. Local Photo Cell control
5. Lens type

All Red text must be removed from the special provisions prior to the special provisions being submitted for project

27-SL

“SAMPLE” ROADWAY LIGHTING SYSTEM SPECIAL PROVISIONS (April 08, 2010)
This “sample” set of Lighting System Special Provisions will require editing (add, delete, modify, update, etc.) prior to use on a specific project.

The Cobra Head Luminaires shall be as indicated on the Plan.

The luminaires shall conform to the requirements of Mn/DOT 2545.2F, and Mn/DOT 3810.

New Cobra Head Luminaires shall be Mn/DOT approved Cobra Head Luminaires listed on the Mn/DOT Approved/Qualified Products Lists WEB site for Lighting:

<http://www.dot.state.mn.us/products/index.html>

MM. Lighting Unit, Type 9-40

The Contractor shall furnish and install a Lighting Unit, Type 9-40. Each Lighting Unit, Type 9-40 shall be in accordance with the applicable provisions of Mn/DOT 2545.2R. The light standard shall be breakaway, shall be designed for one inch anchor bolts in a four bolt cluster as shown in Mn/DOT Standard Plate No. 8127, shall be in accordance with the details shown in the Plan, shall have a 40 foot nominal luminaire mounting height, and shall have a nine (9) foot davit type mast arm.

Doors in the base of single mast arm units shall be at 180 degrees counterclockwise from the mast arm.

The Plan must indicate the following:

1. Lamp type
2. Operating Voltage
3. Wattage
4. Local Photo Cell control
5. Lens type

All Red text must be removed from the special provisions prior to the special provisions being submitted for project letting.

The Cobra Head Luminaires shall be as indicated on the Plan.

The luminaires shall conform to the requirements of Mn/DOT 2545.2F, and Mn/DOT 3810.

New Cobra Head Luminaires shall be Mn/DOT approved Cobra Head Luminaires listed on the Mn/DOT Approved/Qualified Products Lists WEB site for Lighting:

<http://www.dot.state.mn.us/products/index.html>

NN. Lighting Unit, Type 9-49

The Contractor shall furnish and install a Lighting Unit, Type 9-49. Each Lighting Unit, Type 9-49 shall be in accordance with the applicable provisions of Mn/DOT 2545.2R. The light standard shall be breakaway, designed for 1¼ inch anchor bolts in a four (4) bolt cluster as shown in Mn/DOT standard Plate No. 8128, shall be fabricated from stainless steel or aluminum, shall be in accordance

28-SL

“SAMPLE” ROADWAY LIGHTING SYSTEM SPECIAL PROVISIONS (April 08, 2010)
This “sample” set of Lighting System Special Provisions will require editing (add, delete, modify, update, etc.) prior to use on a specific project.

with the detail shown in the Plan, shall have a 49 foot nominal luminaire mounting height, and shall have a 9 foot davit type mast arm.

Light standards fabricated from stainless steel shall be high base type. Light standards fabricated from aluminum shall be transformer base type.

Doors in the base of single mast arm units shall be at 180 degrees counterclockwise from the mast arm.

The Plan must indicate the following:

1. Lamp type
2. Operating Voltage
3. Wattage
4. Local Photo Cell control
5. Lens type

All Red text must be removed from the special provisions prior to the special provisions being submitted for project letting.

The Cobra Head Luminaires shall be as indicated on the Plan.

The luminaires shall conform to the requirements of Mn/DOT 2545.2F, and Mn/DOT 3810.

New Cobra Head Luminaires shall be Mn/DOT approved Cobra Head Luminaires listed on the Mn/DOT Approved/Qualified Products Lists WEB site for Lighting.

<http://www.dot.state.mn.us/products/index.html>

OO. Lighting Unit, Type 12-40

The Contractor shall furnish and install a Lighting Unit, Type 12-40. Each lighting unit shall be in accordance with the applicable provisions of Mn/DOT 2545.2R. The light standard shall be breakaway, designed for one inch anchor bolts in a four bolt cluster as shown in Mn/DOT Standard Plate No. 8127, shall be in accordance with the detail shown in the Plan, shall have a 40 foot nominal luminaire mounting height, and shall have a twelve (12) foot davit type mast arm with a ten (10) foot radius.

Doors in the base of single mast arm units shall be at 180 degrees counterclockwise from the mast arm.

The Plan must indicate the following:

1. Lamp type
2. Operating Voltage
3. Wattage
4. Local Photo Cell control
5. Lens type

29-SL

“SAMPLE” ROADWAY LIGHTING SYSTEM SPECIAL PROVISIONS (April 08, 2010)
This “sample” set of Lighting System Special Provisions will require editing (add, delete, modify, update, etc.) prior to use on a specific project.

All Red text must be removed from the special provisions prior to the special provisions being submitted for project letting.

The Cobra Head Luminaires shall be as indicated on the Plan.

The luminaires shall conform to the requirements of Mn/DOT 2545.2F, and Mn/DOT 3810.

New Cobra Head Luminaires shall be Mn/DOT approved Cobra Head Luminaires listed on the Mn/DOT Approved/Qualified Products Lists WEB site for Lighting.

<http://www.dot.state.mn.us/products/index.html>

PP. Lighting Unit, Type 12-49

The Contractor shall furnish and install a Lighting Unit, Type 12-49. Each lighting unit shall be in accordance with the applicable provisions of Mn/DOT 2545.2R. The light standard shall be breakaway, designed for one and one quarter inch anchor bolts in a four bolt cluster as shown in Mn/DOT Standard Plate No. 8128, shall be in accordance with the detail shown in the Plan, shall have a 49 foot nominal luminaire mounting height, and shall have a twelve (12) foot davit type mast arm with a ten (10) foot radius.

Doors in the base of single mast arm units shall be at 180 degrees counterclockwise from the mast arm.

The Plan must indicate the following:

1. Lamp type
2. Operating Voltage
3. Wattage
4. Local Photo Cell control
5. Lens type

All Red text must be removed from the special provisions prior to the special provisions being submitted for project letting.

The Cobra Head Luminaires shall be as indicated on the Plan.

The luminaires shall conform to the requirements of Mn/DOT 2545.2F, and Mn/DOT 3810.

New Cobra Head Luminaires shall be Mn/DOT approved Cobra Head Luminaires listed on the Mn/DOT Approved/Qualified Products Lists WEB site for Lighting.

<http://www.dot.state.mn.us/products/index.html>

QQ. Lighting Unit, Type 6D-40

The Contractor shall furnish and install a Lighting Unit, Type 6D-40. Each Lighting Unit, Type 6D-40 shall be in accordance with 2545.2R. The light standard shall be breakaway, designed for one inch anchor bolts in a four bolt cluster as shown in Mn/DOT Standard Plate No. 8127B, shall be in

30-SL

“SAMPLE” ROADWAY LIGHTING SYSTEM SPECIAL PROVISIONS (April 08, 2010)
This “sample” set of Lighting System Special Provisions will require editing (add, delete, modify, update, etc.) prior to use on a specific project.

accordance with the details shown in the Plan, and shall have a 40 foot nominal luminaire mounting height.

Doors in the base of twin mast arm units shall be at 0 degrees with one of the mast arms and all doors shall face the same direction.

The Plan must indicate the following:

1. Lamp type
2. Operating Voltage
3. Wattage
4. Local Photo Cell control
5. Lens type

All Red text must be removed from the special provisions prior to the special provisions being submitted for project letting.

The Cobra Head Luminaires shall be as indicated on the Plan.

The luminaires shall conform to the requirements of Mn/DOT 2545.2F, and Mn/DOT 3810.

New Cobra Head Luminaires shall be Mn/DOT approved Cobra Head Luminaires listed on the Mn/DOT Approved/Qualified Products Lists WEB site for Lighting:

<http://www.dot.state.mn.us/products/index.html>

RR. Lighting Unit, Type 6B-40

The Contractor shall furnish and install a Lighting Unit, Type 6B-40. Each Lighting Unit, Type 6B-40 shall be in accordance with the applicable provisions of Mn/DOT 2545.2R. The light standard shall be non-breakaway, designed for one inch anchor bolts in a six (6) bolt cluster as shown in Mn/DOT Standard Plate No. 8322 with ground rods provided by others in each light base, shall be fabricated from galvanized steel in accordance with Mn/DOT 3394, shall be high base style, shall be in accordance with the detail shown in the Plan, shall have a 40 foot nominal luminaire mounting height, and shall have a six (6) foot davit type mast arm.

Light standards fabricated from stainless steel shall be high base type. Light standards fabricated from aluminum shall be transformer base type.

Doors in the base of bridge or median mounted lighting units shall be at zero degrees to the mast arm and shall face the same direction.

The Plan must indicate the following:

1. Lamp type
2. Operating Voltage
3. Wattage
4. Local Photo Cell control
5. Lens type

All Red text must be removed from the special provisions prior to the special provisions being submitted for project

31-SL

“SAMPLE” ROADWAY LIGHTING SYSTEM SPECIAL PROVISIONS (April 08, 2010)
This “sample” set of Lighting System Special Provisions will require editing (add, delete, modify, update, etc.) prior to use on a specific project.

The Cobra Head Luminaires shall be as indicated on the Plan.

The luminaires shall conform to the requirements of Mn/DOT 2545.2F, and Mn/DOT 3810.

New Cobra Head Luminaires shall be Mn/DOT approved Cobra Head Luminaires listed on the Mn/DOT Approved/Qualified Products Lists WEB site for Lighting:

<http://www.dot.state.mn.us/products/index.html>

SS. Lighting Unit, Type 6B-49

The Contractor shall furnish and install a Lighting Unit, Type 6BD-49. Each Lighting Unit, Type 6BD-49 shall be in accordance with the applicable provisions of 2545.2R. The lighting unit shall be galvanized steel in accordance with Mn/DOT 3394, non-breakaway, high base style, and shall be designed for one inch anchor bolts in a six (6) bolt cluster as shown in Mn/DOT Standard Plate No. 8322 with ground rods provided by others in each light base. The light standard shall be in accordance with the details shown in the Plans, shall have a 49 foot nominal luminaire mounting height, and six (6) foot twin davit type mast arms.

Doors in the base of bridge or median mounted lighting units shall be at zero degrees to the mast arm and shall face the same direction.

The Plan must indicate the following:

1. Lamp type
2. Operating Voltage
3. Wattage
4. Local Photo Cell control
5. Lens type

All Red text must be removed from the special provisions prior to the special provisions being submitted for project letting.

The Cobra Head Luminaires shall be as indicated on the Plan.

The luminaires shall conform to the requirements of Mn/DOT 2545.2F, and Mn/DOT 3810.

New Cobra Head Luminaires shall be Mn/DOT approved Cobra Head Luminaires listed on the Mn/DOT Approved/Qualified Products Lists WEB site for Lighting:

<http://www.dot.state.mn.us/products/index.html>

TT. Lighting Unit, Type 6BD-49

The Contractor shall furnish and install a Lighting Unit, Type 6BD-49. Each Lighting Unit, Type 6BD-49 shall be in accordance with the applicable provisions of Mn/DOT 2545.2R. The lighting unit shall be galvanized steel in accordance with Mn/DOT 3394, non-breakaway, high base style, and shall be designed for one inch anchor bolts in a six (6) bolt cluster as

32-SL

“SAMPLE” ROADWAY LIGHTING SYSTEM SPECIAL PROVISIONS (April 08, 2010)
This “sample” set of Lighting System Special Provisions will require editing (add, delete, modify, update, etc.) prior to use on a specific project.

shown in Mn/DOT Standard Plate No. 8322 with ground rods provided by others in each light base. The light standard shall be in accordance with the detail shown in the Plans, shall have a 49 foot nominal luminaire mounting height, and six (6) foot twin davit type mast arms.

Doors in the base of bridge or median mounted lighting units shall be at zero degrees to the mast arm and shall face the same direction.

The Plan must indicate the following:

1. Lamp type
2. Operating Voltage
3. Wattage
4. Local Photo Cell control
5. Lens type

All Red text must be removed from the special provisions prior to the special provisions being submitted for project letting.

The Cobra Head Luminaires shall be as indicated on the Plan.

The luminaires shall conform to the requirements of Mn/DOT 2545.2F, and Mn/DOT 3810.

New Cobra Head Luminaires shall be Mn/DOT approved Cobra Head Luminaires listed on the Mn/DOT Approved/Qualified Products Lists WEB site for Lighting.

<http://www.dot.state.mn.us/products/index.html>

Lighting Unit Options - Shoebox types:

All Red text must be removed from the special provisions prior to the special provisions being submitted for project letting.

UU. Lighting Unit, Type IX-30

The Contractor shall furnish and install a Lighting Unit, Type IX-30. Each Lighting Unit, Type IX-30 shall be in accordance with the applicable provisions of Mn/DOT 2545.2R. The light standard shall be non-breakaway, designed for one inch anchor bolts in a four bolt cluster as shown in the "LIGHT BASE DESIGN E MODIFIED STANDARD PLATE 8127" detail in the Plan, shall be fabricated from round tapered aluminum, shall have a factory finish color black, shall be in accordance with the detail shown in the Plans, shall have a 30 foot nominal luminaire mounting height, and shall have a one (1) foot beam type mast arm with a three (3) degree rise.

The Shoebox Luminaires shall be as indicated on the Plan.

The luminaires shall be a factory finish black color.

The luminaires shall conform to the requirements of Mn/DOT 2545.2F and the first and second paragraphs of Mn/DOT 3831.2D2a.

The Plan must indicate the following:

1. Lamp type
2. Operating Voltage

33-SL

“SAMPLE” ROADWAY LIGHTING SYSTEM SPECIAL PROVISIONS (April 08, 2010)
This “sample” set of Lighting System Special Provisions will require editing (add, delete, modify, update, etc.) prior to use on a specific project.

3. Wattage
 4. Local Photo Cell control
 5. Lens type
- All Red text must be removed from the special provisions prior to the special provisions being submitted for project letting.*

New Shoebox Luminaires shall be Mn/DOT approved Shoebox Luminaires listed on the Mn/DOT Approved/Qualified Products Lists WEB site for Lighting.

<http://www.dot.state.mn.us/products/index.html>

VV. Lighting Unit, Type 6X-30

The Contractor shall furnish and install a Lighting Unit, Type 6X-30. Each Lighting Unit, Type 6X-30 shall be in accordance with the applicable provisions of Mn/DOT 2545.2R. The light standard shall be non-breakaway, designed for one inch anchor bolts in a four bolt cluster as shown in Mn/DOT Standard Plate No. 8127, shall be fabricated from square tapered steel, shall have a factory finish color to match Federal Standard 595 No. 30051 (architectural brown), shall be in accordance with the detail shown in the Plans, shall have a 40 foot nominal luminaire mounting height, shall have a six (6) foot beam type mast arm with a three (3) degree rise, and shall conform to the requirements of Mn/DOT 3811. Light standards fabricated from steel shall be high base type.

The Shoebox Luminaires shall be as indicated on the Plan.

The Shoebox luminaires shall have a factory finish color to match Federal Standard 595 No. 30051 (architectural brown).

The Shoebox luminaires shall conform to the requirements of Mn/DOT 2545.2F and the first and second paragraphs of Mn/DOT 3811.

Doors in the base of single mast arm units shall be at 180 degrees to the mast arm.

The Plan must indicate the following:

1. Lamp type
2. Operating Voltage
3. Wattage
4. Local Photo Cell control
5. Lens type

All Red text must be removed from the special provisions prior to the special provisions being submitted for project letting.

New Shoebox Luminaires shall be Mn/DOT approved Shoebox Luminaires listed on the Mn/DOT Approved/Qualified Products Lists WEB site for Lighting.

<http://www.dot.state.mn.us/products/index.html>

34-SL

“SAMPLE” ROADWAY LIGHTING SYSTEM SPECIAL PROVISIONS (April 08, 2010)
This “sample” set of Lighting System Special Provisions will require editing (add, delete, modify, update, etc.) prior to use on a specific project.

WW. Lighting Unit, Type 6DX-30

The Contractor shall furnish and install a Lighting Unit, Type 6DX-30. Each Lighting Unit, Type 6DX-30 shall be in accordance with the applicable provisions of 2545.2R. The light standard shall be non-breakaway, shall be designed for one inch anchor bolts in a four bolt cluster as shown in Mn/DOT Standard Plate No. 8127, shall be fabricated from steel, shall have a factory finish color to match Federal Standard 595 No. 30051 (architectural brown), shall be in accordance with the attached detail, shall have a 30 foot nominal luminaire mounting height, and shall have twin 6 foot beam type mast arms with a three (3) degree rise.

Light standards fabricated from steel shall be high base type.

The Shoebox luminaires shall be as indicated on the Plan.

The Shoebox luminaires shall have a factory finish color to match Federal Standard 595 No. 30051 (architectural brown).

The Shoebox luminaires shall conform to the requirements of Mn/DOT 3810.

Doors in the base of twin mast arm units shall be at 0 degrees to one of the mast arms and all doors shall face the same direction.

The Plan must indicate the following:

1. Lamp type
2. Operating Voltage
3. Wattage
4. Local Photo Cell control
5. Lens type

All Red text must be removed from the special provisions prior to the special provisions being submitted for project letting.

New Shoebox Luminaires shall be Mn/DOT approved Shoebox Luminaires listed on the Mn/DOT Approved/Qualified Products Lists WEB site for Lighting:

<http://www.dot.state.mn.us/products/index.html>

SL-4.3 CONSTRUCTION REQUIREMENTS

A. Direct Buried Cable Installation

Plowing direct buried cable shall be done by means of a “vibratory plow with a “feed blade” that breaks the ground, places the cable to a predetermined depth, and closes the break in the ground. The vibratory plow must guide the cable into the bottom of the break, in such a manner, that little or no stress is placed on the cable during installation, ensuring no damage to the cable assembly. The cable must be fed through the plow blade chute and NOT pulled by the plow blade. Installation of underground cable by means of a vibratory plow that “pulls” the cable in place, is not acceptable.

35-SL

“SAMPLE” ROADWAY LIGHTING SYSTEM SPECIAL PROVISIONS (April 08, 2010)
This “sample” set of Lighting System Special Provisions will require editing (add, delete, modify, update, etc.) prior to use on a specific project.

The plowing method must be approved by the Engineer before installation of the cable.

B. Conduit Installation

Conduit shall be installed in accordance with Mn/DOT 2565.3D, except as follows:

Continuous Type HDPE Non-Metallic Conduit:

--- except for under existing pavements, underground Continuous Type HDPE Conduit shall be placed by trenching, stitching, plowing, or other method approved by the Engineer. Under existing pavements, Continuous Type HDPE Non-Metallic Conduit shall be placed as specified in 2565.3D2b.

Rigid Non-Metallic Conduit Joints:

--- the Contractor shall install appropriate sized long line couplings when installed under existing roadway surfaces

--- the applied PVC joint cement shall be allowed to set-up for six (6) hours before pulling the conduit through a directional bored channel.

Conduit in Handholes:

--- If the Contract requires the installation of a handhole within an armored cable run, a 2 inch N.M.C. stub out shall be installed for each cable entering the handhole. The 2 inch N.M.C. stub out shall be a minimum of 36 inches in length with non-metallic bell ends installed on each open end of the conduit stub out to prevent damage to the armored cable.

C. Handhole Installation

The Contractor shall install handholes in accordance with the provisions of Mn/DOT 2565.3E and as follows:

The required aggregate drain bed below the handhole shall be **compacted** before installation of the handhole.

All handholes shall be backfilled **after** the frame casting and cover have been installed onto the handhole.

D. Light Standard Installation

The Contractor shall install light standards in accordance with Mn/DOT 2545.3H and as follows:

Leveling nuts shall not be used when installing aluminum light standards on Light Bases, Design Steel (steel screw-in bases). In this case, the Contractor shall **ONLY USE SHIMS FOR LEVELING.**

36-SL

“SAMPLE” ROADWAY LIGHTING SYSTEM SPECIAL PROVISIONS (April 08, 2010)
This “sample” set of Lighting System Special Provisions will require editing (add, delete, modify, update, etc.) prior to use on a specific project.

Where leveling nuts are used, the leveling and top nuts shall both be securely tightened against the light standard base plate. Where shims are used the top nuts shall be securely tightened against the light standard base plate. The leveling nuts and top nuts shall be tightened as follows:

- the threads of the nuts shall be lubricated with a brush on anti seize lubricant and then the nuts shall be torqued to minimum 125 ft-lbs. required for 1 inch diameter anchorages.
- the threads of the nuts shall be lubricated with a brush on anti seize lubricant and then the nuts shall be torqued to minimum 240 ft-lbs. required for 1¼ inch diameter anchorages.

E. Light Standard or Light Unit Numbering and Service Cabinet Numbering

The Contractor shall number the light standards or light units (underpass luminaires, tunnel luminaires, special luminaires, etc.) and service cabinets in accordance with Mn/DOT 2545.3P.

Light standards shall be numbered with the complete feed point numbers and letters placed above the pole number regardless if complete numbering is shown in the Plan.

Light Standard Numbering shall consist of the entire feed point designation with the pole number placed below.

The Contractor shall also verify that the light standards and/or light units to be reinstalled are correctly numbered and if not the Contractor shall number the light standards and/or light units in accordance with Mn/DOT 2545.3P.

Mn/DOT approved Labels are listed on the Mn/DOT Approved/Qualified Products Lists WEB site for Lighting:

<http://www.dot.state.mn.us/products/index.html>

Letters and numbers shall have a minimum stroke width of 0.35 inches.

F. Wiring in Light Standard Concrete Bases

The Contractor shall install conduits in light standard concrete foundations in accordance with the provisions of Mn/DOT 2545.3G. Approximately 2 feet of slack cable shall be left in each light standard base.

“SAMPLE” ROADWAY LIGHTING SYSTEM SPECIAL PROVISIONS (April 08, 2010)
This “sample” set of Lighting System Special Provisions will require editing (add, delete, modify, update, etc.) prior to use on a specific project.

G. Light Base, Design Steel E & P

The Light Base, Design Steel _____ installation is to be per the manufacturers recommended procedures and accomplished by either a boom type or a bed mounted type power equipment. The maximum torque shall not exceed the torque shown in the detail since possible damage to the foundation could occur. In the case of extremely difficult soils that cause the torque capacity of the installation equipment or the mechanical limit of the foundation to be exceeded, the foundation may be installed at the discretion of the Engineer, in a predrilled hole **that is not larger than six (6) inches in diameter**. When foundation installations are in predrilled holes, minimum torque requirements shall be as recommended by the manufacturer. The installation torque may be measured by torque measuring devices currently available or by calibrating the hydraulic system of the installing equipment.

When steel bases are located in a cut section, the Contractor shall shape the backslope around the steel base with a maximum 25 mm (1 inch) base projection on the exposed side. When _____ steel bases are located in a fill section, the Contractor shall mound the foundation excavation _____ to maintain a 25 mm (1 inch) maximum base projection on the exposed side. The Light Base, Design Steel shall be installed with the cableway entrances 90 degrees from the roadway.

H. Service Equipment

The Contractor shall furnish and install service equipment that consists of a meter socket, required mounting brackets, conduit fittings, required wiring, and other items incidental to a complete meter socket installation. The meter socket shall be in accordance with Mn/DOT 3837. Meter will be furnished and installed by others.

The meter socket shall be suitable for single phase 3-wire 240/480 volt AC, shall contain a positive bypass mechanism, shall have lugs that will allow the power conductors to be stripped and laid into the lugs without being cut, and shall be approved by the power company.

I. Blank

J. Electrical Service

Electrical service shall cover the exact costs charged by the power company plus 10% to provide power to the service panel(s). It is the Contractors responsibility to verify the actual work to be done and all the associated costs. The Contractor shall submit, to the Engineer, a copy of the power company invoice prior to final acceptance of the project, or when requested by the Engineer.

The contractor shall fill out the following electric service information form for lighting systems.

The Contractor shall provide, to the Engineer prior to final acceptance of the project, four (4) copies of the electric service information form for lighting systems and the copies shall be distributed, by the Engineer, as follows:

“SAMPLE” ROADWAY LIGHTING SYSTEM SPECIAL PROVISIONS (April 08, 2010)
This “sample” set of Lighting System Special Provisions will require editing (add, delete, modify, update, etc.) prior to use on a specific project.

1. Mn/DOT Central Electrical Services Unit (Non-Metro Projects Only), or
2. Mn/DOT Metro Electrical Services Unit (Metro Projects Only).
3. Mn/DOT Traffic Electrical Systems Engineer.
4. City of _____ or County of _____.

The Contractor furnished "electrical service information form for lighting systems" shall be considered incidental work.

(The following form should be left on its own page so it can be removed from the special provisions and used by the contractor). See the next page of this document
All Red text must be removed from the special provisions prior to the special provisions being submitted for project letting.

“SAMPLE” ROADWAY LIGHTING SYSTEM SPECIAL PROVISIONS (April 08, 2010)
This “sample” set of Lighting System Special Provisions will require editing (add, delete, modify, update, etc.) prior to use on a specific project.

Electric Service Information Form For Lighting Systems

Project Number: _____

Contractor: _____

Date: _____

System	Mn/DOT Feed Point Number	Meter Address	Electric Utility Transformer Size In KVA	Length of conductors in feet from transformer connection to meter socket connection.		
				L1 =	L2 =	Neutral =
				L1 =	L2 =	Neutral =
				L1 =	L2 =	Neutral =
				L1 =	L2 =	Neutral =
				L1 =	L2 =	Neutral =
				L1 =	L2 =	Neutral =
				L1 =	L2 =	Neutral =
				L1 =	L2 =	Neutral =
				L1 =	L2 =	Neutral =

“SAMPLE” ROADWAY LIGHTING SYSTEM SPECIAL PROVISIONS (April 08, 2010)
This “sample” set of Lighting System Special Provisions will require editing (add, delete, modify, update, etc.) prior to use on a specific project.

K. Relocate Lighting Unit

The Contractor shall relocate the complete lighting unit (pole, mast arm, luminaire, lamp, transformer base and base anchorage), salvaged from the project, at the location shown in the Plan and/or as designated by the Engineer. The Contractor shall provide the threaded studs or hex head bolts for mounting the lighting units to the light base.

All components of the lighting unit shall be installed in a workable first class condition and shall include all miscellaneous hardware required for a complete lighting unit relocation.

L. Install Salvaged Lighting Service Cabinet

The Contractor shall install the lighting service cabinet salvaged from the project, on equipment pad B and at the location shown in the Plan and/or as designated by the Engineer. The Contractor shall be required to coordinate with the power company to reconnect power to the service cabinet.

All components of the service cabinet shall be installed in a workable first class condition and shall include all miscellaneous hardware required for a complete service cabinet installation.

M. Painting

Painting shall be in accordance with the provisions of Mn/DOT 2545.3M, except that steel lighting service cabinet finish coats, unless specified as otherwise, shall have two field coats of dark green conforming to Mn/DOT 3532.

N. Anti-Seize Lubricant

Threaded portions of all anchor rods above concrete foundations and steel bases shall be coated with a brush-on anti-seize lubricant before installation of lighting units, lighting service cabinets, or other type cabinets on anchor rods.

The Contractor shall also apply brush-on anti-seize lubricant to the access door nut and bolt of each lighting unit.

O. Blank

P. Luminaires & Lamp Labeling

Luminaires and Lamps shall be marked according to 3810.2A. The term permanent marker shall be modified as follows “black oil based paint marker”

(The following Section should be included when you want to use Extended Life Lamps)
All Red text must be removed from the special provisions prior to the special provisions being submitted for project

41-SL

“SAMPLE” ROADWAY LIGHTING SYSTEM SPECIAL PROVISIONS (April 08, 2010)
This “sample” set of Lighting System Special Provisions will require editing (add, delete, modify, update, etc.) prior to use on a specific project.

letting.

Q. Luminaire Lamp Igniter Module

During installation of the luminaire the plug in lamp igniter module must be removed from the 3 position socket. The igniter module shall be securely tie wrapped to the inside of the luminaire housing. This work shall be incidental.

R. Bonding and Grounding

All bonding and grounding shall be in accordance with the provisions of Mn/DOT 2545.3R and as follows:

1. All required ground rod electrodes shall be NRTL Listed.
2. The Bronze armor for each cable assembly in each pole base shall be drilled with a 5/16” drill and placed on the grounding stud provided in the pole base.
3. The Re-usable screw type active clamping ground lug with a tang shall be placed on top of the armor.
4. Bonding of the #6 AWG solid bare grounding conductor to the pole base 5/16” grounding stud shall be accomplished by use of a UL listed Re-usable screw type active clamping ground lug with a tang that connects to the 5/16” pole base grounding stud.
5. The entire assembly (bronze armor and the grounding lug) shall be tightened to from an electrically bonded and grounded connection.
6. Shall apply an oxide inhibiting agent to the connection after final connection and assembly.

S. Oxide Inhibitor

The Contractor shall apply an oxide inhibiting agent to all No. 6 grounding connections after assembly and final connection.

SL-4.4 MEASUREMENTS AND PAYMENTS

A. Install Lighting Units

Installing salvaged lighting units at the locations indicated in the Plan will each be measured as an integral unit complete in place and will be paid for separately under pay Item No. 2545.602 (INSTALL LIGHTING UNIT) at the Contract price per EACH, which price shall be compensation in full.

THIS ITEM INCLUDES THE FOLLOWING:

1. Installing three (3) salvaged lighting units as specified including lamps, luminaire, ballast, pole

42-SL

“SAMPLE” ROADWAY LIGHTING SYSTEM SPECIAL PROVISIONS (April 08, 2010)
This “sample” set of Lighting System Special Provisions will require editing (add, delete, modify, update, etc.) prior to use on a specific project.

base, pole and bracket, inline fuse, wiring between pole base and fixtures, numbering of the light standard, and all miscellaneous items required for a complete installation.

2. Bonding and grounding materials and connections.
3. Traffic Control

B. Service Equipment

Furnishing, installing, and making operational service equipment as specified herein at the location indicated in the Plans will be measured as an integral unit complete in place and operating and will be paid for under pay Item No. 2545.602 (SERVICE EQUIPMENT) at the Contract price per EACH, which price shall be compensation in full.

THIS ITEM INCLUDES THE FOLLOWING:

1. Meter socket and mounting brackets.
2. All conduit and power conductors on wood pole.
3. Wiring connections.
4. Ground rod electrode.
5. Bonding and grounding materials and connections.
6. Other items incidental to a complete meter socket installation.

C. Electrical Service

Electrical Service will each be measured by the total invoice amount paid plus 10%, as specified herein, to the power company and paid for separately at the Contract Adjusted Unit Price per EACH under pay Item 2545.602 (ELECTRICAL SERVICE) shall be compensation in full for electrical service as specified. Payment will be made at the Contract Adjusted Unit Price as listed below.

Contract Adjusted Unit Price = Bid Amount – ((Bid Amount – (Invoice Cost For Each Service X 1.1))

D. Relocate Lighting Unit

Relocating lighting unit (includes pole, mast arm, luminaire, lamp, transformer base, and base anchorage) as specified herein, at the location indicated in the Plan will be measured as an integral unit complete in place and will be paid for under pay Item No. 2545.602 (RELOCATE LIGHTING UNIT) at the Contract price per EACH, which price shall be compensation in full.

E. Underground Cable Splice

Furnishing and installing an underground cable splice as specified herein, at the location indicated in the Plan, will be measured as an integral unit complete in place and will be paid for under pay Item

43-SL

“SAMPLE” ROADWAY LIGHTING SYSTEM SPECIAL PROVISIONS (April 08, 2010)
This “sample” set of Lighting System Special Provisions will require editing (add, delete, modify, update, etc.) prior to use on a specific project.

No. 2545.602 (UNDERGROUND CABLE SPLICE) at the Contract price per EACH, which price shall be compensation in full.

F. Install Service Cabinet

Installing a Lighting Service Cabinet, Type _____ (including all required mounting hardware) as specified herein, at the location indicated in the Plan, will each be measured as an integral unit complete in place and will be paid for separately under pay Item No. 2545.602 (INSTALL SERVICE CABINET) at the Contract price per EACH, which price shall be compensation in full.

THIS ITEM INCLUDES THE FOLLOWING:

1. Installing service cabinet on concrete foundation.
2. All required mounting hardware.
3. Making all field wiring connections.
4. Number the service cabinet with decals (as specified in Mn/DOT 2545) and in accordance with the numbering indicated in the Contract.
5. Label branch circuit breakers as specified in Mn/DOT 3850.
6. Sealing around cabinet base.
7. Painting service cabinet (if required).
8. Bonding and grounding materials and connections.
9. Miscellaneous items required for complete installation.

44-SL

“SAMPLE” ROADWAY LIGHTING SYSTEM SPECIAL PROVISIONS (April 08, 2010)
This “sample” set of Lighting System Special Provisions will require editing (add, delete, modify, update, etc.) prior to use on a specific project.

Contractor Certification of Disposal

Project No.: _____ Location: _____

We, _____, hereby certify that the lighting service cabinets and other painted
(Contractor Name)

materials removed were removed, transported, and disposed of in accordance with all requirements of the Minnesota Pollution Control Agency (MPCA) and the Occupational Safety & Health Administration (OSHA) for the removal, transporting, and disposal of hazardous waste.

SIGNATURE

DATE

After signed and dated, the Contractor shall submit this form to the Mn/DOT project Engineer.
The Contractor shall also submit to the Engineer a copy of the “Tipping Receipt” that the Contractor receives from the scrap yard or recycler.

Appendix F - Miscellaneous Information

CHARACTERISTICS OF WIRE

AWG	RESISTANCE COPPER Ω/1000 FT	AMPACITY THW	RESISTANCE ALUMINUM	NOTE: LOAD WIRES TO NO MORE THAN 80% OF FIGURES IN TABLE IF MORE THAN 3 CONDUCTORS IN A CROUP, USE THE FOLLOWING %AGES OF FIGURES IN TABLE: 4-6 80% 7-24 70% 25-42 60% 43 & UP 50%
18	6.51	-	10.7	
16	4.1	-	6.72	
14	2.57	20	4.22	
12	1.62	25	2.66	
10	1.018	35	1.67	
8	0.6404	50	1.05	
6	0.41	65	0.674	
4	0.259	85	0.424	
3	0.205	100	0.336	
2	0.162	115	0.266	
1	0.129	130	0.211	
0	0.102	150	0.168	
00	0.0811	175	0.133	
000	0.0642	200	0.105	

RIGID STEEL CONDUIT

POWER CABLE

SIZE (INCHES)	AREA (SQ. IN.)	40% (FILL)	CABLE SIZE	O.D (INCHES)	AREA (SQ. IN)			
					1	2	3	4
¾"	0.533	0.2132	#1/0	0.5490	0.2367	0.4734	0.7102	0.9469
1"	0.8957	0.3583	#2	0.4330	0.1473	0.2945	0.4418	0.4347
1 ¼"	1.4957	0.5983	#4	0.3720	0.1087	0.2174	0.3216	0.4347
1 ½"	2.0358	0.8143	#6	0.3230	0.0819	0.1639	0.2458	0.3278
2"	3.3555	1.3422	#6 BARE	0.1800	0.0254	0.0509	0.0763	0.1018
2 ½"	4.7878	1.9151	#8	0.2800	0.0616	0.1232	0.1847	0.2463
3"	7.3928	2.9571	#10	0.2200	0.0380	0.0760	0.1140	0.1521
3 ½"	9.8869	3.9548	3/C #4	1.0000	0.7854	1.5708	2.3562	3.1416
4"	12.7304	5.0922	(armoured)					
4 ½"	15.9468	6.3787	4/C #4	1.3333	1.3963	2.7926	4.1889	5.5852
5"	20.006	8.0024	(armoured)					

WIRE SIZE CALCULATION

$$R_{MAX} = \frac{\text{line voltage} * \text{allowed percentage drop}}{\text{current} * \text{distance factor}} \quad \text{(RMAX GIVEN IN } \Omega/1000 \text{ FT)}$$

DIMENSIONS OF CONDUIT									
Trade Size Inches	RSC			Schedule 40-Heavy Wall NMC			Schedule 80-PVC Heavy Wall NMC		
	Inside Diameter Inches	Area Sq. In.	40% Area Sq. In.	Inside Diameter Inches	Area Sq. In.	40% Area Sq. In.	Inside Diameter Inches	Area Sq. In.	40% Area Sq. In.
1/2	0.622	0.304	0.121	0.622	0.304	0.121	0.546	0.234	0.094
3/4	0.824	0.533	0.213	0.824	0.533	0.213	0.742	0.432	0.173
1	1.049	0.864	0.346	1.049	0.864	0.346	0.957	0.719	0.288
1-1/2	1.610	2.035	0.814	1.610	2.035	0.814	1.500	1.766	0.707
2	2.067	3.354	1.342	2.067	3.354	1.342	1.939	2.951	1.181
2-1/2	2.469	4.785	1.914	2.469	4.785	1.914	2.323	4.236	1.694
3	3.068	7.389	2.956	3.068	7.389	2.956	2.900	6.602	2.641
4	4.026	12.724	5.090	4.026	12.724	5.090	3.826	11.491	4.596
5	5.047	19.996	7.998	5.047	19.996	7.998	4.813	18.185	7.274

ELECTRICAL CONDUCTORS (THW*)				
CABLE	DIAMETER (Inches)	AREA (Sq. In.)		
		1 Cable	2 Cables	3 Cables
No. 3/0	0.67	0.352	0.705	1.057
No. 2/0	0.59	0.273	0.547	0.820
No. 1/0	0.55	0.237	0.475	0.712
No. 1	0.51	0.204	0.408	0.613
No. 2	0.43	0.145	0.290	0.435
No. 4	0.35	0.096	0.192	0.288
No. 6	0.30	0.071	0.141	0.212
No. 6 Bare	0.16	0.020	0.040	0.060
No. 8	0.28	0.062	0.123	0.185
No. 10	0.20	0.031	0.063	0.094

ELECTRICAL CABLE (PVC JACKET)				
CABLE	DIAMETER (Inches)	AREA (Sq. In.)		
		1 Cable	2 Cables	3 Cables
2/C No. 14	0.36	0.099	0.198	0.297
3/C No. 20	0.30	0.071	0.141	0.212
3/C No. 12	0.45	0.159	0.318	0.477
5/C No. 12	0.53	0.221	0.441	0.662
12/C No. 12	0.79	0.490	0.980	1.470
6 Pr No. 19	0.55	0.237	0.475	0.712

*Table may be used for THWN, THHN, or XHHW (XLPE) which are smaller in diameter.

If using NMC, use 35% fill.

photometric data

HPS LUMINAIRE SERIES 153/154

The following data is based on a Series 153 unit with a 1000 lumen High Pressure Sodium lamp producing I.E.S. Type II, Medium Cutoff. Refer to Chart I for actual lumen ratings, multiply all footcandle and lumen values shown by factor listed in Chart I. Mounting height is 40 feet, refer to Chart II for mounting height conversion factors. I.E.S. Type III data available on request.

CHART I

Lamp	Lumen Rating	Factor
310W HPS	37,000	37.0
250W HPS	27,500	27.5
200W HPS	22,000	22.0

CHART II

Mtg. Ht.	30'	35'	40'	45'	50'
Factor	1.78	1.31	1.00	.79	.64

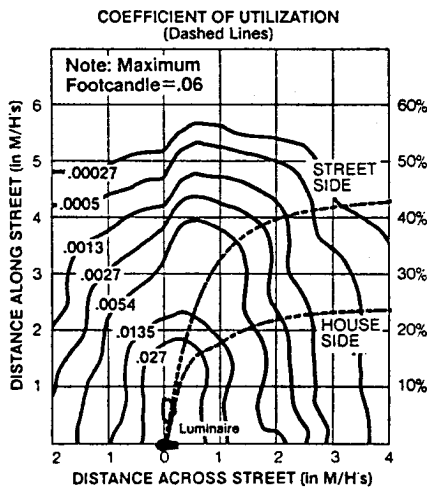

FLUX VALUES

	Lumens	Percent of Lamp
Downward Street Side	453	45.3
Downward House Side	256	25.6
Total Downward	709	70.9
Total Flux	709	70.9%

Typical configuration using two HPS Luminaires at 180°.

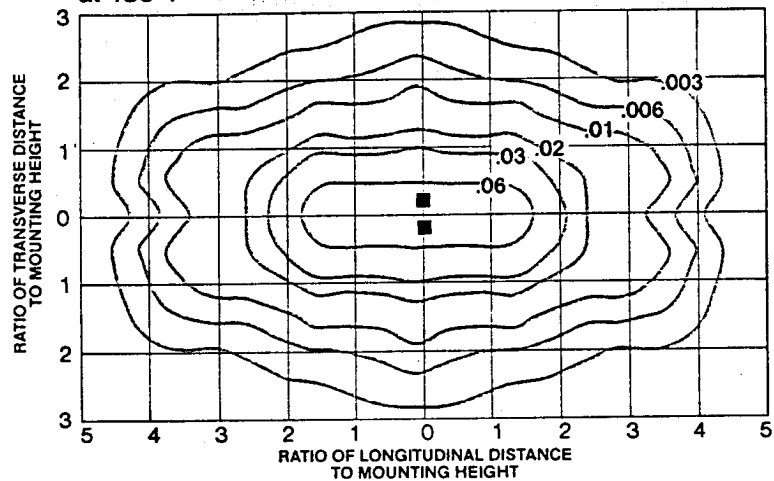

Isofootcandle Lines of Horizontal Illumination—2 Units

Typical configuration using four HPS Luminaires at 90°.

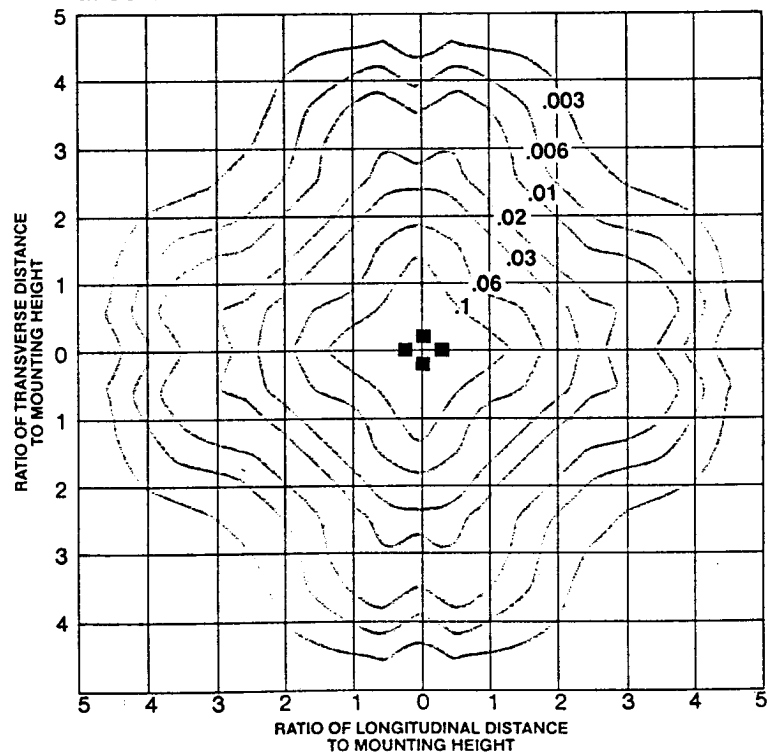

Isofootcandle Lines of Horizontal Illumination—4 Units

photometric data

HPS CUTOFF LUMINAIRE SERIES 153/154

The following data is based on a 1000 lumen High Pressure Sodium lamp. Refer to Chart I for actual lumen ratings, multiply all footcandle and lumen values shown by factor listed in chart. Mounting height is 30 feet, refer to Chart II for conversion factors.

CHART I

HPS Lamp	Lumen Rating	Factor
200W	22,000	22
250W	27,500	27.5
250W/S	30,000	30
310W	37,000	37
400W	50,000	50

CHART II

Mounting Height	25	28	30	32	35	40
Factor	1.44	1.15	1.00	.88	.74	.56

TYPICAL AREA LIGHTING APPLICATIONS

Initial footcandles for a 240 ft. square area installation using 16—250 watt HPS Cutoff luminaires producing I.E.S. Type III, medium cutoff, mounted in clusters of four 150 ft. apart with a 30 ft. mounting height.

240'	1.3	2.1	3.1	3.3	3.2	2.1	1.4	1.2	1.6	1.2	1.4	2.1	3.2	3.3	3.1	2.1	1.3
225'	2.1	3.7	6.3	7.7	6.3	3.8	2.2	1.6	2.0	1.6	2.2	3.8	6.3	7.7	6.3	3.7	2.1
210'	3.1	6.3	9.0	11.5	9.0	6.3	3.3	2.1	2.0	2.1	3.3	6.3	9.0	11.5	9.0	6.3	3.1
195'	3.3	7.7	11.5	14.6	11.5	7.7	3.4	1.5	1.4	1.5	3.4	7.7	11.5	14.6	11.5	7.7	3.3
180'	3.2	6.3	9.0	11.5	9.1	6.4	3.3	2.1	2.0	2.1	3.3	6.4	9.1	11.5	9.0	6.3	3.2
165'	2.1	3.8	6.4	7.7	6.4	3.8	2.3	1.7	2.0	1.7	2.3	3.8	6.4	7.7	6.4	3.8	2.1
150'	1.4	2.2	3.3	3.4	3.3	2.3	1.5	1.4	1.7	1.4	1.5	2.3	3.3	3.4	3.3	2.2	1.4
135'	1.2	1.6	2.1	1.5	2.1	1.7	1.4	1.3	1.5	1.3	1.4	1.7	2.1	1.5	2.1	1.6	1.2
120'	1.6	2.0	2.0	1.4	2.0	2.0	1.7	1.5	1.5	1.5	1.7	2.0	2.0	1.4	2.0	2.0	1.6
105'	1.2	1.6	2.1	1.5	2.1	1.7	1.4	1.3	1.5	1.3	1.4	1.7	2.1	1.5	2.1	1.6	1.2
90'	1.4	2.2	3.3	3.4	3.3	2.3	1.5	1.4	1.7	1.4	1.5	2.3	3.3	3.4	3.3	2.2	1.4
75'	2.1	3.8	6.4	7.7	6.4	3.8	2.3	1.7	2.0	1.7	2.3	3.8	6.4	7.7	6.4	3.8	2.1
60'	3.2	6.3	9.0	11.5	9.1	6.4	3.3	2.1	2.0	2.1	3.3	6.4	9.1	11.5	9.0	6.3	3.2
45'	3.3	7.7	11.5	14.6	11.5	7.7	3.4	1.5	1.4	1.5	3.4	7.7	11.5	14.6	11.5	7.7	3.3
30'	3.1	6.3	9.0	11.5	9.0	6.3	3.3	2.1	2.0	2.1	3.3	6.3	9.0	11.5	9.0	6.3	3.1
15'	2.1	3.7	6.3	7.7	6.3	3.8	2.2	1.6	2.0	1.6	2.2	3.8	6.3	7.7	6.3	3.7	2.1
0'	1.3	2.1	3.1	3.3	3.2	2.1	1.4	1.2	1.6	1.2	1.4	2.1	3.2	3.3	3.1	2.1	1.3

0' 15' 30' 45' 60' 75' 90' 105' 120' 135' 150' 165' 180' 195' 210' 225' 240'
 Max.=14.57 Avg.=4.06 Min.=1.18 Avg./Min.=3.4:1 Max./Min.=12.4:1

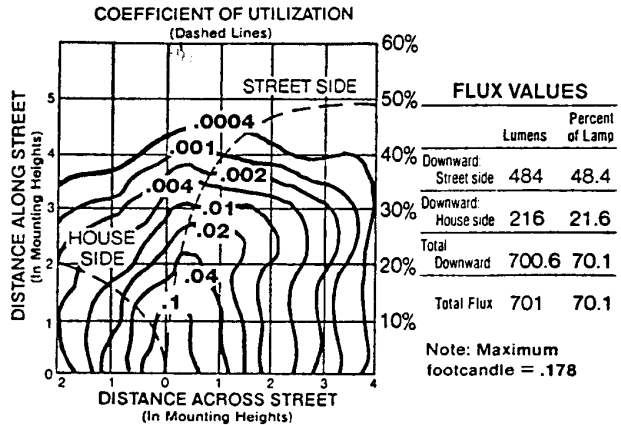

Data is based on a High Pressure Sodium lamp producing an I.E.S. Type III Medium cutoff.

Typical configuration using four HPS cutoff luminaires at 90°, producing I.E.S. Type III, medium cutoff.

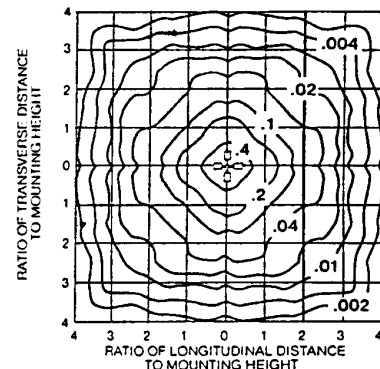

Isofootcandle Lines of Horizontal Illumination—4 Units

Typical configuration using two HPS cutoff luminaires at 180°, producing I.E.S. Type III, medium cutoff.

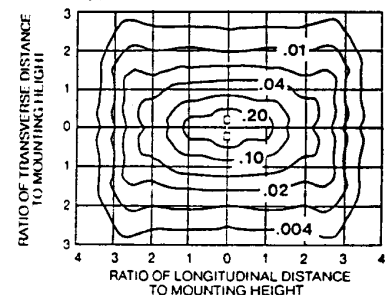

Isofootcandle Lines of Horizontal Illumination—2 Units

UTILIZATION CURVE

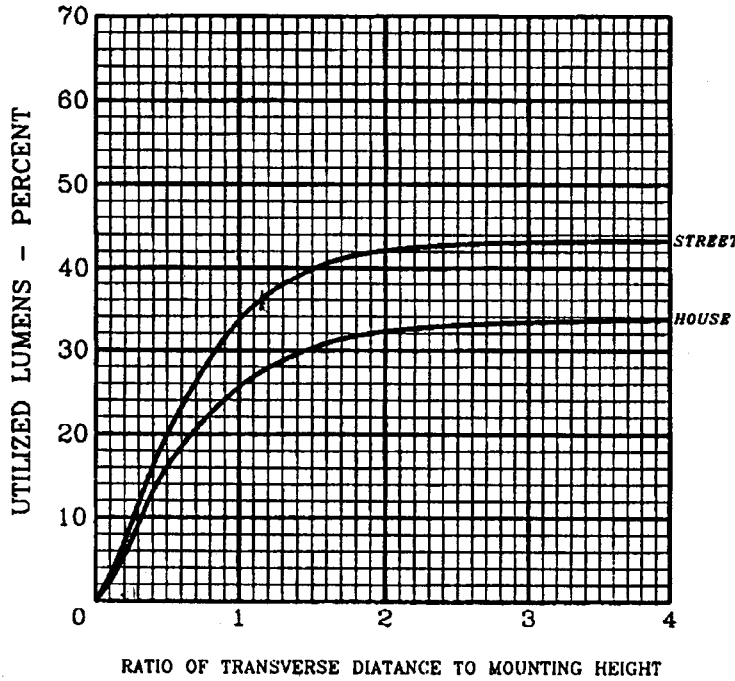

ISOFOOTCANDLE CURVES

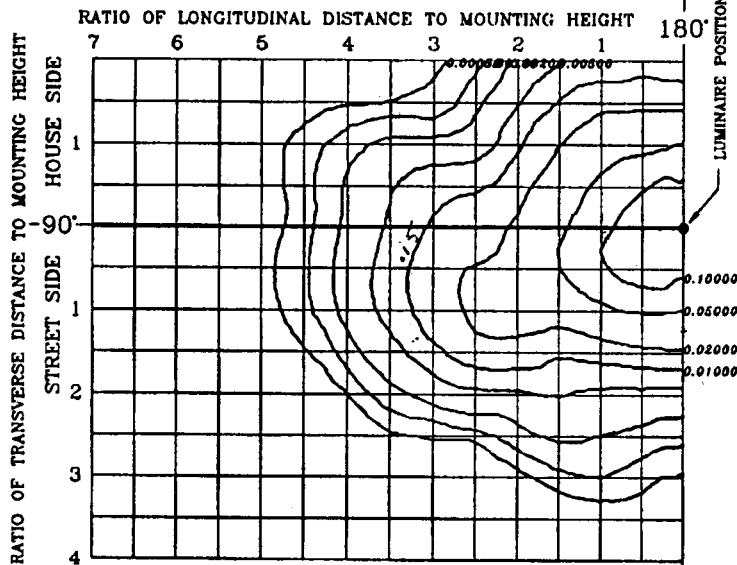

PER 1000 LAMP LUMENS

NOTE: 1 FOOTCANDLE = 10.76 LUX

MOUNTING HEIGHT CORRECTION FACTORS FOR OTHER THAN 30 FEET.

USE TABLE BELOW OR FACTOR = $\frac{900}{(\text{ACTUAL MH})^2}$

MOUNTING HEIGHT- FEET	20	25	30	35	40	45	50
FACTOR	2.25	1.44	1	.73	.56	.44	.36

GE Lighting Systems
Hendersonville, NC 28739

PHOTOMETRIC DATA PER 1000 LAMP LUMENS

*THIS DATA SHOWS REPRESENTATIVE
PRODUCT PERFORMANCE*

LUMINAIRE

M400 CUTOFF
REFRACTOR: 639 SAG GLASS
REFLECTOR: 431561-01
SOCKET: 1F
SOCKET BRACKET 420607-02

LAMP

400 WATT HPS
LU400
S51

ANSI/IES TYPE 1972 CIE TYPE

M-C-II CUTOFF

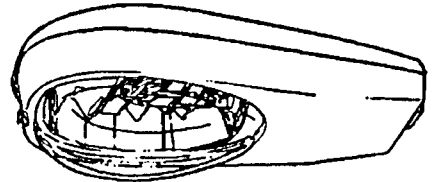

GENERAL INFORMATION

TEST DISTANCE **7 METERS**
MAX CANDELA **496**
MAX CONE **70**
MAX VERTICAL PLANE **67.5**
MAX CANDELA AT 90° **2**
MAX CANDELA AT 80° **16**
NADIR FOOTCANDLES **.16**
NADIR CANDELA **148**

MULTIPLY ALL LUMEN, CANDELA, AND
FOOTCANDLE VALUES BY THIS RATIO

$$\text{RATIO} = \frac{\text{ACTUAL LAMP LUMENS}}{1000}$$

PHOTOMETRIC TEST IN ACCORDANCE
WITH IES GUIDE

LIGHT FLUX VALUES

	LUMENS	PERCENT OF LAMP
DOWNWARD STREET SIDE	437	44
UPWARD STREET SIDE	0	0
DOWNWARD HOUSE SIDE	341	34
UPWARD HOUSE SIDE	0	0
TOTAL	778	78

TEST NUMBER **96121307**

TESTED BY <i>Jerry Bastin JB</i>	APPROVED BY <i>Jim Havard JH</i>	DATE 03-23-98	DRAWING NO. 35-450864	SHEET 1	REVISION 00
-------------------------------------	-------------------------------------	-------------------------	---------------------------------	-------------------	-----------------------

General Electric Lamp Data

High Pressure Sodium

<u>Type</u>	<u>Lumens</u>
70 watt	5,800
100 watt	9,500
150 watt	16,000
200 watt	22,000
250 watt	27,500
310 watt	37,000
400 watt	50,000
1000 watt	140,000

Metal Halide

<u>Type</u>	<u>Lumens</u>
100 watt	8,500
175 watt	12,000
250 watt	19,500
400 watt	32,000
1000 watt	107,800

Mercury

<u>Type</u>	<u>Lumens</u>
100 watt	3,650
175 watt	7,570
250 watt	10,700
400 watt	20,000
1000 watt	54,000

Appendix G - Index

A

Agreements	5-1, 5-2
Appendix	2-12

B

Bridges	1-4
---------	-----

C

Cobra Head	2-0, 2-12, 2-13
Complete Interchange Lighting	1-3, 1-7, A-1
Computer Programs	4-6, 4-44
Continuous Freeway Lighting	1-3, 1-7

D

Depreciation Factors	3-4
----------------------	-----

E

Electrical Distribution	4-6
Equipment	2-0, 2-12, 4-34

F

Footcandle	4-10
------------	------

H

High Mast	2-1, 2-10, 2-13, 2-14, 4-30
-----------	-----------------------------

I

Isofootcandle	3-2
---------------	-----

L

Lamp	2-3, 2-7, 3-0, 3-4, 4-12, 4-25, A-1
Lateral Light	3-3
Lighting Design	4-6, 4-30, 4-44, 5-1
Luminaires	1-4, 2-0, 2-1, 2-10, 2-11, 4-25, 4-26, 4-27

M

Median Barriers	1-4
-----------------	-----

P

Partial Interchange Lighting	1-3, 1-8, A-1
Photometrics	3-0
Poles	2-10, 2-11, 2-15

Q

Quality	1-2
---------	-----

R

References	B-1
Round	2-12, 2-13

S

Service Cabinet	2-15, 2-16, 2-17, 4-34
Shoobox	2-0, 2-1, 2-2, 2-12, 2-15
Special Provisions	5-1, E-1
Specifications	2-10, 5-1
Standards	5-1

T

Temporary Lighting	4-6, 4-44
Terms	1-1, A-1
Traffic Engineering Objectives	1-2

U

Underpass Lighting	1-3, 4-33
--------------------	-----------

V

Vertical Light	3-3
Vertical Mount	2-1, 2-10, 2-13, 2-14
Visibility	1-1, 1-2

W

Warrants	1-7, 1-9
----------	----------